



SKYLO

ULTRA20+ FLUSH PLATES



WARNING

We shall not be responsible or liable for any failure of, or damage to, this plumbing product caused by the use of chlorine/bleach cleaners or related products added to the tank water. Use of such products will void the warranty and may result in product failure, possibly causing property damage. Do not over tighten plastic nuts and always turn off water supply when installing / removing toilet cistern parts.

Please note: Save this instruction booklet for future reference. DO NOT use plumber's putty to seal any components of this product.

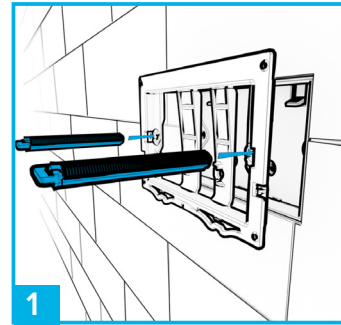
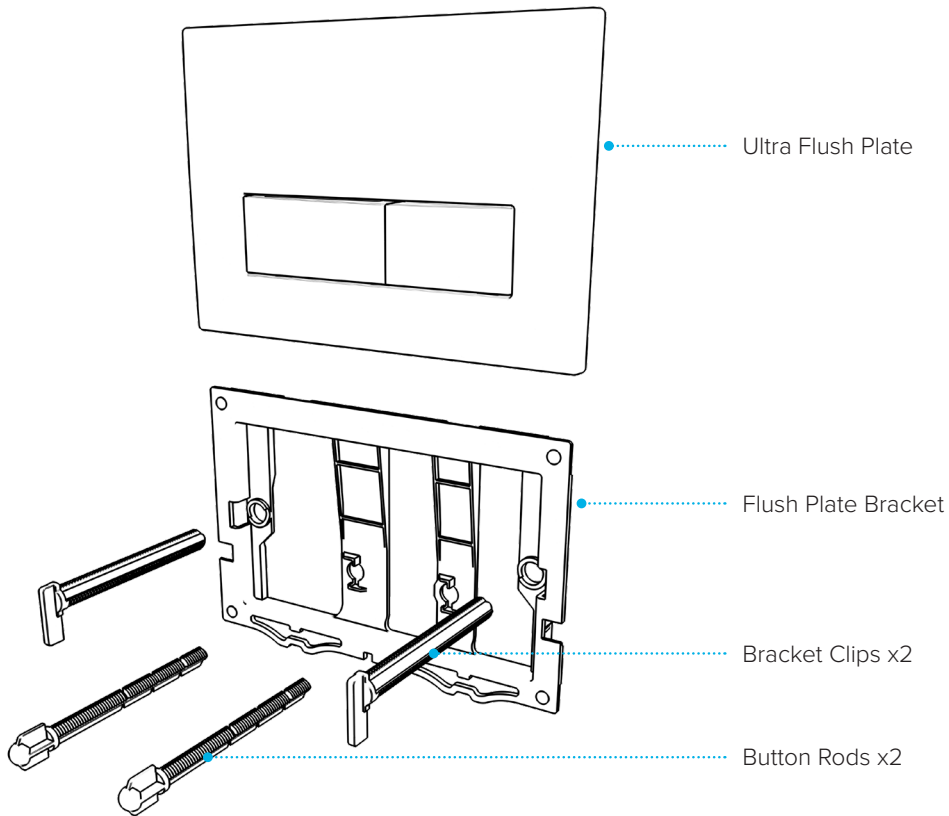

Attach the button bracket using the clips provided

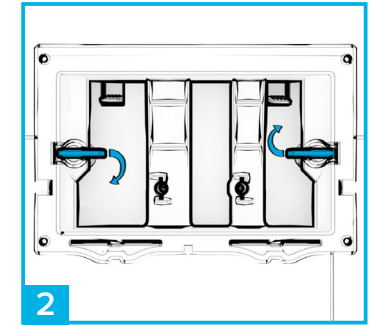

Rotate the bracket clips as shown to lock and secure the button bracket.

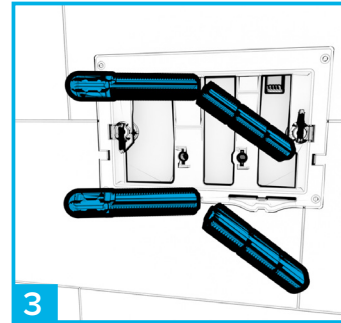

Depending on the depth of your wall, the central button rods may need breaking off before inserting into the inner holes.

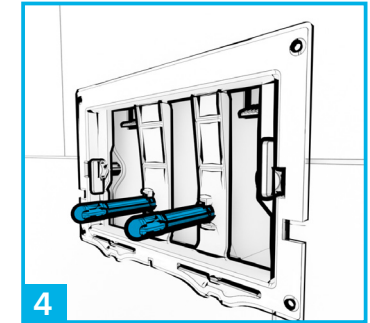

Insert and secure the central button rods by twisting them clockwise.

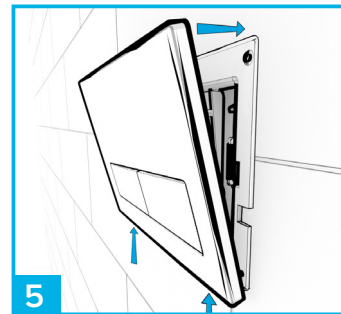

Apply the flush plate, firstly onto the lower spring clips and then return the top edge to the wall and allow to drop over the top edge of the button bracket.

For more information please contact:

VIVA Sanitary
Units 1-2 Capitol Trading Park, Kirkby Bank Road,
Knowsley Industrial Estate, Liverpool, L33 7SY

Tel: 0151 546 0531 Fax: 0151 549 4187
E-mail: sales@vivasanitary.co.uk