

# Installation Guide

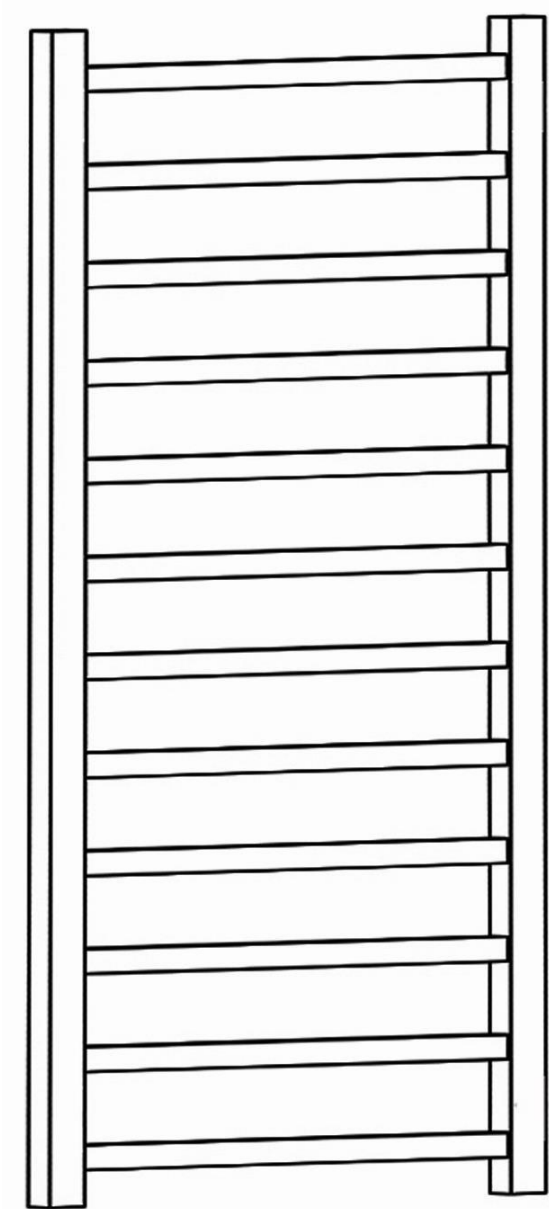

# Important information

Before installation, please read this guide carefully.

- A fully qualified and competent person should install this product.
- Observe all local plumbing and building codes.
- Shut off the main water supply.
- Operating temperature maximum 100°C. Please install a warning sign near the product to avoid burning and scalding accidents.
- Select the desired location for the radiator ensuring the chosen wall is both strong enough and suitable to carry the weight of the radiator when full of water.
- The provided fixings are for masonry walls only, if installing on any other surface please check that it will safely support the product and purchase suitable fixings
- When cleaning, never use abrasive cleaners on this product as they will damage the surface. Wipe the surface clean with a soft, damp cloth.
- Manufactured to BS EN 422-1 Radiators and convectors.
- The pipework must be flushed out to remove any debris which can affect the function of this product.
- We update our product information and instructions regularly: for the latest product information and instructions please look up your product by using search bar on the website [www.victorianplumbing.co.uk](http://www.victorianplumbing.co.uk)

---

## Child Safety Notices

Please note that you are 100% legally responsible for your own child's safety at home. Once installed, the radiator can become a hazard for children as this radiator is not designed to support unreasonable extra weight, such as that of a child and the radiator becomes hot during use. We must stress that you should not allow children to climb/grab/play with the radiator or rails, as this can cause accident or injury for the child from heat, falling, or the radiator being pulled off the wall.

---

## Check & Inspect

Here at Victorian Plumbing, we pride ourselves on selecting products from reputable manufacturers who manufacture to our exacting standards and quality control measures. All our products are well packaged and should reach you in pristine condition. Please check this product carefully prior to install as we must be notified of any shortages or damage within 30 days of delivery. For further information please see terms and conditions.

## Tools required for installation (not supplied)

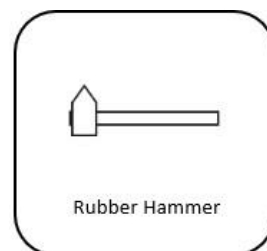
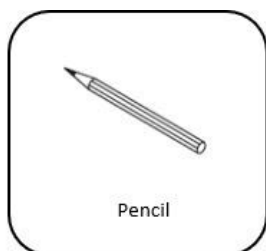

---

## Please check you have all the items below:

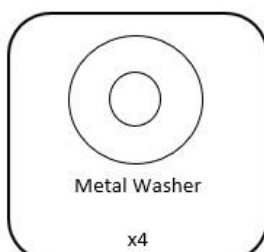
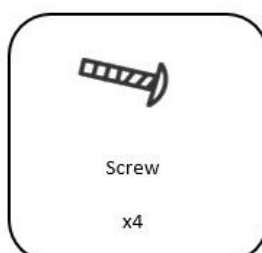
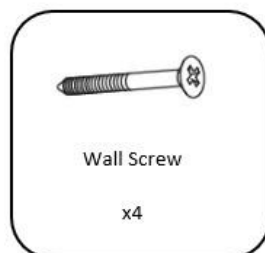
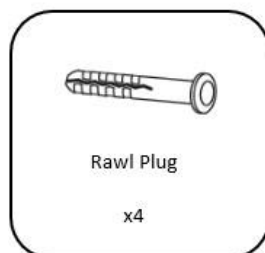
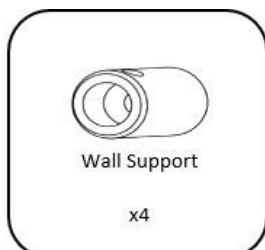
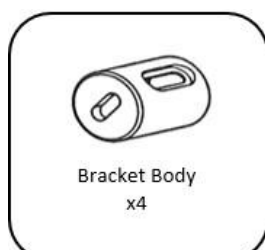

# Step 1

Connect the 4 long screws & bracket bodies to the towel radiator as below image.

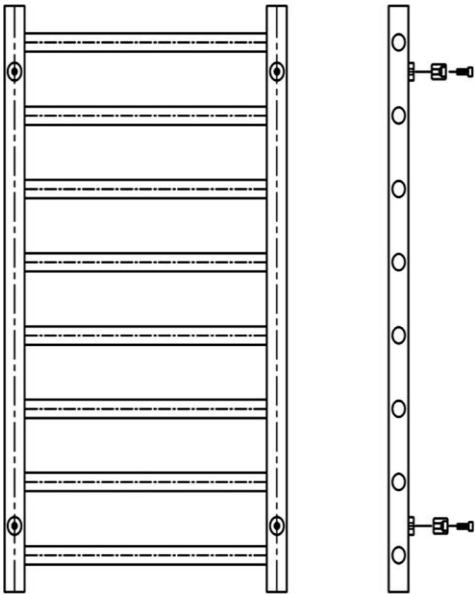

---

# Step 2

Position the towel rail in desired location. Check for level and mark the screw hole positions to be drilled for the brackets.

Make sure the towel rail is installed vertically.

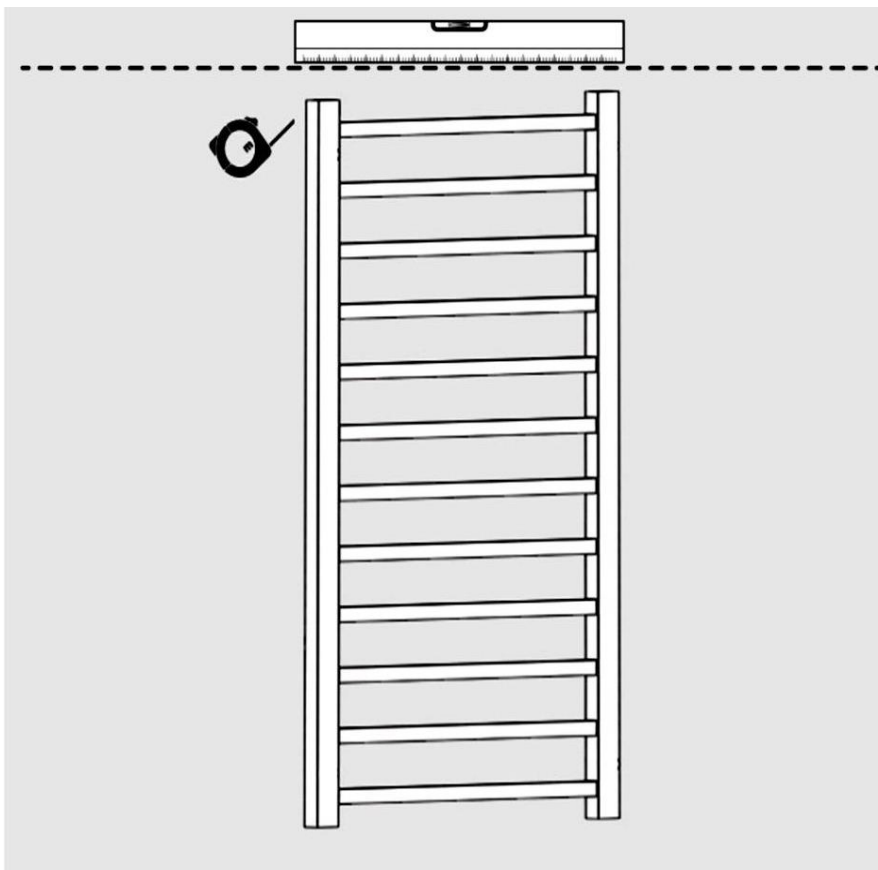

Allow enough room for the installation of valves or thermostatic controls.

Before installation place a dust sheet on the floor to prevent losing any small parts.

## Step 3

Using the correct sized masonry drill bit drill holes and insert wall plugs. For false or studded you may require different fixings and can be purchased from your local DIY store.

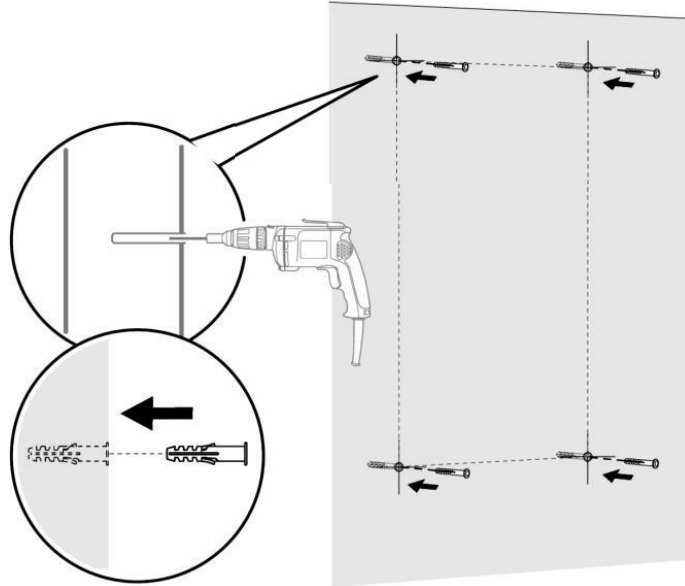

---

## Step 4

Fix all the wall supports to the wall as below image by using a screwdriver.

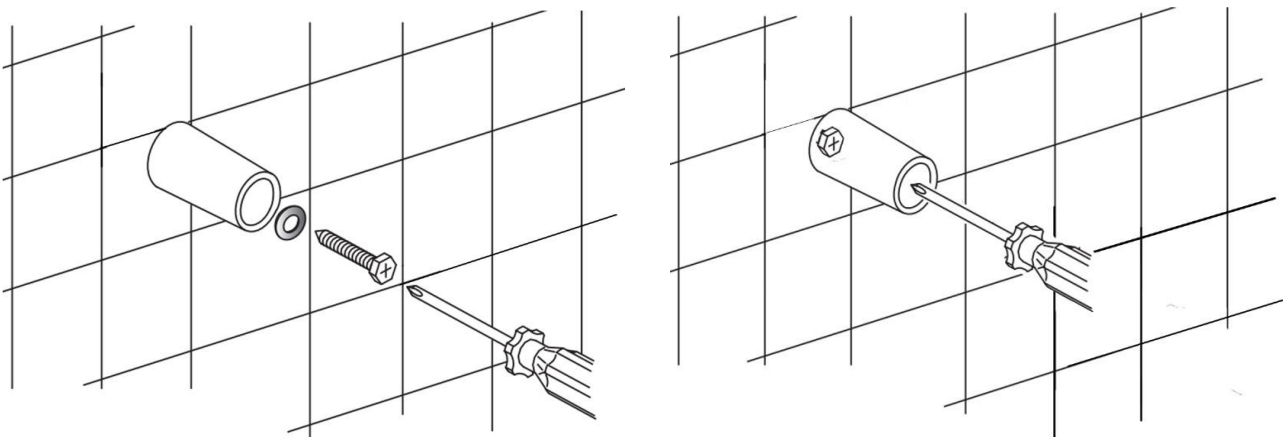

## Step 5

Wrap PTFE tape around the blanking plug and vent plug threads then proceed to insert into the top of the radiator tightening with a spanner.

Repeat the procedure and install the radiator valves in the bottom tapping's.

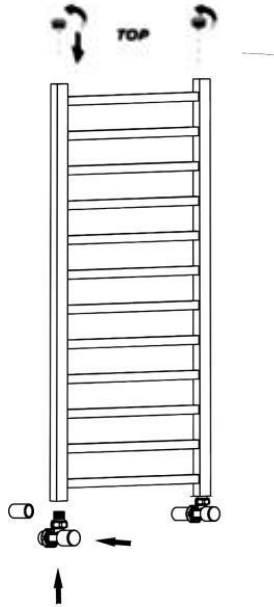

---

## Step 6

Slide the brackets into the wall supports and tighten all the screws when in the desired location. Be sure to check for level at all stages.

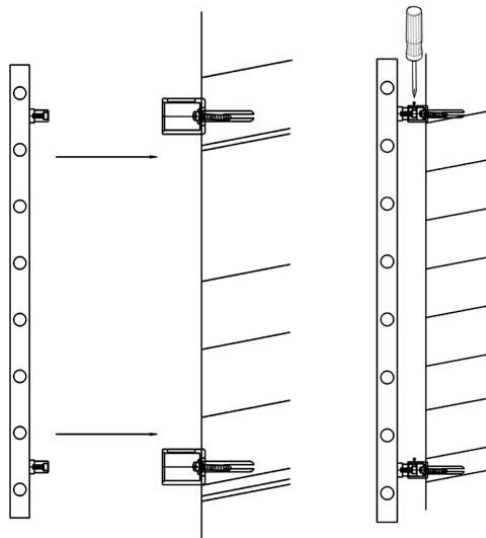

## After installation

- Use a screwdriver/vent key to open the air vent, open the valve and let the water rush into radiator.
- Check all connections for leaks.
- Once water overflows from the air vent, the radiator is fully purged of air.
- Use a screwdriver/vent key to close the air vent, turn on the valve and the radiator is ready for use.

---

## Recycling and disposal

Please recycle the packaging in accordance with your local government regulations on waste handling, and follow the same advice at the end of the products life.

Product - Steel

Packaging - Cardboard, plastic, steel

---

## Trouble shooting

When your radiator does not function, knowing basic radiator troubleshooting can save you from the stress and the hassles of a non-functioning radiator. Here is a guide to solve the most common problems associated with these electric home heaters.

Problem	Cause	Action
Cold spots on the radiator	Water is not flowing through radiator properly	<ul style="list-style-type: none"><li>• Check to make sure there is no trapped air inside the radiator. "Bleed" the radiator to release air.</li><li>• Make sure the valves are fully open to allow water to move freely.</li></ul>
Leak on the radiator	Valve nut is loose	Tighten the valve nut
Sound of whistling or water whooshing	Radiator was not perfectly balanced when it was installed	Re-balance all radiators on the heating system
Clanking sound	The radiator was installed in a space that does not allow for pipe expansion	Re-check pipework