

Angled Radiator Valve Installation Instructions

Before you Begin:

- This instruction shows how to fit the radiator valves. Ensure the valves are the correct size in conjunction with your chosen radiator.
- **We recommend that this product is installed by a qualified tradesperson**, Victorian Plumbing Ltd. accept no liability for products incorrectly installed, or where the correct testing procedures have not been adhered to, thus resulting in the escape of water and consequential damage.
- Ensure the incoming mains water supply is switched off prior to commencing the installation.
- Observe all local plumbing and building codes & regulations.
- Unpack the product then read these instructions before proceeding. Inspect the product for damage. If any damage is found, contact our Customer Relations team.

1 *Make sure that all components are present prior to installation.*

Fitting List:

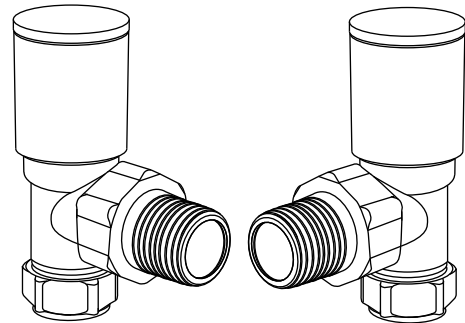

Angled Valves x2

Exploded Drawing:

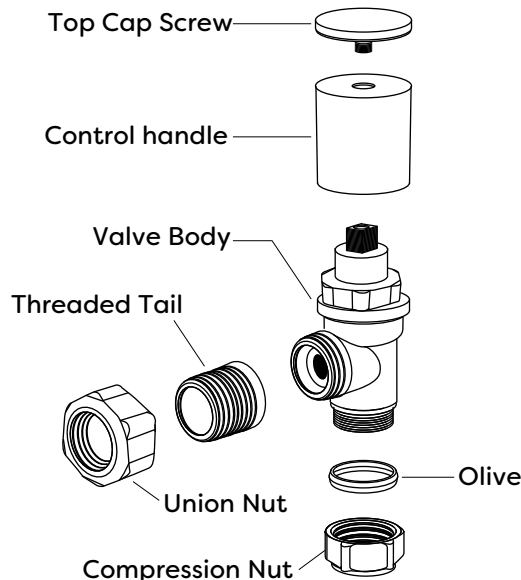

Tools Required (Not Included):

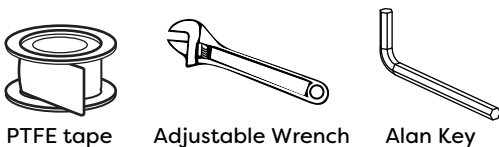

Note: Diagrams are for illustration purposes only. Your radiator valve may superficially differ from this drawing however the installation guide steps still apply.

Recycling and Disposal:

- Please recycle the packaging in accordance with your local government regulations on waste handling and follow the same advice at the end of the products life.

2

Before installation, drain down the heating system in preparation to connect to the radiator.

2a

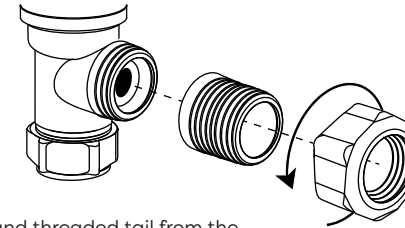

Unscrew the side union nut and threaded tail from the valve body. Wrap PTFE tape around the threaded tail to ensure a water tight seal.

2b

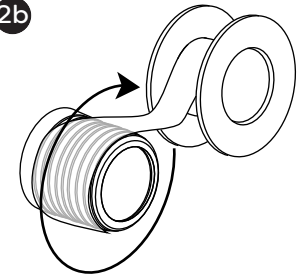

3

Unscrew the bottom compression nut and olive from the valve body. Slide the compression nut and olive over the metal pipe, then feed the metal pipe into the valve body. Secure the Piping to the valve body by screwing the bottom compression valve, tighten with a adjustable wrench.

3b

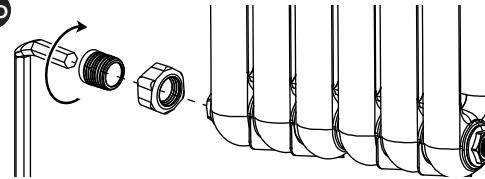

3c

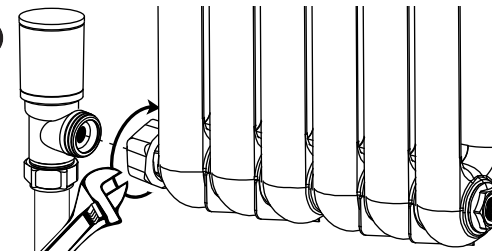

3a

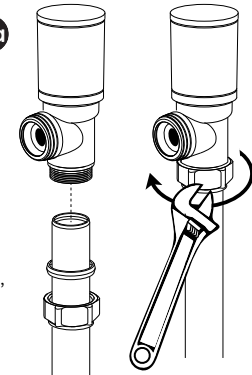

Feed the side union nut through the threaded tail, then screw the threaded tail to your chosen radiator. Secure the connection using an Alan key.

Connect the valve body to the threaded tail within the radiator and tighten the union nut using an adjustable wrench forming a water tight seal.

4

Turn on the central heating, open the radiator valves and bring the radiator to full heat. Once the radiator has reached maximum temperature wait another 5 minutes, check all joints and connections for any leaks.

Turn the radiator off. The device is ready to use.

Note: Turn the valves clockwise to open the valves, turn anticlockwise to close the valves.

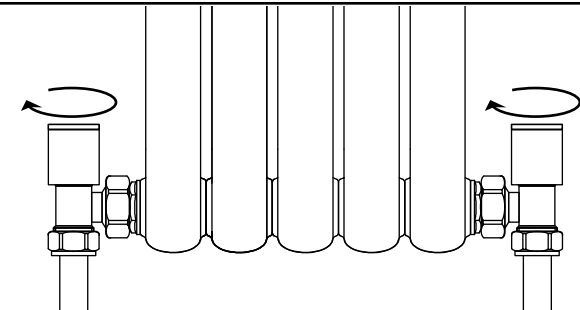

Cleaning and Aftercare:

- **Warning:** Do not use abrasives, scourers, bleach or any type of chemical cleaning solution when cleaning the radiator valves. It is recommended to use warm soapy water and a clean damp cloth.

For more information visit: www.victorianplumbing.co.uk