

S H O W E R
W A L L

COMPACT

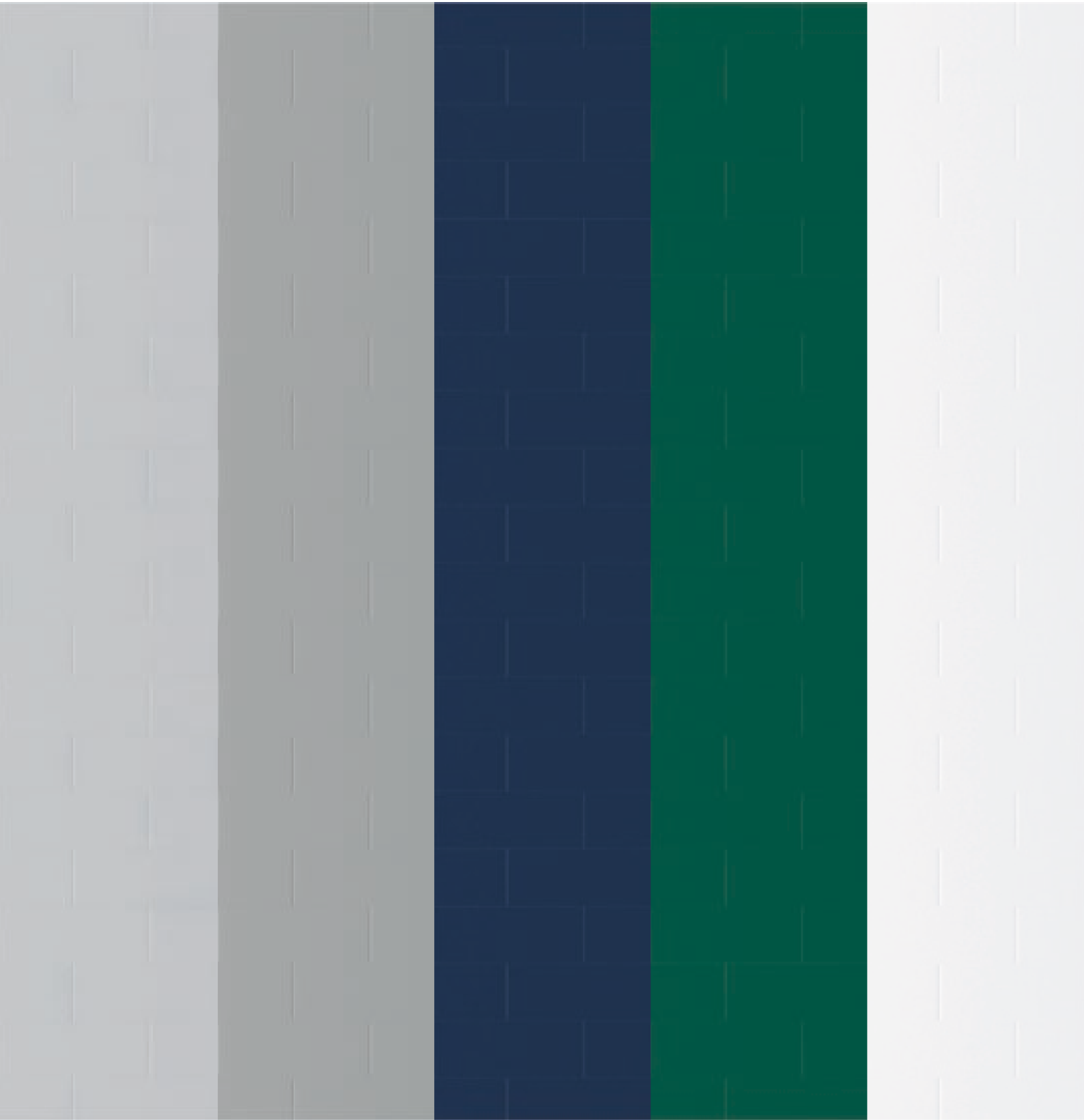

CONTENTS

It is essential to read this guide thoroughly before commencing installation.

- 04** **INSTALLER RESPONSIBILITY**
Important do's and don'ts and a pre installation checklist
- 06** **PREPARATION**
Preparation advice for fitting panels
- 08** **SECTION ONE**
Installation steps for two sided shower enclosures
- 09** **SECTION TWO**
Installation steps for three sided shower enclosures
- 10** **SECTION THREE**
Details for working with window reveals
- 12** **SECTION FOUR**
Advice for the cleaning and maintaining the installed Showerwall product. Plus a summary of the guarantee; full version available at www.showerwall.co.uk

INSTALLER RESPONSIBILITY

Installation Details

IMPORTANT DETAILS

Prior to commencing installation please carefully read this installation guide in full. It is important that you follow and adhere to all of the instructions to ensure the most effective use of the product.

To maintain the validity of your guarantee you must follow the installation instructions provided. Failure to do this will make all aspects of the guarantee invalid. The product colours/décor should be confirmed as acceptable by the consumer/end user prior to installation by the installer.

If there is any aspect of your particular installation that these instructions do not cover please clarify any queries before commencing your installation via the Showerwall helpline; **0845 604 7334**.

Your particular installation may require specific procedures and adjustments.

NOTE: Within the product packaging is an envelope for the property owner, containing the guarantee registration card and a care/maintenance sheet.

PLEASE DO

Do always store Showerwall panels flat to prevent bowing.

Do acclimatise the product prior to installation in normal heated conditions, 24 hours.

Do use the Showerwall sealant and adhesive.

Do ensure the Showerwall sealant is applied correctly at all stated points.

Do closely inspect each panel for surface defects prior to and during installation.

Do give the enclosed owner guarantee registration documents to the owner of the property.

Do handle the panels carefully to avoid damage to the profiled edges.

PLEASE DON'T

Don't store the panels outside or in wet / humid conditions.

Don't store the panels propped against a wall on edge or end.

Don't use abrasive cleaners and bleaches to clean the panels.

Don't fit Showerwall panels without correctly sealing every joint.

Don't throw away the owner guarantee registration documents.

Should you find any defects, do not continue the installation.

Please refer your concerns to your supplier immediately who will assist with the problem.

Before You Start

CHECK APPEARANCE

Panels are supplied boxed. Always check for any visual defects prior to installation. Any claim for visual defects present in the panels after fitting will not be covered by the associated guarantee.

Also check each panel for profile edge damage. The panel face protective film should always be removed prior to installation so that the surface can be appropriately checked.

Due to the printing process involved, slight colour variations may be found between panels and are not grounds for complaint. Decor patterns are random/unmatched.

Once the panels have been installed they are deemed to be acceptable in relation to any visual defects.

A guide to installation is available to view via the Showerwall website. However, as a guide only, these instructions must be used for the actual installation.

INSTALLATION COMPONENTS

Components and Fittings

AVAILABLE COMPONENTS

Ensure that you have all components required for your particular installation. This includes your Showerwall panels of choice and all applicable panel trims;

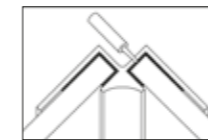

Internal Corner
Used on all internal 90° corners.

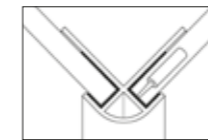

External Corner
Used on all external 90° corners.

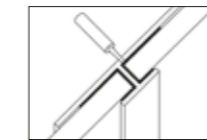

Joining Trim
Used to mount panels side by side.

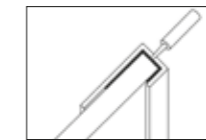

End Trim
Finishing end trim for panels.

Accessories available, black, white, satin silver, polished finishes.

RECOMMENDED TOOLS

In addition to the supplied Showerwall profile we recommend the following tools for installation;



Safety Glasses



Safety Gloves



Dust Mask



Circular Saw



Safety Footwear



Measuring Tape



Spirit Level



Jigsaw



Drill



Sawhorse / Bench



Combination Square

ADHESIVE, SEALANTS & CLEANERS

We recommend that Showerwall's own brand products should be used for the effective fitting, sealing and maintenance of your Showerwall system. The use of any alternative products may invalidate your guarantee.

For a 1000mm wide panel, use one cartridge of Showerwall adhesive for fixing the panel to your wall and two cartridges of Showerwall sealant for sealing the edges of the panel.

Compact panels can be coordinated with our silicone sealants as outlined below:



White Sealant for Lily White



Grey Sealant for Silver & Dove Grey



Emerald Green Sealant for Hunter Green



Navy Sealant for Midnight Blue



Showerwall Adhesive

High grab, high bond strength MS Polymer based superior panel adhesive.

Showerwall Sealant

Fast curing, low modulus, easy to smooth wall panel and sanitary ware sealant.

Showerwall Superclean

A non abrasive, pH neutral, anti bacterial, streak free cleaner.

Please Note: the sealant colours mentioned above are just a recommendation and aren't a direct colour match.

PREPARATION

PANELS

Showerwall compact tile panels must be fitted to a continuous surface such as plaster board, existing tiling, plywood or tile backer boards providing the surface is sound, plumb and level. Some surfaces do require pre-treatment before installation, tiles should be de-greased and fresh plaster should be sealed with a proprietary PVA sealer.

A 3mm-4mm gap should be left at the top and the bottom of the panel achieved using spacers, the gap then filled with showerall silicone sealant. This allows the bath or shower tray to expand and contract.

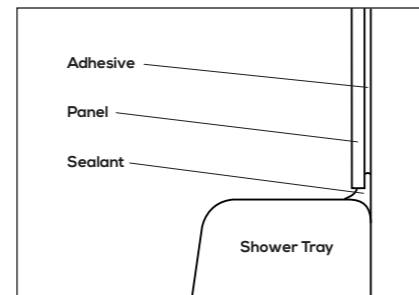

PANEL ALIGNMENT

The 3mm composite panels are produced with a tile effect pressed into the face, due to the manufacturing and trimming processes it is not always possible to ensure that the pattern is identical on every panel.

It is therefore sometimes necessary to trim the panels prior to installation to ensure that the tile joints are aligned and square to any edges that are to be joined.

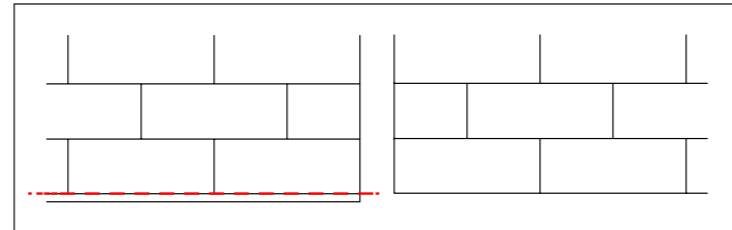

CUTTING ADVICE

For best results use a plunge saw fitted with an appropriate rail guide to protect the panel.

Always cut the panel decorative side face up on a flat supported surface, using clamps secure the panel in place and transfer your cutting marks to the panel, use of masking tape is ideal for this. If using a circular saw cut the panel decorative face down into a sacrificial board.

Set your saw depth to 4mm material depth (to include rail dimensions). Use of a brand new blade will help to avoid excessive chipping and chattering, fine (48 minimum) teeth triple chip blades are ideal for cutting your compact Showerwall panels.

Cut in one single pass, 3000-4500rpm in a slow measured action ensuring debris does not clog the blade, use of extraction is advised!

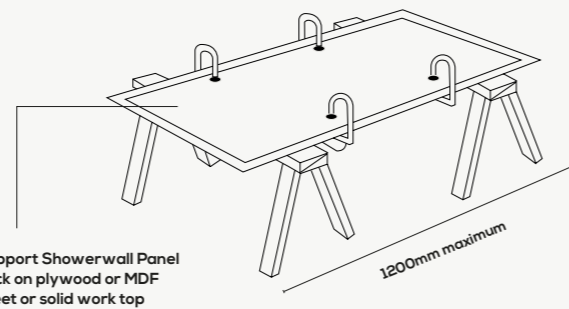

PREPARATION

DRILLING

All standard wood working tooling such as drill bits and holes saws can be used on the Showerwall compact panels. When drilling, a slow speed should be selected and the panel must be fully supported below/behind, this will prevent the panel from cracking. The edges of the hole should then be de-burred.

CUT-OUTS

Shaped cut-outs can be formed by drilling 8mm diameter holes in the corners of the required shape and then cutting between using a jigsaw with a fine blade. Support the panel at all times during cutting and handling. With all cut outs a radius of at least 4mm must be left in the corners failure to do this can lead the panel to cracking.

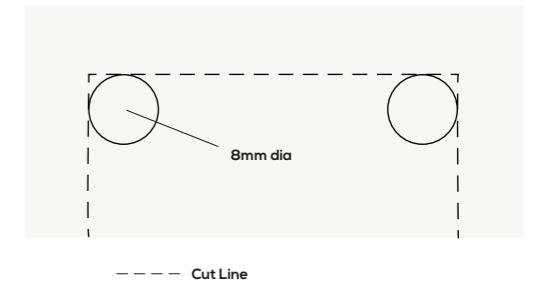

ADHESIVE

When offering the panels to the wall, the use of your straight edge will ensure sufficient force is used. This will ensure correct adhesion of your panel to the wall with your Showerwall panel adhesive. Failure to do so could result in insufficient adhesion of your panel to your wall and void your warranty.

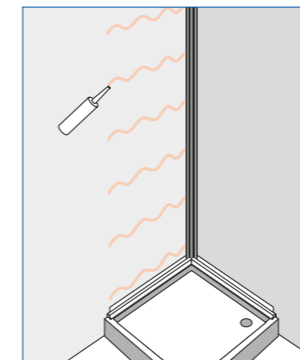

NOTE: When fixing to tiles, conduct the same adhesive application method in conjunction with using Showerwall sealant as the fixing adhesive. Use one sealant tube to fix each panel.

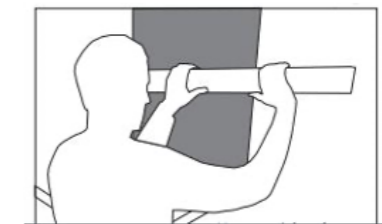

HANDY HINTS

Always leave the front protective film on the front of your panel until the very last. This should be the last job after you have cleaned up your construction site. When pushing your panel against a wall, use a straight edge as this will ensure you have a nice flat installation rather than one that follows the contour of an uneven wall. Use the packaging your panel came in to make up a template for cutting your sheet. Use tile spacers to give you the correct spacing between sheets and your shower tray.

When cutting your Showerwall compact panel always cut through into a sacrificial board as this will help prevent vibration and chatter when cutting. You can use small pieces of double sided tape to hold your panel in place while your panel adhesive cures.

SQUARE EDGE PANELS

Section One

TWO SIDED SHOWER

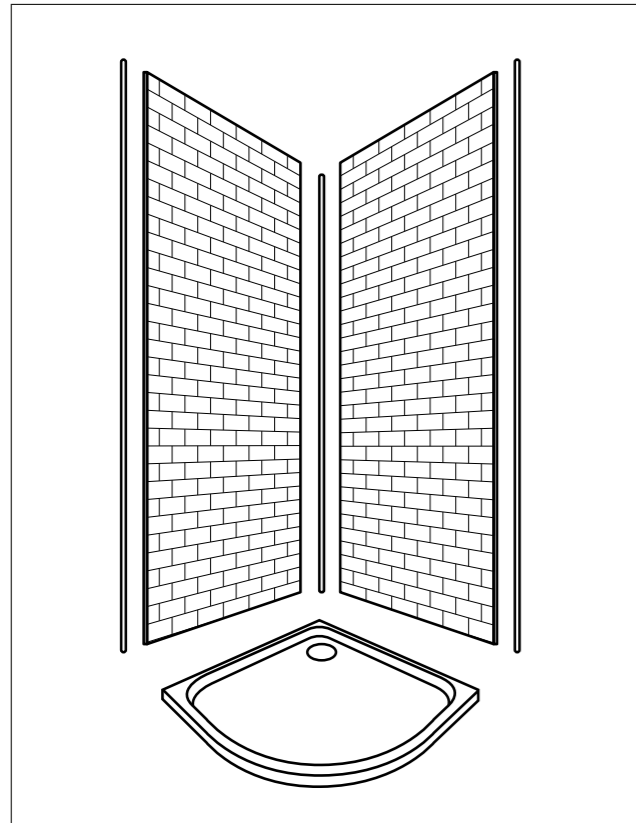

- One**
Assuming the panels have been cut to size and dry fitted. Peel back the protective film about 25mm vertically, apply a bead of Showerwall silicone into one side of the internal corner trim.
- Two**
Make sure 3-4mm spacers are in place on top of the shower tray.
- Three**
Apply Showerwall panel adhesive to the rear of the panel and press the panel to the wall.
- Four**
Apply a bead of Showerwall silicone into the end trim and slide into place on the outside edge of the panel.
- Five**
Repeat steps 3 & 4 for the 2nd panel.
- Six**
Seal the bottom edge of the panel ensuring Showerwall silicone adequately fills any gaps, any apertures around pipework can now be filled with Showerwall silicone.

SQUARE EDGE PANELS

Section Two

THREE SIDED SHOWER

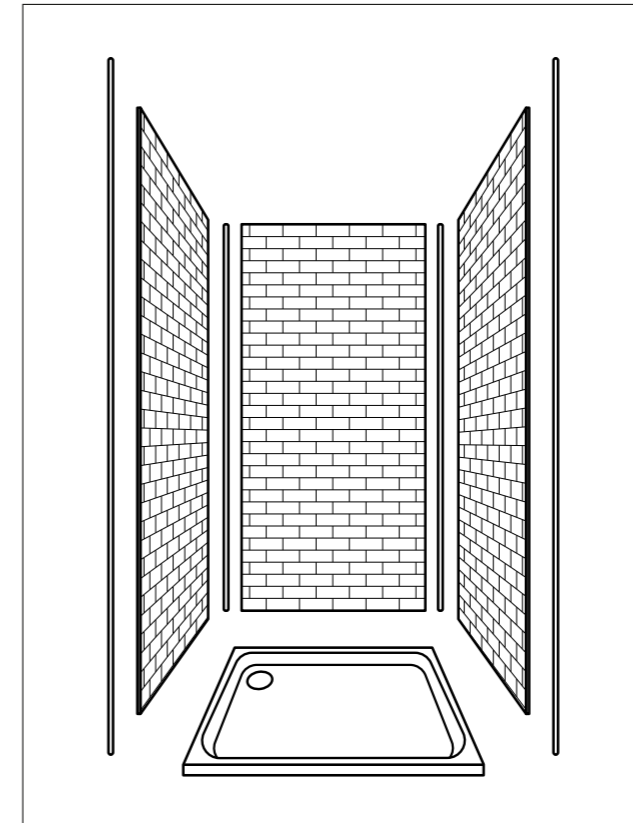

- One**
Assuming the panels have been cut to size and dry fitted. Fit both the internal corner trims 1st.
- Two**
Peel back the protective film about 25mm vertically, apply a bead of Showerwall silicone into one side of the internal corner trims.
- Three**
Make sure 3-4mm spacers are in place on top of the shower tray.
- Four**
Fit the back panel 1st.
- Five**
Apply Showerwall panel adhesive to the rear of the panel and press the panel to the wall.
- Six**
Apply more Showerwall silicone into the remaining channels on the internal corner trims.
- Seven**
Apply Showerwall panel adhesive to the rear of the panel and press the panel to the wall.
- Eight**
Repeat for the remaining panel.
- Nine**
Seal the bottom edge of the panel ensuring Showerwall silicone adequately fills any gaps, any apertures around pipework can now be filled with Showerwall silicone.
- Ten**
In wet areas the panels require to be 3-4mm from the final floor surface and the resulting gap filled with Showerwall silicone. (please ensure any tanking material overlaps to the rear of the Showerwall composite panel).

SEALING PIPES, HOLES & CUT OUTS

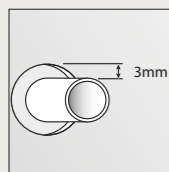

When cutting out or drilling holes into your panels to accommodate pipes or shower units, ensure a clearance space of 3mm width is left between the fixed object being cut around and the panel edge.

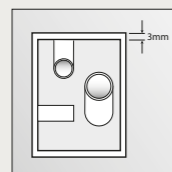

The 3mm clearance space must then be fully filled with Showerwall sealant once the panels are installed and before any fittings or shower units are fitted.

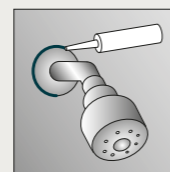
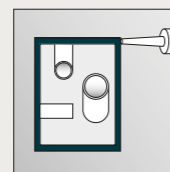
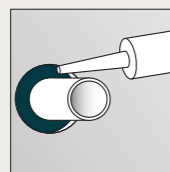

Following the fitting of any shower units or pipe collars etc. always seal the shower unit casing or pipe collars again to ensure a further watertight seal exists externally around the unit / collars.

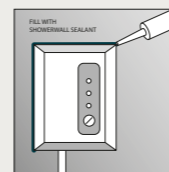

Note: Failure to adequately seal any cut edge sections of the panel may result in unwanted water ingress behind the panels and will invalidate your product guarantee. Fixing items through the panels. Noting that the panels are not structural and the fixing load should be fully secured in the supporting substrate. (radiators, shelves, shower screens, handles).

SQUARE EDGE PANELS

Section Three

WINDOW REVEALS

Use the Showerwall external trim for each external corner point around your window reveal.

Ensure all trims are fixed with Showerwall adhesive and all trim recess are filled with Showerwall sealant prior to installing the panel sections.

Measure and cut the final panel sections ready for installation. Dry fit each section to ensure correct angles, sizes and a neat fit.

Measure and compound mitre cut each section of external corner trim as required. Ensure the trim is placed in the mitre box correctly so that the correct compound angle is achieved.

Once the trims have been correctly mitre cut to length and checked for accurate fitting, fix the trims in place using Showerwall adhesive in the same manner previously detailed.

Next, apply Showerwall adhesive to the window reveal wall sections in the same manner as detailed in step 3 of section 1.

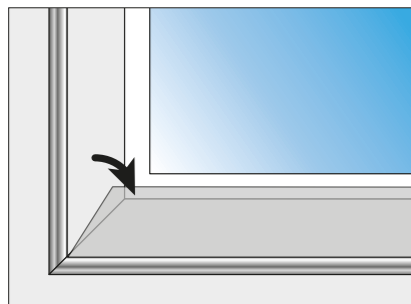
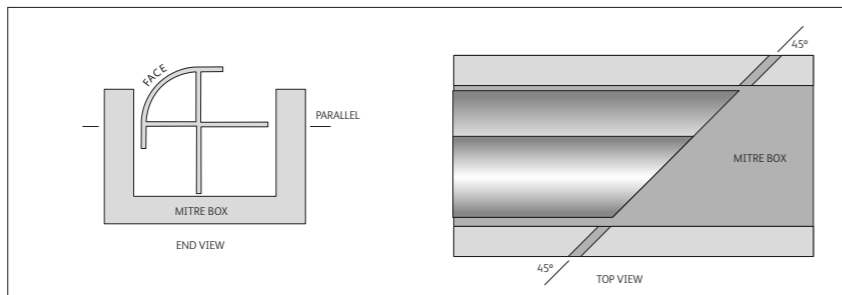
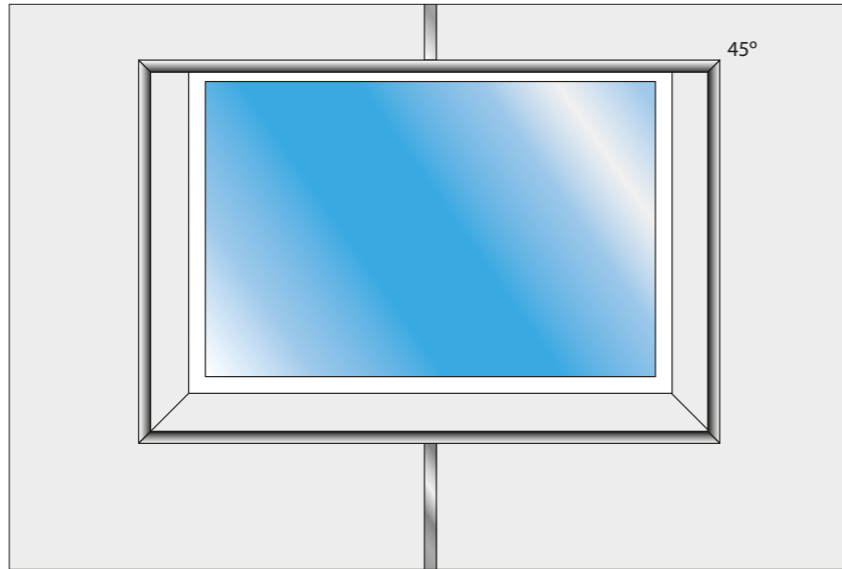

Install the two horizontal (top and bottom) sections first by inserting the panel into the trim recess at an angle ensuring that it is then fully pushed onto the adhesive.

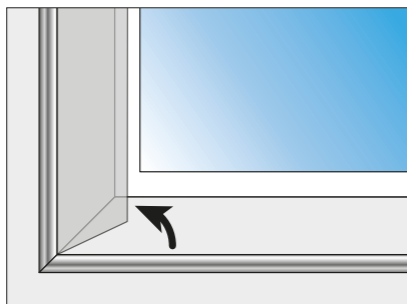

Proceed on installing the two vertical (sides) sections using the same method.

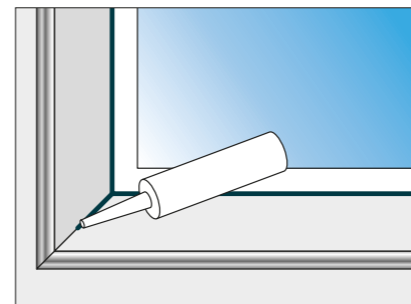

Complete the installation by applying Showerwall sealant across the top and bottom corner (joints and rear) edges that meet the window frame.

Windows and door frames can be capped off using the external corner trim or the end trim dependent on requirement.

Simply peel back any remaining protective film add a bead of Showerwall silicone to the trim and slide into place, repeating as necessary.

CARE, MAINTENANCE & GUARANTEE DETAILS

Section Four

CARE

The non-porous surface of Showerwall provides excellent protection against bacteria and is easily cleaned and maintained.

Showerwall Superclean is a non-abrasive, pH neutral cleaner specifically formulated and tested for use with your Showerwall panels and will achieve a streak free finish on Showerwall, Glass, Sanitaryware, Taps & Plastics.

It kills bacteria viruses, mould and has a sterilising affect on your Shower area keeping the surfaces clean without scratching and is recommended for the optimum life and performance of your Showerwall panel system.

Your Showerwall panels should be rinsed down after each use of your shower and cleaned using Showerwall Superclean. Not rinsing away chemicals such as hair dyes or hair bleaches may have a discolouring affect on the Showerwall sealants.

Please ensure the property owner retains this section for future reference.

GUARANTEE

Showerwall panels will be free from defects caused as a direct result of faulty manufacture for the period of thirty (30) years in the case of panels installed in a domestic environment, and five (5) years in the case of panels installed in a commercial environment.

Note the 30 year term of the guarantee for panels installed in a domestic environment is only applicable when the purchase of the panels has been registered within 28 days of the installation of such panels. In the event that the purchase of the panels is not registered within the 28 Days, the Guarantee Period for panels that have been installed in a domestic environment will be fifteen (15) years from the date of invoice.

Registration of the purchase of the panels can be made online via www.showerwall.co.uk or by returning the registration document contained within the product packaging.

This guarantee is only valid and applicable where the Showerwall system installation is fully in accordance with these set of instructions. No guarantee is offered where the installation is not in accordance with these instructions or is a unique or bespoke form of installation. Please contact Showerwall if any queries exist in relation to your particular installation.

A copy of the complete guarantee document is available upon request or can be downloaded at www.showerwall.co.uk.

MAINTENANCE

Any exposed bottom edge sealants may need to be replaced periodically, and or as necessary dependant up on shower usage and normal sealant degrade, and is a normal good maintenance procedure. Failure to maintain exposed sealants as necessary may result in water ingress into the panel core and subsequent panel damage and will invalidate your guarantee.

Any exposed bottom edge sealant beads can be replaced using the Showerwall silicone eater accessory, which assists in the easy removal of your old sealant beads prior to resealing with new Showerwall sealant.

Showerwall Silicone Eater is available via your Showerwall supplier.

NOTE: Abrasive cleaners or bleaches must not be used on the panelling.

INSTALLATION DATE	PANEL BATCH NO.
INSTALLER DETAILS	

**Naturally inspired
surfaces**

T: 0845 604 7334

E: info@showerwall.co.uk

www.showerwall.co.uk | 2022-V2

