A modern bathroom vanity setup. The wall is covered in a light-colored terrazzo laminate with small, multi-colored speckles. A large, round, black-framed mirror is mounted on the wall. Below the mirror is a white rectangular sink on a white countertop. The vanity cabinet is made of light-colored wood with two drawers. To the right of the sink is a small vase with white flowers. Above the sink are three dark-colored knobs. Two pendant lights with clear glass shades and gold-colored bases hang from the ceiling. A shower glass door is visible on the right side of the image.

S H O W E R
W A L L

LAMINATE



INSTALLATION GUIDE

It is essential to read this guide thoroughly before commencing installation.

- 04 **INSTALLER RESPONSIBILITY**
Important do's and don'ts and a pre installation checklist.
- 06 **SECTION ONE**
Preparation advice for square click panels
- 07 **SECTION TWO**
Installation steps for Sureseal
- 08 **SECTION THREE**
Installation steps for two sided shower enclosures
- 09 **SECTION FOUR**
Installation steps for three sided shower enclosures and sealing instructions
- 11 **SECTION FIVE**
Preparation advice and installation steps for Proclick panels.
- 18 **SECTION SIX**
Advice for the cleaning and maintaining the installed Showerwall product. Plus a summary of the guarantee; full version available at www.showerwall.co.uk

INSTALLER RESPONSIBILITY

Installation Details

IMPORTANT DETAILS

Prior to commencing installation please carefully read this installation guide in full. It is important that you follow and adhere to all of the instructions to ensure the most effective use of the product.

To maintain the validity of your guarantee you must follow the installation instructions provided. Failure to do this will make all aspects of the guarantee invalid. The product colours/décor should be confirmed as acceptable by the consumer/end user prior to installation by the installer.

If there is any aspect of your particular installation that these instructions do not cover please clarify any queries before commencing your installation via the Showerwall helpline; **0845 604 7334**.

Your particular installation may require specific procedures and adjustments.

NOTE: Within the product packaging is an envelope for the property owner, containing the guarantee registration card and a care/maintenance sheet.

PLEASE DO

Do always store Showerwall panels flat to prevent bowing.

Do acclimatise the product prior to installation in normal heated conditions, 24 hours.

Do use the Showerwall sealant and adhesive.

Do ensure the Showerwall sealant is applied correctly at all stated points.

Do closely inspect each panel for surface defects prior to and during installation.

Do give the enclosed owner guarantee registration documents to the owner of the property.

Do handle the panels carefully to avoid damage to the profiled edges.

PLEASE DON'T

Don't store the panels outside or in wet / humid conditions.

Don't store the panels propped against a wall on edge or end.

Don't use abrasive cleaners and bleaches to clean the panels.

Don't fit Showerwall panels without correctly sealing every joint.

Don't throw away the owner guarantee registration documents.

Should you find any defects, do not continue the installation.

Please refer your concerns to your supplier immediately who will assist with the problem.

Before You Start

CHECK CONTENTS

Where a Showerwall installation kit has been purchased check the items in the kit system you have received against the list of contents contained in the kit and check that all items are of acceptable quality to use. Showerwall installation kits are solely for use when installing a 2 sided panel system. For a 3 sided installation further accessories will be required.

In the unlikely event that any items are not present, please contact your Showerwall retailer immediately. Showerwall will not be responsible for any claims for labour or downtime costs in such circumstances.

CHECK APPEARANCE

Panels are supplied boxed. Always check for any visual defects prior to installation. Any claim for visual defects present in the panels after fitting will not be covered by the associated guarantee.

Also check each panel for profile edge damage. The panel face protective film should always be removed prior to installation so that the surface can be appropriately checked

Due to the printing process involved, slight colour variations may be found between panels and are not grounds for complaint. Decor patterns are random/unmatched.

Once the panels have been installed they are deemed to be acceptable in relation to any visual defects.

These instructions are for a typical 2 sided shower installation. Refer to the additional info for 3 sided or full wall lining installations.

A guide to installation is available to view via the Showerwall website. However, as a guide only, these instructions must be used for the actual installation.

INSTALLATION COMPONENTS

Components and Fittings

AVAILABLE COMPONENTS

Ensure that you have all components required for your particular installation. This includes your Showerwall panels of choice and all applicable panel trims;

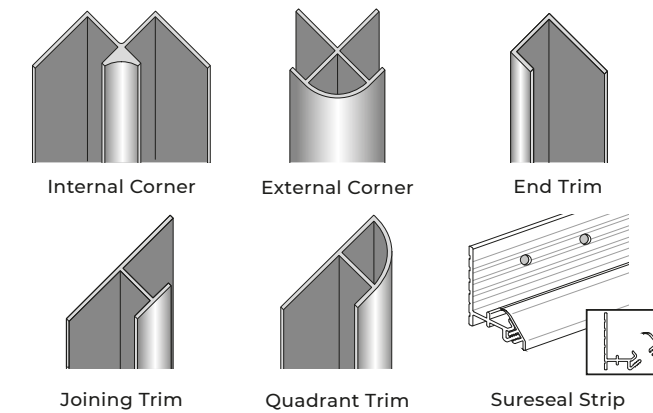

RECOMMENDED TOOLS

In addition to the supplied Showerwall profile we recommend the following tools for installation;

Tape Measure	Drill
1200mm Spirit Level	Sealant Gun
Handsaw*	Masking Tape
Utility Knife	Suction Grips
Hacksaw	Protective Gloves
Circular Saw*	Protective Goggles
Jigsaw*	Ear Protection

* fine toothed blade

Please ensure all tools are used safely and correctly and appropriate safety wear such as gloves, eye and ear protection are used.

ADHESIVE, SEALANTS & CLEANERS

We recommend that Showerwall's own brand products should be used for the effective fitting, sealing and maintenance of your Showerwall system. The use of any alternative products may invalidate your guarantee.

For a 1000mm wide panel, use one cartridge of Showerwall adhesive for fixing the panel to your wall and two cartridges of Showerwall sealant for sealing the edges of the panel and when using Sureseal strip.

Showerwall Adhesive

High grab, high bond strength MS Polymer based superior panel adhesive.

Showerwall Sealant

Fast curing, low modulus, easy to smooth wall panel and sanitary ware sealant.

Showerwall Superclean

A non abrasive, pH neutral, anti bacterial, streak free cleaner.



NOTE: Where the Sureseal strip is not used, exposed bottom edge sealants may need to be replaced periodically or as necessary dependant upon shower usage and normal sealant degrade. This is normal maintenance procedure. Failure to maintain any exposed sealants as necessary may result in water ingress and subsequent panel damage, not covered by the product guarantee.

Section One

MEASURE & MARKING

Ensure to check all panels for visible defects before cutting and during installation. Once the panels have been cut they have been deemed acceptable/fit for installation.

Showerwall panels have sharp corners and edges - therefore gloves should be worn at all times when handling or fitting panels. Appropriate Personal Protection Equipment such as safety eyewear should be worn when cutting the panels.

Measure and mark your required cutting line. If your panels are to be installed full height to ceiling level, cut the height of the panel to allow a 3mm expansion gap at the ceiling point which will be filled with Showerwall sealant on completion.

NOTE: Always consider and allow for the specified trim dimensions when cutting the panelling to size.

The below drawings are not to scale. Trim dimensions and thickness tolerance +/- 0.15mm

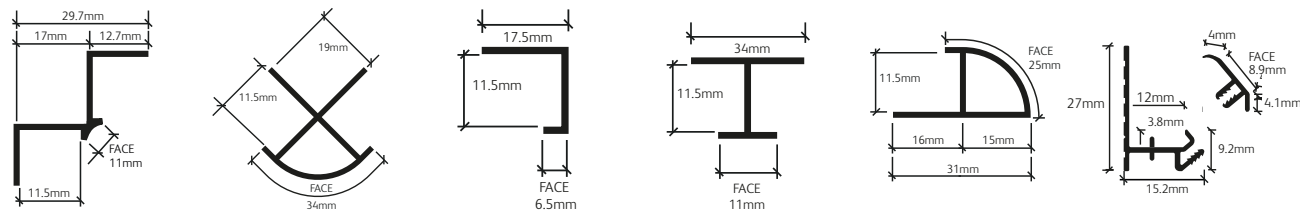

Internal Corner External Corner End Trim Joining Trim Quadrant Trim Sureseal Strip

WALL PREPARATION

Fixing Square Edge Panels to tiles, plasterboard or plastered wall. For ProClick panels please see section 5 on timber batten installation method.

If fixing panels to the walls without timber battens it is essential that all walls are sound, plumb, completely dry, dust free and clean before applying the Showerwall panels. Any source of dampness must be treated before fixing. If fixing direct to a tiled surface it must be sound and degreased first. Seal new or friable/dusty plaster walls with an appropriate PVA sealer to ensure a sound dust free surface.

Before installing the panels, check the walls carefully for high spots and remove any tiles that may interfere with the panels upon installation, for example; tiles that may create a warped finish. Loose or unsound tiles should be removed before installation.

Ensure the shower tray is also located level using a spirit level.

If the walls are uneven and out of plumb, battens must be installed as a frame support system. When fitting battens, they must be at a fixed level, plumb and square.

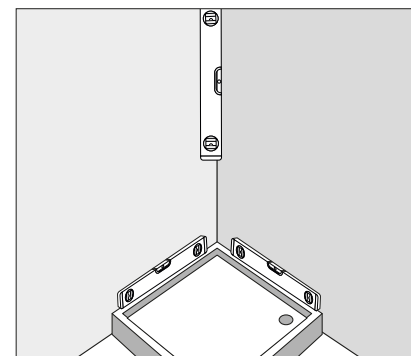

Any unsound or out of plumb tiled, plastered wall should have appropriate remedial work conducted to ensure the substrate meets the set standard for the installation as stated previously.

CUTTING

When using a fine-tooth blade handsaw, panels should be cut decorative face up. When using a jigsaw or circular saw with an upward cutting blade, the panels should be cut from the back, decorative face down to prevent chipping of the laminate surface.

NOTE: Ensure your tool blade always cuts into the decorative face to avoid chipping the laminate surface.

When using Sureseal the height of the panel should be taken from the top of the base trim's flexible nib (A) to the ceiling.

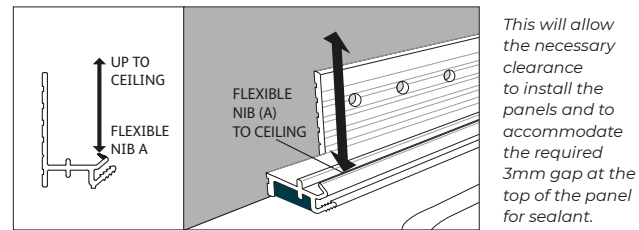

This will allow the necessary clearance to install the panels and to accommodate the required 3mm gap at the top of the panel for sealant.

Section Two

SURESEAL COMPONENTS

Sureseal is a 3-part-system for installations straight onto shower trays. This consists of a 2-part PVC strip and Showerwall sealant. Please skip to the next section if you are not using Sureseal.

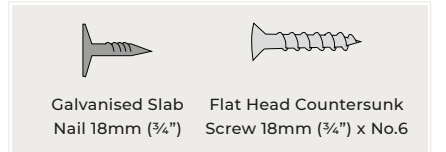

INSTALLATION STEPS

One

Place the Sureseal strip (ensure the front face capping trim is attached) into the Showerwall kit mitre box' and mitre cut the right hand end of the Sureseal strip. Position the mitred end of the Sureseal strip in place and measure, mark and cut the Sureseal strip to length to suit your particular shower tray / bath allowing for your shower cubicle frame width.

Repeat this process for your second Sureseal strip. Ensure that the two mitre cut ends meet neatly at the corner. Remove the face capping section from the base trim. Next measure, mark and notch (cut out) a section of the upper back flange of the Sureseal strip to accommodate the internal corner trim at the mitre end and the panel end trim at the opposite end of the Sureseal strip.

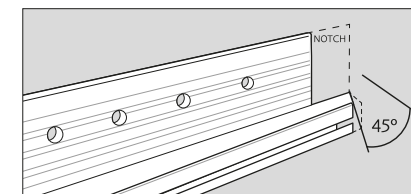

Two

Correctly position the Sureseal strips to ensure the mitre cuts and notches match. With the strips in position, lightly mark the shower tray/bath ledge (at multiple points with a pencil) to define the outer edge of each strip.

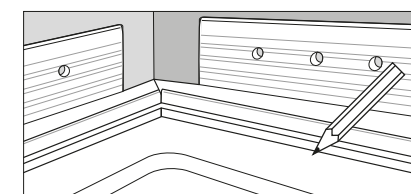

Three

If the front edge of the Sureseal strips are not resting flat on the shower tray /bath ledge, score and tear off the removable back leg as shown.

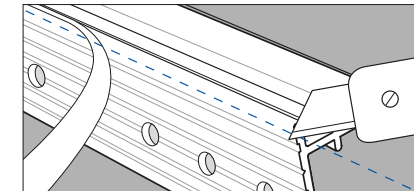

Four

Wipe the shower tray/bath ledge with the cleaning wipes provided. Insert the Sureseal strip upside down into the mitre box for support. Apply a thick line of Showerwall sealant along the full length of the trim.

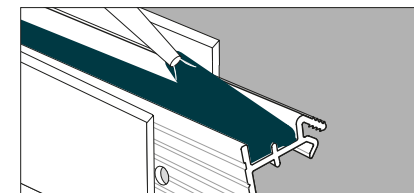

Five

Spread the Showerwall sealant into the Sureseal strip with the sealant profiler provided as shown. Redistribute or add sealant if required. Ensure that the sealant is flush with ends of the strip.

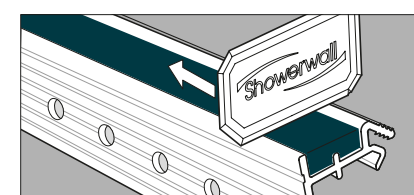

Six

With a finger under the Showerwall

sealant nozzle and a fingertip against the wall as guide, lay a straight continuous and generous bead of sealant on the shower tray / bath ledge just inside the pencil marks which

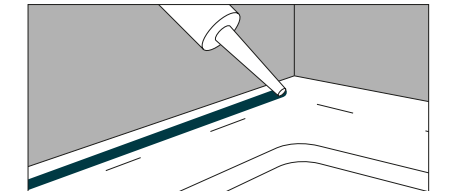

indicate the outer edge of the strip.

Seven

Place the first Sureseal strip into position fusing the Showerwall sealant in the strip with the sealant on the shower tray/bath ledge. Check the strip is sitting level using a spirit level. Nail/screw the trim to the wall/battens and remove any excess sealant. Repeat this process for the second Sureseal strip. Seal the mitre joints to ensure full fusion of

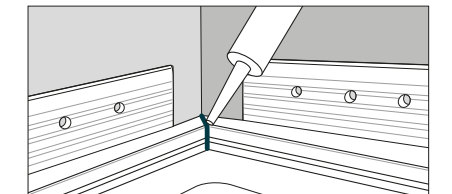

sealant at the joint.

Eight

Insert the Sureseal end caps* into the exposed end of the Sureseal strip. Ensure that the end cap tabs are seated into the Showerwall sealant.

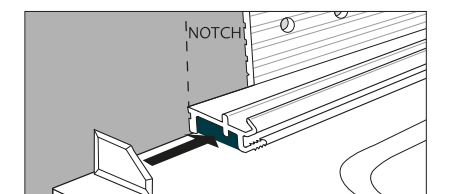

SQUARE EDGE PANELS

Section Three

TWO SIDED SHOWER STEPS

One

Apply continuous beads of Showerwall panel adhesive to the full length of the reverse of the internal corner trim. Fix the internal corner trim into position ensuring it is plumb using a spirit level and sitting on the flexible nib of the Sureseal base trim.

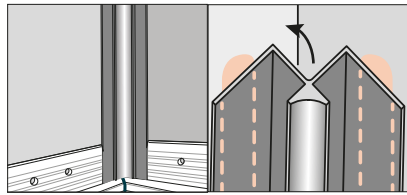

Two

Apply Showerwall sealant into the left hand channel recess of the internal corner trim in sufficient quantities to ensure the sealant fully envelopes the edges of the panel when inserted.

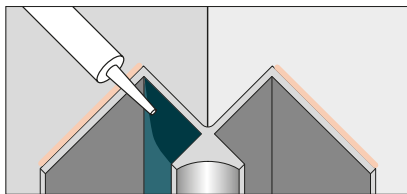

Three

Prior to installing the previously measured and cut panel, wipe all panel edges with the surface cleaning tissue supplied. Place a generous bead of Showerwall sealant into the recess of an end trim profile and locate the trim onto the left hand edge of the panel.

Ensure the sealant fully envelopes the edge of the panel when inserted.

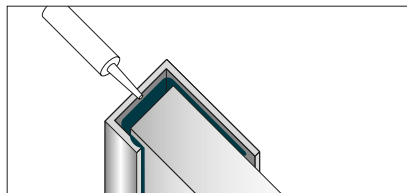

Four

Where Sureseal strip is used: apply a continuous line of Showerwall sealant into the Sureseal strip, filling it completely to the height of the channel.

Where sureseal strip is not used: place small width 3mm high spacers close to the back edge of the shower tray / bath ledge to support the panel and create a 3mm clear gap at the panel base when fitted. To be filled with Showerwall sealant as per step 8.

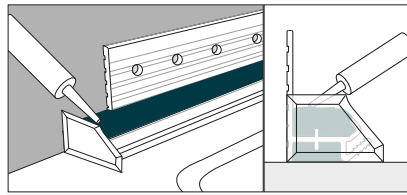

Five

Apply a minimum 6mm thick bead of Showerwall panel adhesive in a snake like line to the wall at the top, middle and bottom points of where the panel will be fixed. Apply further adhesive equally between these points until a full tube of adhesive has been used.

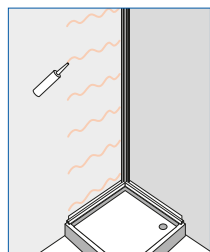

NOTE: When fixing to tiles conduct the same adhesive application method in conjunction with using Showerwall sealant as the fixing adhesive. Use one sealant tube to fix each panel.

Six

Position the panel on the Sureseal strip or 3mm spacers, slide the exposed panel edge into the previously installed internal corner trim ensuring the panel is firmly pushed into the trim recess and the sealant fully envelopes the panel.

Excessive sealant should ooze between flexible nib of the Sureseal base trim and the front face of the panel, fully enveloping the bottom edge.

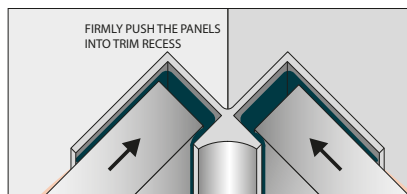

NOTE: Apply even pressure across the panel face to ensure sound contact of the adhesive to the reverse of the panel. Repeat for each panel.

Seven

Install your second panel by repeating steps 2-5 above.

Eight

Run the Sealant Profiler (found with the Sureseal end caps) across the unbroken sealant line to ensure excess sealant is flush and consistent. Reapply and re-profile where necessary.

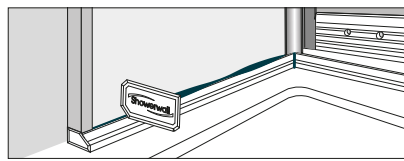

Nine

Locate the face capping onto the Sureseal base trim fully by applying even pressure along its length. Audible 'clicks' will be heard as the capping clicks into place. Ensure that the top flexible capping seal is in contact with the entire length of the panel surface.

NOTE: Check the mitre joint ends align correctly. Minor trimming or adjustment of the mitred ends of the capping may be necessary. Fill any gaps at the mitre joint with sealant.

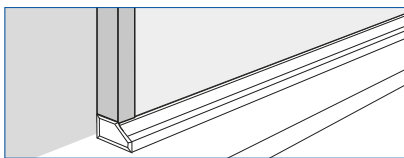

Ten

Complete the top panel edge detailing by filling the 3mm gap between the top edge of the panel and ceiling with Showerwall Sealant.

Eleven

Allow the adhesive and sealant to fully cure for 24 hours. After installation of your chosen shower cubicle clean your Showerwall panels with the Showerwall Supercleaner.

SQUARE EDGE PANELS

Section Four

THREE SIDED SHOWER STEPS

One

Install Sureseal strip sections using the procedures detailed in Section 2.

NOTE: A three sided installation requires 3 sections of Sureseal strip and 2 mitre joints.

Two

Install left hand internal corner trim as detailed in step 1 of Section 3.

Three

Install the left hand Showerwall panel as detailed in step 2-6 of Section 3.

Four

Measure and cut the centre panel to size, allowing for the additional right hand internal corner trim to be used.

Five

Apply sealant into the right hand recess of the installed internal corner trim.

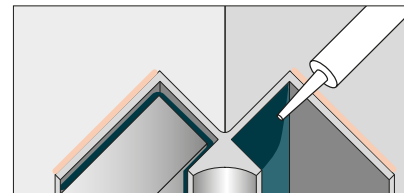

Six

Apply Showerwall sealant into the left hand recess of the second internal corner trim in sufficient quantity to ensure the sealant will fully envelope the edge of the panel. Firmly locate the trim onto the right hand panel edge of the centre panel.

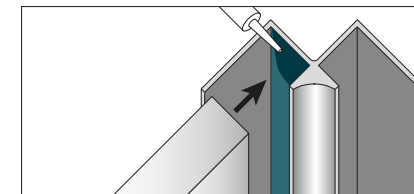

Seven

Repeat Steps 4-5 of Section 3 for adhesive wall and sealant application method. Showerwall adhesive should now be applied to the back edges of the right hand internal corner trim being installed.

NOTE: Attach suction grips to the face of the panel to make handling this panel easier.

Eight

Locate the bottom edge of the left hand panel onto the Sureseal strip or spacers.

Locate the left hand panel side edge into the right hand recess of the previously fitted internal corner, rotating the right hand side of the panel into position firmly pushing the panel and corner trim onto the adhesive.

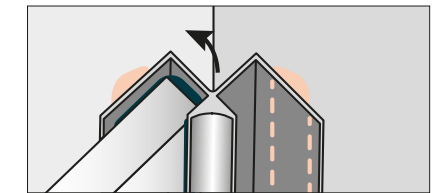
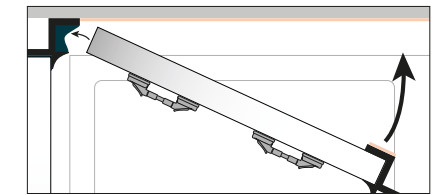

continued...



SQUARE EDGE PANELS

Section Four

Nine

Repeat Steps 2-6 from Section 3 for the fitting of the final right hand panel.

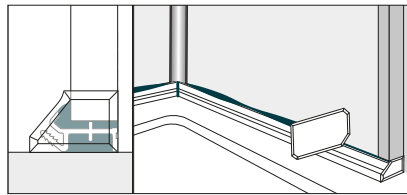
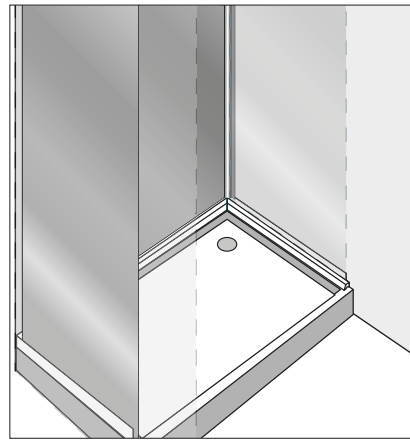

Eleven

Locate the face capping fully by applying even pressure along its length. Audible 'clicks' will be heard as the capping clicks into place. Ensure that the top flexible capping seal is in contact with the panel surface along its entire length.

Ten

Using the Showerwall Sealant Profiler (found with the Sureseal end caps) run the profiler across the unbroken sealant line ensuring the excess sealant is left flush and consistent. Reapply and re-profile where necessary.

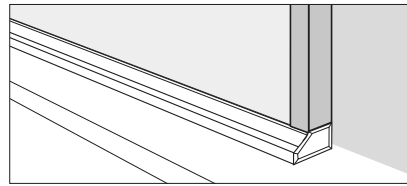

NOTE: Check the mite joint ends align correctly. Minor trimming or adjustment of the mitred ends of the capping may be necessary. Fill any gaps at the mitre joint with sealant.

Twelve

Complete the top panel edge detailing by filling the 3mm gap between the top edge of the panel and ceiling with Showerwall Sealant.

Thirteen

Allow the adhesive and sealant to fully cure for 24 hours. After installation clean your Showerwall panels using Showerwall Superclean cleaner.

SEALING PIPES, HOLES & CUT OUTS

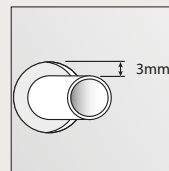

When cutting out or drilling holes into your panels to accommodate pipes or shower units, ensure a clearance space of 3mm width is left between the fixed object being cut around and the panel edge.

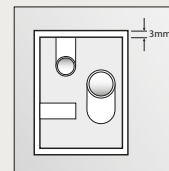

The 3mm clearance space must then be fully filled with Showerwall sealant once the panels are installed and before any fittings or shower units are fitted.

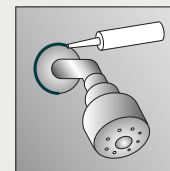
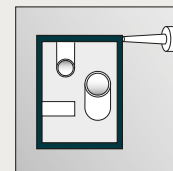
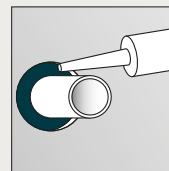

Following the fitting of any shower units or pipe collars etc. always seal the shower unit casing or pipe collars again to ensure a further watertight seal exists externally around the unit / collars.

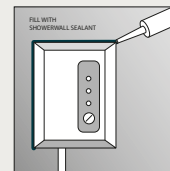

Note: Failure to adequately seal any cut edge sections of the panel may result in the panel edges swelling and will invalidate your product guarantee.

PROCLICK PANELS

Section Five

PLANNING CONSIDERATIONS

ProClick panels can be used to line out full rooms or multiple walls within a room.

Always start from a corner and work out in both directions to finish the installation by cutting and fixing the final square cut panel over the doorway.

Where possible, centralise the panel runs to avoid having narrow strips at the corner profile points. Avoid positioning panel joints where they could be exposed to constant running water from shower heads etc.

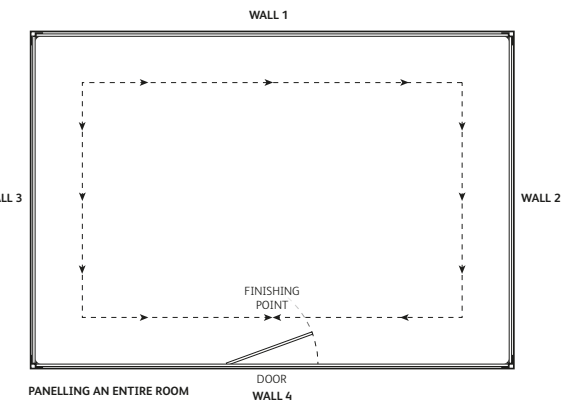
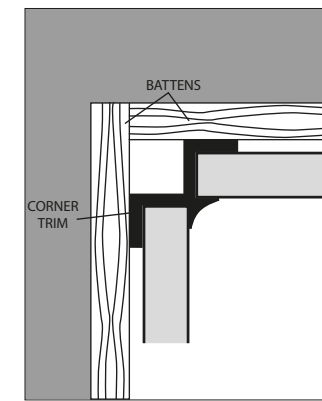

FIXING TIMBER BATTENS

If the walls are uneven or out of plumb, fix ProClick panels on to vertical and horizontal battens and not directly to the wall.

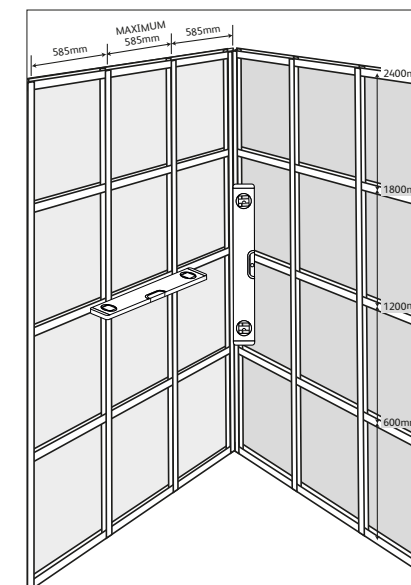

NOTE: Fitting panels directly to uneven walls will effect the quality of the panel joints and may result in the adhesive not making contact with the panel surface when installed.

Where the walls are not suitably plumb and flat ProClick panels must be fixed to a timber batten frame system using either Showerwall adhesive or screw fixings at 600mm centres using the correct size screws detailed above, to provide a level and plumb surface to ensure an asymmetrical panel joint is achieved.

Uniform thickness timber battens approximately 25mm x 50mm should be fixed vertically at 585mm centres where 585mm panels are used.

Ensure all vertical panel joints are supported appropriately by vertical battens, the spacing of which should be determined to suit your particular panel face width being installed.

All battens must be installed plumb and parallel and packing spacers used to ensure all battens are fully plumb and their surface faces are level.

Additional battens should be positioned to carry heavy items such as hand basins, wall mounted toilets or furniture. Vertical battens should also be present in the corners to support the corner profiles.

RECOMMENDED FIXINGS

Flat Head
Countersunk Screw
18mm (¾") x No. 6

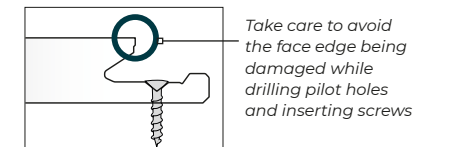

PANEL BASE & FLOOR DETAIL

Use either Sureseal strip (installed as previously detailed in Section 2) or 3mm spacers to leave a 3mm gap at the bottom panel edge which will be filled with Showerwall sealant.

Ensure the Sureseal strip is installed level using a spirit level.

Where a 3mm gap is to be left ensure your floor and spacers are also level.

NOTE: If your bottom support is not level it will affect the vertical panel joints and top panel edge of the installed panels. **Pattern match is not guaranteed.**

Section Five

INSTALLATION STEPS

One

Apply continuous beads of Showerwall panel adhesive to the full length of the reverse of the internal corner trim.

Fix the Showerwall internal corner trim in position ensuring that it is plumb using a spirit level.

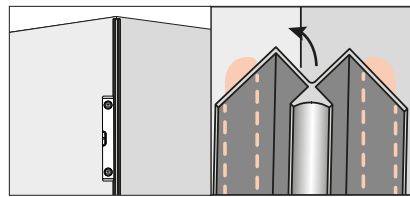

Two

Cut the ProClick tongue profile off your first panel, leaving a square cut edge.

NOTE: Repeat this at each corner starting point.

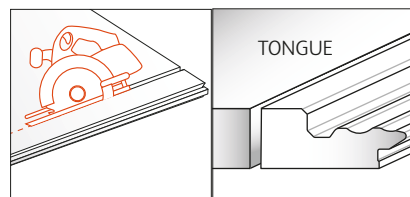

Three

Apply Showerwall sealant into the right hand channel recess of the internal corner trim and bottom Sureseal trim if used in sufficient quantities to ensure the sealant fully envelopes the edges of the panel when installed.

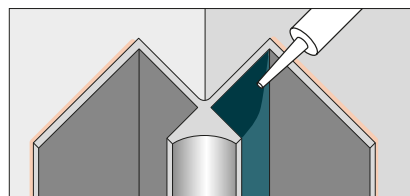

Four

Apply a minimum 6mm bead of Showerwall panel adhesive in a snake like pattern to the walls that your panel will be fixed to.

If the Sureseal strip is being used, fill the channel of the strip with sealant as detailed previously in Section 3.

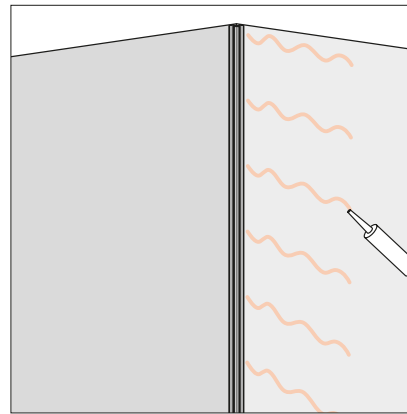

Five

Wipe all edges with the surface cleaning tissue.

Fix suction grips to the face of the first panel to aid lifting and handling and lift and locate the panel bottom edge onto the Sureseal strip or 3mm spacers and slide the square cut panel edge into the previously installed corner trim ensuring the panel is firmly pushed into the trim recess and that the sealant fully envelopes the panel edge.

NOTE: Apply even pressure across the panel face to ensure sound contact of the adhesive to the reverse of the panels. Repeat for each panel.

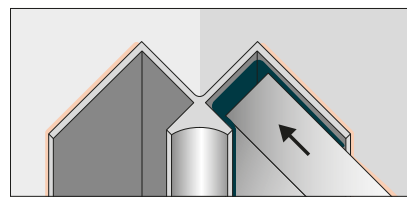
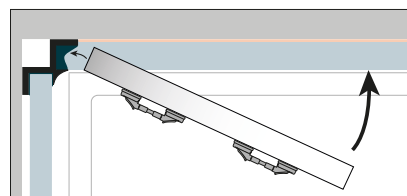

Six

Repeat the same adhesive application procedure for the next section of wall step 4.

Using an uncut sealant nozzle, apply a small, continuous full length bead of sealant to the shoulder of the ProClick tongue profile of the next panel.

NOTE: Avoid putting too large a bead of sealant on the profile as too much can prevent the joint locating together correctly.

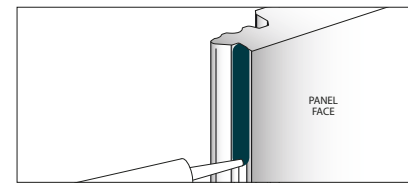

NOTE: A small visible dark line at the joint is not deemed as a product defect should it be present once the panels have been installed.

Seven

Lift and locate the panel bottom edge at an angle onto the Sureseal strip or 3mm spacers and locate the tongue of the panel into the groove of the previously installed panel, ensuring the panel is fully located onto the Sureseal channel with the panel top edges flush and evenly squeezing out the Showerwall sealant and locking the joint. Rotate the panel onto the wall

Ensure the front flexible nib (A) of the Sureseal trim springs up the front bottom edge of the panel after the panel is fully fitted to the wall.

NOTE: Apply even pressure across the panel face to ensure sound contact of the adhesive on the reverse of the panels.

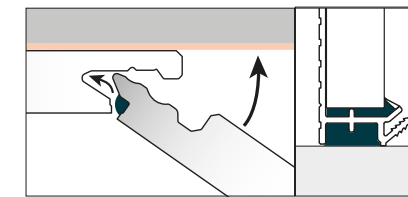

Section Five

Eight

Immediately after assembling each joint, clean off any sealant overspill from the joint/panel face.

NOTE: A small visible dark line at the joint is not deemed as a product defect should it be present. Pattern match is not guaranteed.

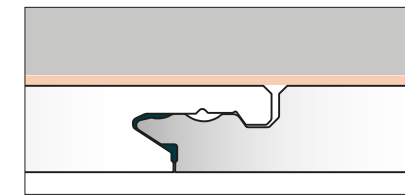

Nine

Repeat steps 6-7 for the following panels. Ensure to check each panel once installed to ensure that all of the panel edges are plumb and level using a spirit level.

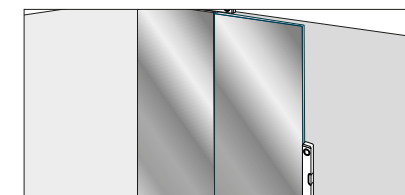

Ten

Measure and cut the final panel to width removing the groove side as necessary, ensuring the width measurement accommodates the internal corner trim width as advised in Section 1.

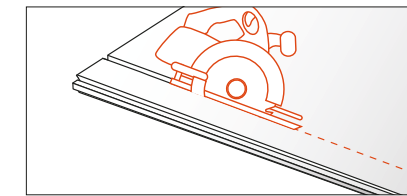

Eleven

Generously apply sealant into the left hand recess of the internal corner trim, ensuring the sealant fully envelopes the edge of the panel. Firmly locate the trim onto the square cut panel edge.

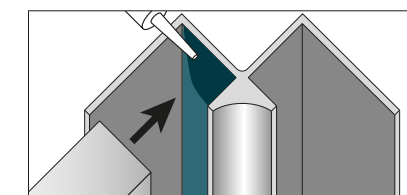

Twelve

Repeat steps 4, 6 and 7. Locate the ProClick profile of the panel edge into the groove of the previous fitted panel. Firmly push the panel and corner trim onto the adhesive beads, into position.

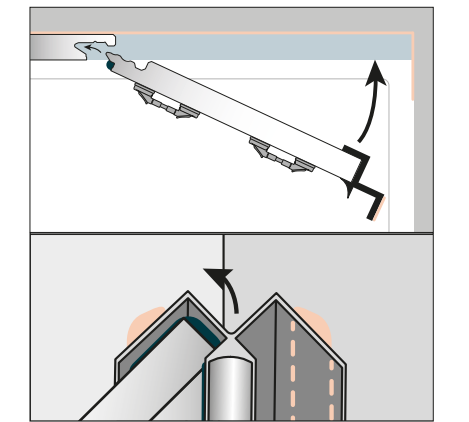

Section Five

Thirteen

Apply continuous beads of Showerwall panel adhesive to the full length of the reverse of the internal corner trim.

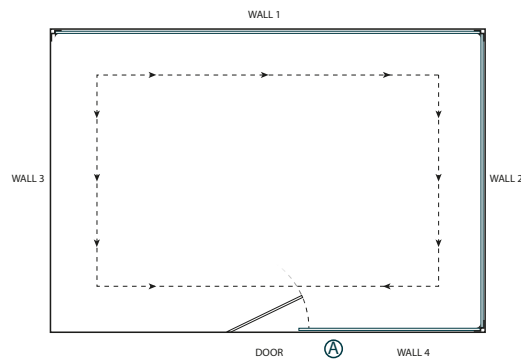
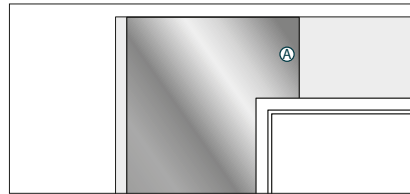

NOTE: Prior to installing your final panel cut off the projecting element of the groove profile level with the face of the panel leaving the internal edge section of groove intact in preparation for the final sealant application.

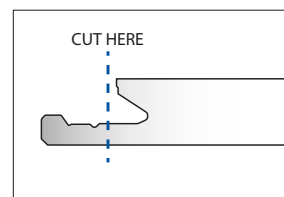

Fourteen

Repeat the procedures used for wall 1 & 2 to complete walls 3 and the second section of wall 4 to the doorway point (B) leaving sufficient space for the final panel above the door.

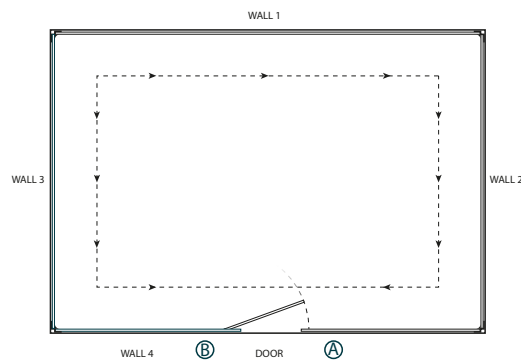
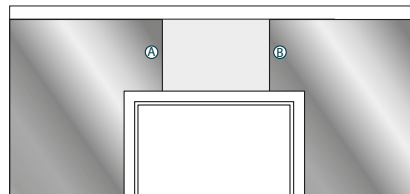

Fifteen

Measure and cut the height of the final panel above the door.

Sixteen

Measure and cut the width of the panel removing the right hand groove side of it. Ensure a clean straight cut is achieved.

Once cut, dry fit the panel to ensure an accurate fit. Remove the panel in preparation for panel fixing with suction grips.

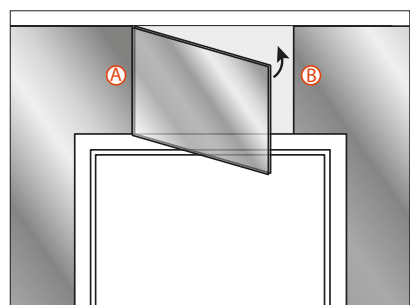

Seventeen

Apply Showerwall adhesive in a snake like pattern to the wall.

Apply Showerwall sealant to the left hand ProClick profile of the panel as per step 6.

Apply a bead of Showerwall sealant into the groove of the previously installed right hand panel ensuring the sealant exceeds the edge of the panel, as shown above.

Locate the ProClick profile into the groove of the left hand panel (A) and rotate the final panel into position ensuring the panels are flush across the right hand joint (B).

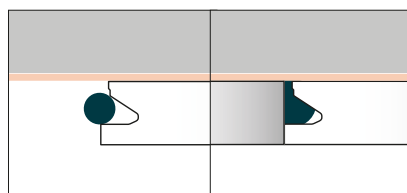

Eighteen

Immediately after assembling each joint, clean off any sealant overspill from the joint/ panel face.

Nineteen

Seal the top and bottom of the installation as advised in Section 3.

Twenty

Allow the adhesive and sealant to fully cure for 24 hours. After installation of your chosen shower cubicle clean your Showerwall panels using Showerwall Superclean cleaner.

NOTE: A small visible dark line at the joint is not deemed as a product defect should it be present. Pattern match is not guaranteed.

Section Five

JOINING TRIMS

When using multiple square edge Showerwall panels in conjunction with Joining trims (D) and Sureseal strip (F).

The Sureseal strip must be notched (cut out) to accommodate the Joining trim back plate. For trim dimensions please see components available in Section 1.

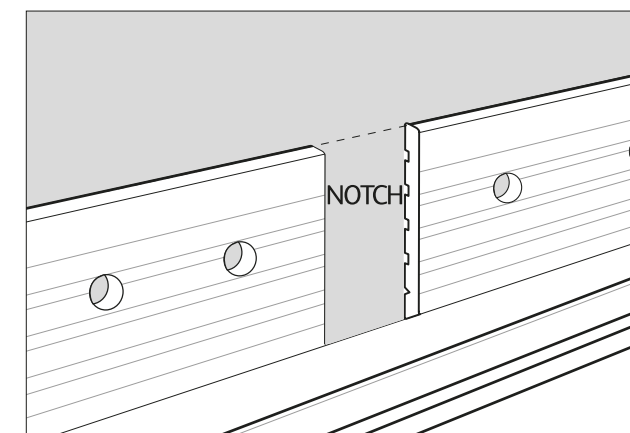

Secure the joining trim using adhesive as previously stated for all Showerwall trims. Ensure all the trim recess' are filled with sealant prior to installing the panelling. Ensure the sealant fully envelopes the edge of the panel when inserted.

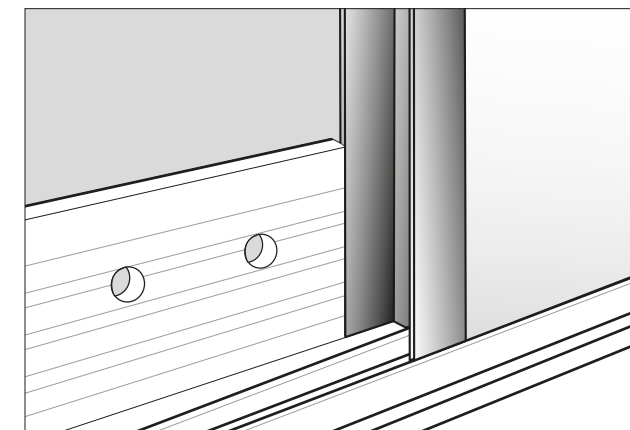

EXTERNAL CORNERS

Where panels are being used to cover a 90° wall return or pipe box section use an external and internal corner trims.

It may be necessary that the external trim and cut panels are fabricated as one unit and fixed into the previously installed internal corner trims to complete the install.

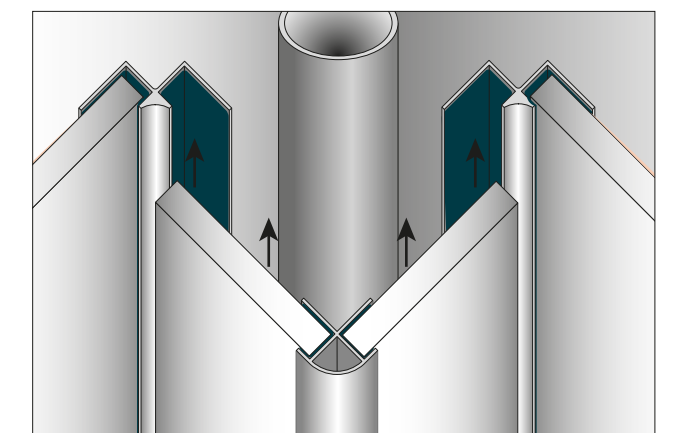

Ensure all trims are fixed with Showerwall adhesive and the trim recess' are filled with Showerwall sealant prior to installing the panel sections.

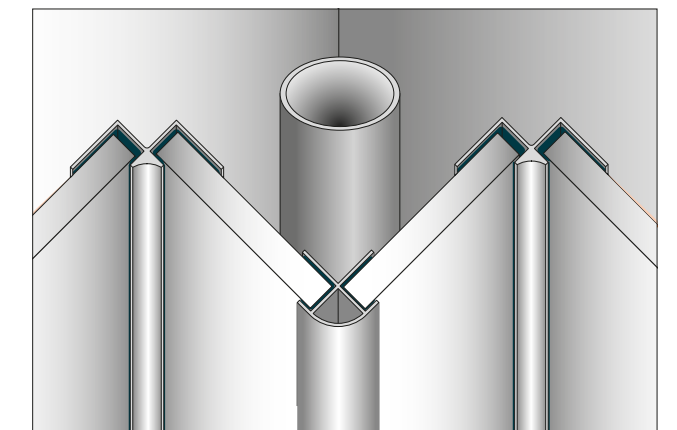

Section Five

WINDOW REVEALS

Use the Showerwall external trim for each external corner point around your window reveal.

NOTE: A mitre box is required for this element of installation. This is supplied in the Showerwall Components Kit (if purchased).

Ensure all trims are fixed with Showerwall adhesive and all trim recess are filled with Showerwall sealant prior to installing the panel sections.

Measure and cut the final panel sections ready for installation. Dry fit each section to ensure correct angles, sizes and a neat fit.

Measure and compound mitre cut each section of external corner trim as required. Ensure the trim is placed in the mitre box correctly so that the correct compound angle is achieved.

Once the trims have been correctly mitre cut to length and checked for accurate fitting, fix the trims in place using Showerwall adhesive in the same manner previously detailed.

Next, apply Showerwall adhesive to the window reveal wall sections in the same manner as detailed in step 4 of section 3.

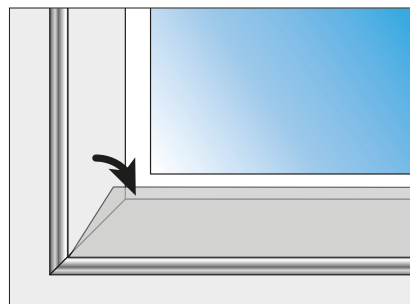
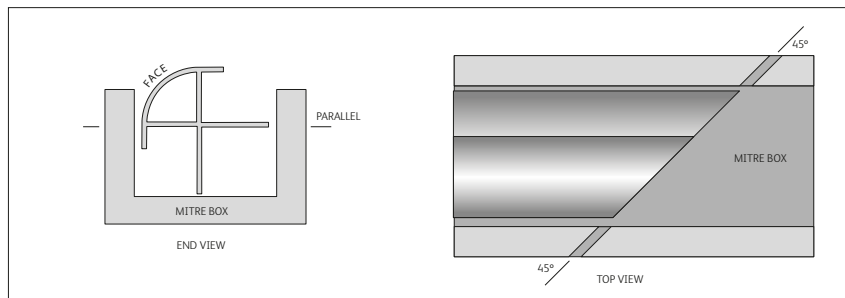
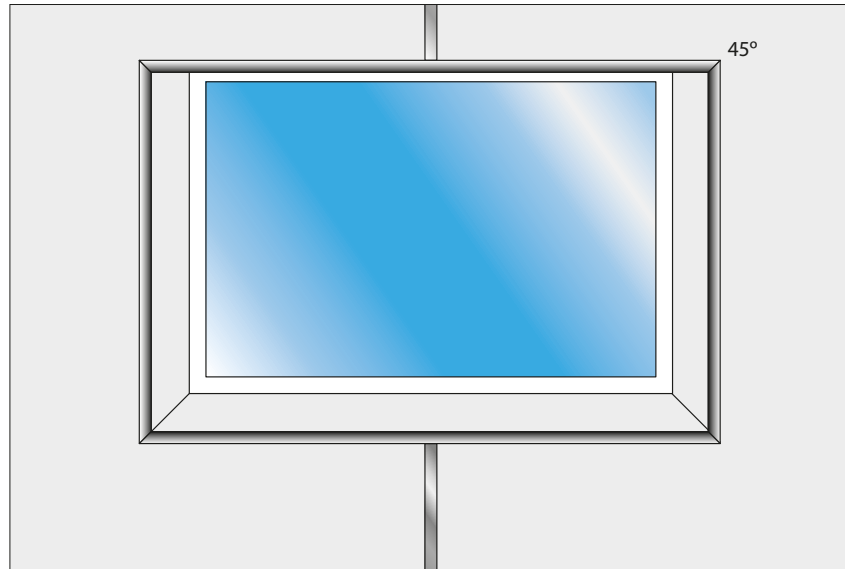

Install the two horizontal (top and bottom) sections first by inserting the panel into the trim recess at an angle ensuring that it is then fully pushed onto the adhesive.

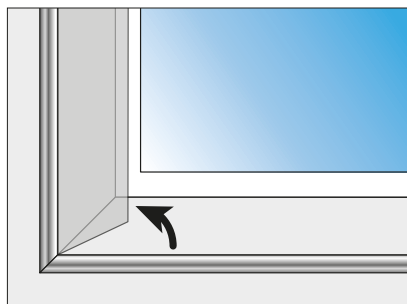

Proceed on installing the two vertical (sides) sections using the same method.

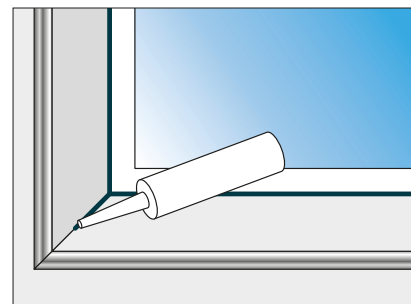

Complete the installation by applying Showerwall sealant across the top and bottom corner (joints and rear) edges that meet the window frame.

Section Five

FLEXIBLE FLOORCOVERING INSTALLATION

Measure and cut a 9mm thick MDF / Plywood packer / upstand which will be fixed at the wall base and below the Showerwall panelling.

Ensure that the packer is perfectly level across its top edge before securing it into position with appropriate length screws.

The height of the packer should reflect the desired height / upstand section of the flexible floorcovering to be installed.

Apply an ample bead of Showerwall sealant across the top edge of the previously installed packer for the Sureseal strip to locate onto (A). Locate the Sureseal strip onto the top of the packer and firmly press into the Sureseal sealant. Check the Sureseal strip is sitting level using a spirit level.

Nail/screw the Sureseal strip to the wall and remove any excess Showerwall sealant (B).

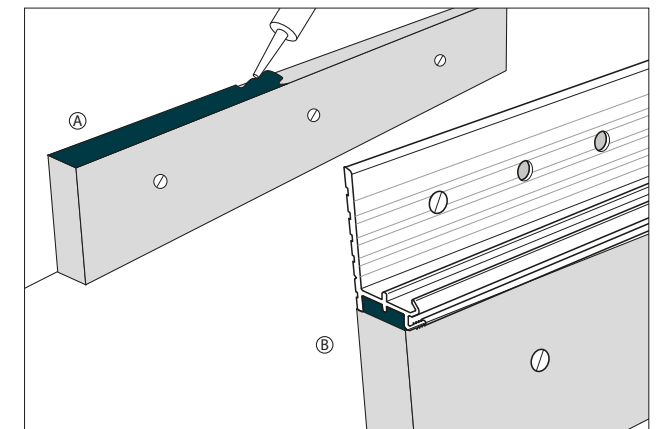
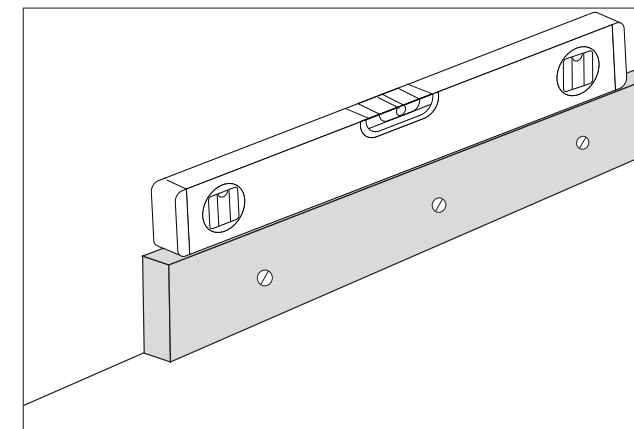

Using the Showerwall Sealant Profiler (found with the Sureseal end caps) run the profiler across the unbroken sealant line ensuring the excess sealant is left flush and consistent. Reapply and re-profile where necessary.

Proceed fitting the Showerwall panels in accordance with the relevant previous sections. Install the floorcovering ensuring that the edge of it laps up the face of the packer section and under the bottom edge of the Sureseal strip.

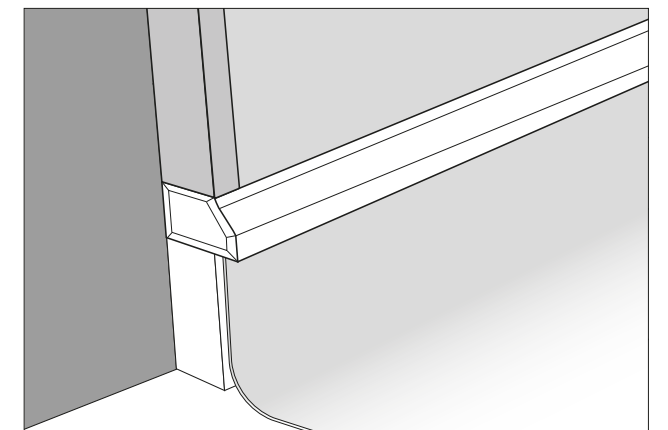
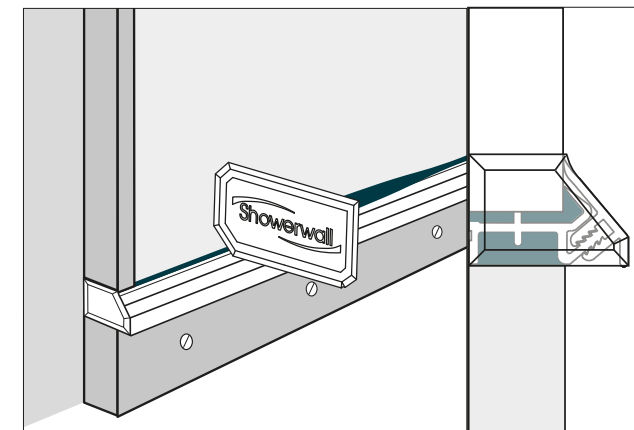

CARE, MAINTENANCE & GUARANTEE DETAILS

Section Six

CARE

The non-porous surface of Showerwall provides excellent protection against bacteria and is easily cleaned and maintained.

Showerwall Superclean is a non-abrasive, pH neutral cleaner specifically formulated and tested for use with your Showerwall panels and will achieve a streak free finish on Showerwall, Glass, Sanitaryware, Taps & Plastics.

It kills bacteria viruses, mould and has a sterilising affect on your Shower area keeping the surfaces clean without scratching and is recommended for the optimum life and performance of your Showerwall panel system.

Your Showerwall panels should be rinsed down after each use of your shower and cleaned using Showerwall Superclean. Not rinsing away chemicals such as hair dyes or hair bleaches may have a discolouring affect on the Showerwall sealants.

MAINTENANCE

Any exposed bottom edge sealants may need to be replaced periodically, and or as necessary dependant up on shower usage and normal sealant degrade, and is a normal good maintenance procedure. Failure to maintain exposed sealants as necessary may result in water ingress into the panel core and subsequent panel damage and will invalidate your guarantee.

Any exposed bottom edge sealant beads can be replaced using the Showerwall silicone eater accessory, which assists in the easy removal of your old sealant beads prior to resealing with new Showerwall sealant.

Showerwall Silicone Eater is available via your Showerwall supplier.

NOTE: Abrasive cleaners or bleaches must not be used on the panelling.

Please ensure the property owner retains this section for future reference.

GUARANTEE

Showerwall panels will be free from defects caused as a direct result of faulty manufacture for the period of thirty (30) years in the case of panels installed in a domestic environment, and five (5) years in the case of panels installed in a commercial environment.

Note the 30 year term of the guarantee for panels installed in a domestic environment is only applicable when the purchase of the panels has been registered within 28 days of the installation of such panels. In the event that the purchase of the panels is not registered within the 28 Days, the Guarantee Period for panels that have been installed in a domestic environment will be fifteen (15) years from the date of invoice.

Registration of the purchase of the panels can be made online via www.showerwall.co.uk or by returning the registration document contained within the product packaging.

This guarantee is only valid and applicable where the Showerwall system installation is fully in accordance with these set of instructions. No guarantee is offered where the installation is not in accordance with these instructions or is a unique or bespoke form of installation. Please contact Showerwall if any queries exist in relation to your particular installation.

A copy of the complete guarantee document is available upon request or can be downloaded at www.showerwall.co.uk.

INSTALLATION DATE	PANEL BATCH NO.
INSTALLER DETAILS	





**Naturally inspired
surfaces**

T: 0845 604 7334

E: info@showerswall.co.uk

www.showerswall.co.uk | 2022-V1