

Salamander Pumped Shower Systems Limited  
Unit 2c Colima Avenue, Sunderland, SR5 3XE  
Tel: 0191 516 2002  
Fax: 0191 548 4445  
Email: [service@salamanderpumps.co.uk](mailto:service@salamanderpumps.co.uk)

---

the 1990s, the number of people in the UK who are employed in the public sector has increased from 10.5 million to 12.5 million (12.5% of the population).

There are a number of reasons why the public sector has grown so rapidly. One of the main reasons is that the government has been spending more on public services. This has led to an increase in the number of people employed in the public sector. Another reason is that the private sector has been unable to provide enough services to meet the needs of the population. This has led to the government stepping in to provide these services.

The growth of the public sector has led to a number of problems. One of the main problems is that the government has to spend more on public services. This has led to an increase in the national debt. Another problem is that the public sector has become more bureaucratic. This has led to a decrease in efficiency and an increase in costs.

There are a number of ways in which the public sector can be reformed. One way is to reduce the number of people employed in the public sector. This can be done by privatizing some of the public services. Another way is to improve the efficiency of the public sector. This can be done by introducing competition and by reducing bureaucracy.

The public sector is a complex and controversial issue. There are a number of different views on how it should be reformed. However, it is clear that the public sector has grown too large and is too inefficient. It is time to consider ways in which it can be reformed to better serve the needs of the population.

## References

- Adams, J. (1997) *The Economics of the Public Sector*. London: Macmillan.
- Barro, R. J. (1996) *Government Spending in the United States*. Cambridge, MA: MIT Press.
- Baumol, W. B. (1985) *The Growth of Government*. Cambridge, MA: MIT Press.
- Baumol, W. B. (1990) *The Growth of Government*. Cambridge, MA: MIT Press.
- Baumol, W. B. (1992) *The Growth of Government*. Cambridge, MA: MIT Press.
- Baumol, W. B. (1994) *The Growth of Government*. Cambridge, MA: MIT Press.
- Baumol, W. B. (1996) *The Growth of Government*. Cambridge, MA: MIT Press.
- Baumol, W. B. (1998) *The Growth of Government*. Cambridge, MA: MIT Press.
- Baumol, W. B. (2000) *The Growth of Government*. Cambridge, MA: MIT Press.
- Baumol, W. B. (2002) *The Growth of Government*. Cambridge, MA: MIT Press.
- Baumol, W. B. (2004) *The Growth of Government*. Cambridge, MA: MIT Press.

## Appendix

The following table shows the number of people employed in the public sector in the UK from 1990 to 2000. The number of people employed in the public sector has increased from 10.5 million in 1990 to 12.5 million in 2000.

Year	Number of people employed in the public sector (in millions)
1990	10.5
1991	10.6
1992	10.7
1993	10.8
1994	10.9
1995	11.0
1996	11.1
1997	11.2
1998	11.3
1999	11.4
2000	12.5

# Pump installation and warranty guide for Right Pumps

## Important – read this first!

- Correct installation is the guarantee of safety and a trouble free system. It is therefore important to read these instructions thoroughly and ensure you comply with them. Incorrect fitting can invalidate the warranty.

Pages 10 to 11 of this manual provide clarification of some of the more unusual installation requirements. If your installation is complicated or you have any questions please CONSULT THE PUMPWISE HELPLINE IMMEDIATELY.

We encourage installers to consult the PumpWise helpline, where our engineers can give you first-rate advice regarding installation. Consulting the helpline at the time of installation could entitle your customer an additional year's warranty FREE (UK only) – all you have to do is call us, implement our engineers recommendation for your installation situation, then ask your customer to register.

When the job is finished – tear off the final page of this instruction manual and hand it to the householder. This page explains the warranty provisions and provides a pre-paid warranty card.

Don't forget that if you have called our helpline you should also complete the comments section of the card to say how you rate the service you received.

Please leave this installation guide with the customer for reference to maintenance and safety information.

Thank you for choosing  
Salamander Pumps

# Contents

Pre-installation checklist	2
Typical installations	
Right positive pumps	6
Right universal pumps	
System operation and L.E.D. indication	7
Typical installations	
Right universal pumps	9
Commissioning	11
Helpful PumpWise guidelines	12
Cold water supplies and storage	
Helpful PumpWise guidelines	14
Water starvation protection, pipework arrangements and stored hot water	
General specifications	18
Trouble shooting	21
PumpWise and warranty	23
To the installer	24

# Pre-installation checklist

**Our pre-installation guidelines are detailed on the following pages, but some of the key “do’s and don’ts” are highlighted below:**

## Do’s

- Locate the pump next to the hot water cylinder OR no further than 4m away in 22mm pipe work
- Allow 100mm on all sides for ventilation
- Ensure pump is protected from frost
- If servicing two or more bathrooms, cold water supply to the cylinder must be in 28mm pipe work
- Ensure adequate cold water storage (50 gallons/bathroom, 80 gallons for one bathroom and one en-suite)
- Cold water supplies to the pump must be taken from the opposite side of the cold water storage tank to the cold water mains inlet
- Multiple cold water storage tanks must be linked in 28mm pipe work and the bottom of the tanks must be at the same level
- Hot water supply to the pump must be via a Salamander approved flange
- AV couplers must only be finger tight plus one quarter turn
- The maximum static head should be 10m (equivalent to 100kPa/1.0 bar pressure) – only exception is the RP50TU which is 5m (equivalent to 50kPa/0.5 bar pressure)
- We recommend the pump is activated for at least 5 minutes every 4 weeks

## Don’ts

- Never fit the pump to the cold water mains
- Never fit the pump to communal risers
- Never use a shared water supply
- Never put a non-return valve (NRV), inverted loop, restrictive balofix or an air vent on supply pipe work to the pump
- The hot water supply to the pump must not exceed 60°C
- Never twist the anti-vibration (AV) couplers or bend more than 35°
- Never use mechanical tools to tighten coupler nuts as this may cause damage and will invalidate your warranty
- Never use jointing compounds, Boss White, Hemp or steel wool
- Solder fluxes must not come into contact with the pump or AV couplers
- Never install in a bathroom unless in an enclosed space and access is only possible with an appropriate tool
- Never pump directly to or from another pump
- Never connect to a secondary return tapping on a hot water cylinder

## BEFORE INSTALLATION OF YOUR NEGATIVE HEAD PUMP:

Please fit the pressure vessel if packaged separate to the pump. Use the ½ “ flat rubber washer in the ½ “ brass connection on the top of the pump junction box. Screw the pressure vessel into the connection hand tight.

**Please follow these installation instructions carefully. Failure to install your pump in accordance with these instructions will invalidate your warranty.**

## 1. Location of the pump

The best possible location for the pump is at or near the base of the cylinder at least 600mm below the bottom of the cold water storage tank. Where it is not physically possible to locate the pump next to the cylinder, the pipe run from the hot water cylinder to the pump must not exceed 4m in 22mm pipe work.

### 1.1 Cooling and ventilation

The pump should be placed in a position where there is an adequate air flow to cool the motor and separated from any other appliances that generate heat. It should be installed in a clear space allowing 100mm additional space at each side, the ends and top of the pump.

### 1.2 Frost protection

Loft mounted pumps must be protected from frost damage.

## 2. Hot and cold supplies to the pump

Never fit the pump directly to the cold water mains.

Never fit to communal risers (e.g. block of flats) or secondary circuits that are pumped.

The pump must be fed by exclusive hot and cold water supplies (i.e. not shared with other services) and in 22mm pipe work (Note: for the RP50PT and RP50PS a maximum of 2m of 15mm inlet pipework direct from the cylinder to the pump).

The hot supply pipe work should be a maximum of 4m from the cylinder in 22mm pipe work.

All up and over pipe work must be vented at

the highest point on the outlet of the pump and a non-return valve (NRV) may require fitting to the hot outlet only (Note: this is only for the RP50TU and RP55SU).

### 2.1 For pumps positioned above the hot outlet, hot water cylinder or in a loft

An anti-gravity loop (AGL) off a No stop Essex Flange must be used when it is sited above the dome of the hot water cylinder as it prevents air tracking up into the pump chamber and back siphoning of the water again, creating air in the pump chamber.

Never put a non-return valve, inverted loop, restrictive balofix or an air vent on the supply pipe work to a pump.

Where the pump is servicing two or more bathrooms, the cold water supply to the cylinder must be in 28mm pipe work.

### 2.2 Cold water storage

Ensure that the cold water storage capacity is adequate for all of the household requirements (minimum 50 gallons/227 Litres per bathroom, 80 gallons/385 Litres for one bathroom and one en-suite shower room).

Ensure the cold water supplies to the cylinder and the pump are taken from the opposite side of the cold water storage tank from the cold mains inlet.

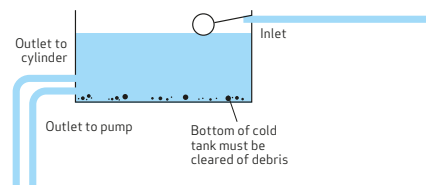

**Figure 1: Tank inlet and outlet position**

Multiple cold water storage tanks **MUST** be linked in 28mm pipe work with the bottoms of the tanks at the same level.

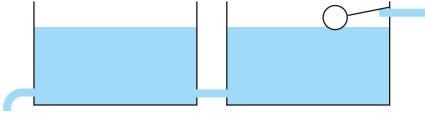

**Figure 2: Linked cold water tanks**

### 2.3 Hot water requirements

The stored hot water temperature must not exceed 60°C (see page 17, Stored hot water temperature).

The hot water supply to the pump must be via a Salamander approved method:

The best hot connection from the cylinder is either

- A 3/4" NO STOP ESSEX FLANGE. See Figure 3 or
- Alternatively a Salamander S flange or other approved top entry flanges. See page 15/16.
- Never fit to top entry flange if the pump is fitted above the cylinder.

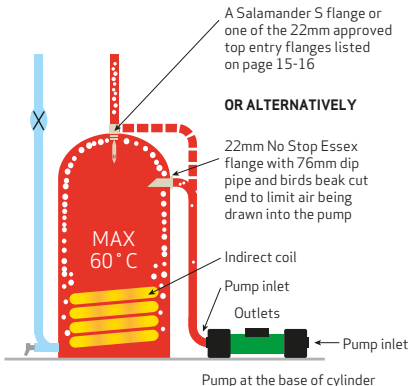

**Figure 3: Hot water supply method**

### 3. Anti-vibration couplers (Hoses)

The anti-vibration (AV) couplers are designed to limit the transfer of pump vibration to the associated pipe work. All Salamander AV couplers are 3/4" BSP x 22mm push fit with built-in isolating valves. Note: the RP50PT and RP50PS are supplied with 15mm couplers with isolating valves

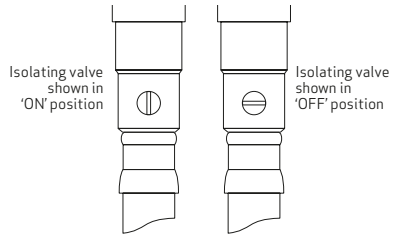

on the inlets and outlets.

**Figure 4: Isolating valves**

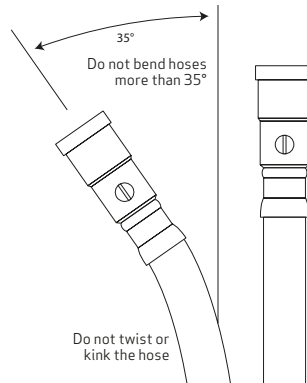

**Figure 5: Couplers**

Ideally the AV couplers should be straight,

but they must NOT be twisted or bent more than 35° (this invalidates the warranty). See Figure 5 above.

Each single pump is supplied with two couplers; one angled and one straight. The angled coupler should be attached to the pump inlet (on the side) and the straight coupler should be attached to the pump outlet (on the top).

Each twin pump is supplied with four couplers; two angled and two straight.

For all pumps, the inlets are on the side of the pump and the outlets are on the top of the pump.

The AV couplers MUST only be tightened to finger tight plus one quarter turn. Mechanical tools must NOT be used to tighten coupler nuts as this may cause damage which will invalidate your warranty.

## 4 General plumbing

**The installation must comply with the relevant requirements or local by-laws.**

**The pump MUST be mounted upright (shaft horizontal, not screwed down).**

**Jointing compounds, Boss White, hemp or steel wool MUST NOT be used. Solder fluxes must not come into contact with the pump or AV couplers.**

**The maximum static head should be 10m (equivalent to 100kPa/1.0 bar pressure) with the exception of the RP50TU where the maximum static head should be 5m (equivalent to 50kPa/0.5bar pressure)**

**The plumbing installation must comply with “The Water Supply (Water Fittings) Regulations 1999” and “BS EN 806-4:2010” buildings regulations.**

## 5 Electrical requirements

The pump must be connected to the electrical supply using the mains cable with the attached plug. This plug must be connected to an accessible socket that has been installed in compliance with BS 7671 (I.E.T. Wiring Regulations). The plug must be accessible at all times.

The pump must not be installed in a bathroom unless it is installed in an enclosed space accessible only with the use of a tool.

If the supply cord is damaged, it must be replaced by the manufacturer, its service agent or similarly qualified person in order

Pump	Fuse
RP55PS, RP80PS and RP120PS	3 amp
RP50PT	3 amp
RP75PT and RP100PT	5 amp
RP55SU, RP80SU, RP120SU and RP50TU	3 amp
RP75TU and RP100TU	5 amp

We recommend that the pump is run for at least 5 minutes every 4 weeks in order to exercise all working parts.



# Typical installations – Right positive head pumps

The selection of the Right positive head pump for a system will be determined by the resistance of, quantity of and pressure required by, the outlets.

In these systems:

- Toilets **MUST** be fitted with an equilibrium ball valve.

Figure 6: Right pump fitted in loft above cylinder outlet

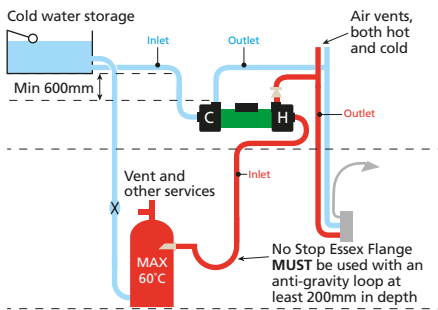
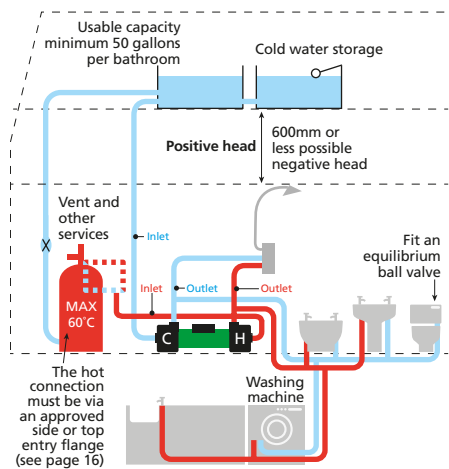
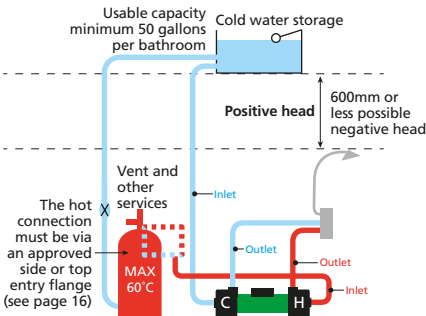

Figure 8: Whole house system

Either side of these pumps can be used for hot or cold water.



In positive head systems, allow for increased resistance of long pipe runs with multiple bends. The natural flow from the outlets **MUST** be at least 2 litres/min mixed on hot and cold.



# Right Universal Pumps - system operation and L.E.D. indication

Right Universal pumps are designed to protect customers by responding to unexpected and unforeseen conditions. Right Universal pumps will only be switched OFF if the unexpected or unforeseen conditions are serious.

Right Universal pumps capable of:

- Supply water temperature sensing
- Dry run protection
- Sensing chronic aeration or water starvation
- L.E.D indication of unforeseen system malfunction.

System malfunction is indicated by three L.E.D's located on the top of the pump junction box. see Figure 9.

**NON RETURN VALVES MUST NOT be fitted in the discharge pipework between the pump outlets and the system outlets unless specified by Salamander Pumps.**

Figure 9: L.E.D. indicator

## ! IMPORTANT NOTE

- The HOT and COLD pump ends are identified by RED (hot) and BLUE (cold) tie

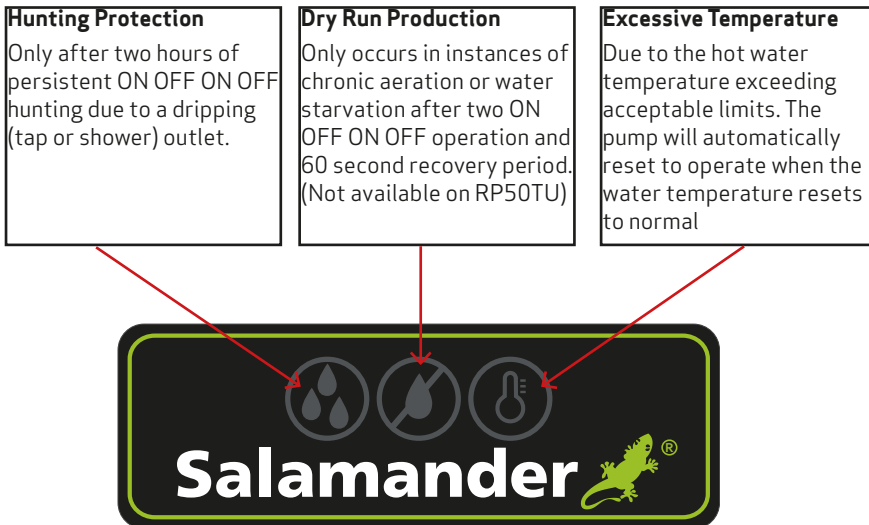

## Right universal pumps

A right universal twin pump to a bathroom in a loft-conversion.

Figure 10: Negative head

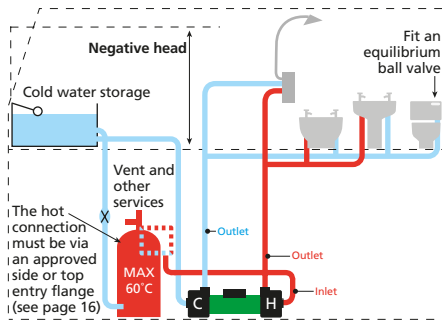

## Right pumps (positive head)

Right universal twin pumps to a whole house system. In these systems TOILETS must be fitted with equilibrium ball valve(s).

Figure 11: Positive head

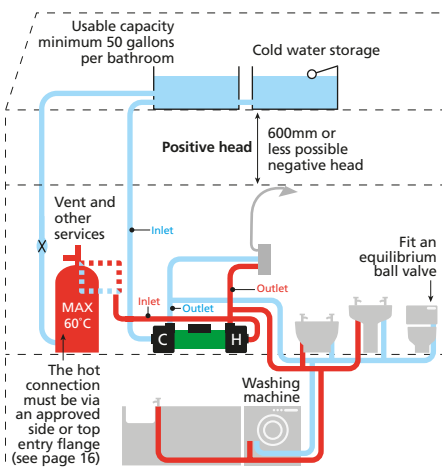

## Negative head systems

Negative head systems exist where no natural flow of water goes to the outlet because either the outlet or the pipework to the outlet are above the height of the base of the cold water cistern. Most instances of negative head systems occur in loft conversions or where the cold water cistern sits on the joists in the loft. If the distance between the bottom of the cold water cistern and the highest point of the system after the pump is 2 feet (610mm) or less, it is also possible that a universal pump will be required. Salamander's universal range of pumps activates the pump automatically even where no natural flow exists.

Negative head is also needed for electric showers, dishwashers, washing machines or where pumped hot water meets mains cold.

## Typical installations – Right Universal Pumps

### Right universal pumps to shower columns or steam shower cabinets

These systems will be Negative Head where the pipework runs above the tank.

Figure 12: Right universal pump to a shower column

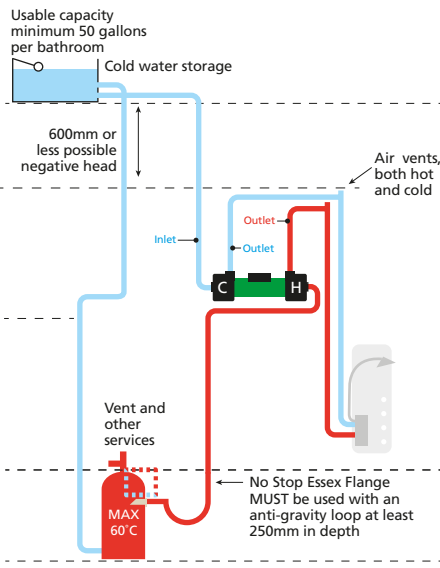

Right pump universal to a shower cabinet. Shower columns and steam shower cabinets in larger whole house systems or systems with multiple bathrooms will be best served by two single-ended Right Universal pumps.

### Single-ended Right Universal pump

The following systems are best accommodated by using a single-ended Right Universal pump which is complete with a pressure vessel and electronic system protection.

Right universal pump to boost tank fed supplies to instantaneous electric showers and water heaters.

Figure 13: Instantaneous electric showers and

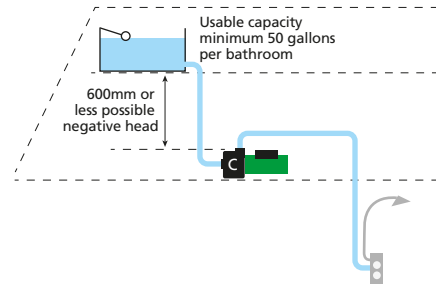

water heaters

Tank fed, pressurised cylinder or combination boiler system with single-ended Right Universal pump to boost the hot supply water pressure and cold water mains supplies 'cold' to shower, bath, basin and toilet.

Figure 14: Pressurised cylinder or Combination boiler system

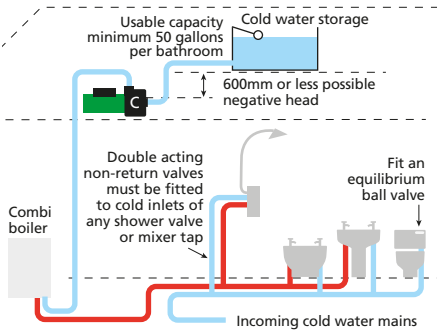

Tank fed (hot) with cold water mains systems **MUST** use Right Universal pumps  
 Never use a single-ended Right Universal pump after the shower valve or before an open outlet.

Figure 15: Tank fed (hot) with mains cold

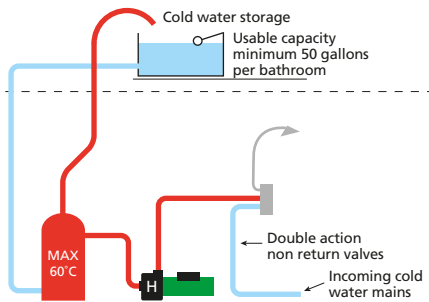

## Commissioning

### ! Before you finish

- Flush inlet pipework and carefully fill pump with water by discharging water from the outlet flexible coupler into a container.
- Fit pump inlet filters.

! It is **CRITICAL** to discharge water through the pump into a container using natural flow before connecting the pump to outlet pipework in order to ensure the air has been discharged from inlet pipework and pump chambers. This will not happen if the outlet pipework is connected to the pump. The best method is:-

Figure 19

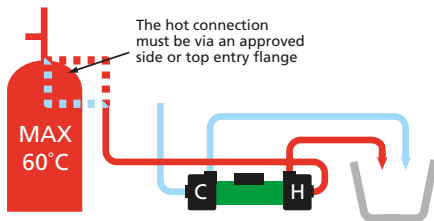

- Connect discharge pipework.
- **Check that all the pump isolating valves are open.**
- Fill system. Check for leaks.

- **DO NOT RUN PUMP DRY – to do so will cause irreparable damage to your pump and will invalidate your warranty.**
- Open shower mixer valve/system outlets to maximum hot and cold to check the natural flow (unpumped) flow of at least 1 litre per minute – positive head systems.
- Open hot water outlets fully for 5 to 6 seconds and then turn outlets off. Then open cold water outlets fully for 5 to 6 seconds and turn outlets off. If flow is poor and inconsistent repeat above steps until flow is steady.
- Repeat 2-3 times.

# Helpful PumpWise guidelines

## Cold water supplies and storage

### Recovery of cold storage

The typical recovery rate of a 1/2 inch high pressure part II BS1212 ball valve is:

100 kPa (15PSI/1.0 bar)	0.97 galls/min	4.41
200 kPa (30PSI/2.0 bar)	1.34 galls/min	6.11
270 kPa (40PSI/2.7 bar)	1.58 galls/min	7.18
400 kPa (60PSI/4.0 bar)	1.94 galls/min	8.82

### Aeration of pump and cylinder from a cold water storage tank

This occurs when the incoming cold mains ball valve is positioned above the cold feeds to the cylinder and to the pump - aerated water is drawn into the pump as illustrated.

Figure 20: Aeration

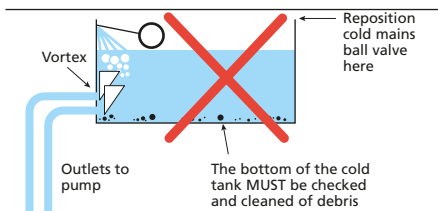

Chronic aeration of the pump occurs when this problem is combined with inadequate storage capacity and/or when the volume of water drawn by the pump and other services exceeds the refill rate and creates a vortex which draws air and possibly debris into the

pump.

### Cold storage usable capacity

The usable capacity of cold storage is easily calculated as the capacity of water in the cold tank above the cold feeds to the cylinder, the pump and other outlets - see formula.

#### Formula for calculation on rectangular tank:

Depth (15") x width (23") x length (36")

= 12,420 cu inches

Volume cu inches (12,420) x 0.01639

= 203.56 litres

Volume litres (203.56) x 0.22

= 44.78 gallons.

#### Formula for calculation on circular tank:

Depth (15") x radius (17") x radius (17") x 3.142 (Pi)

= 13,621 cu inches

Volume cu inches (13,621) x 0.01639

= 223 litres

Volume litres (223) x 0.22

= 49 gallons.

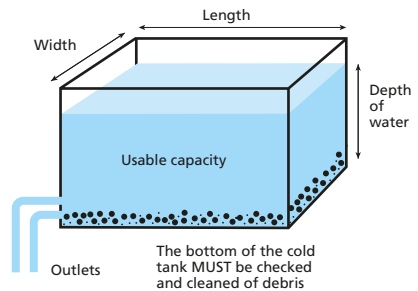

Figure 21

### Pre-plumbed direct or indirect combination units

These are purpose-made units typically for use in multiple flat developments, usually in towns and cities where it is advantageous and desirable to provide the occupants with completely independent hot and cold water services.

In these systems the ideal pump is an RP50/75 TU. For alternative types of combination units see Elson, Figure 23 and Fortic (type), see Figure 24.

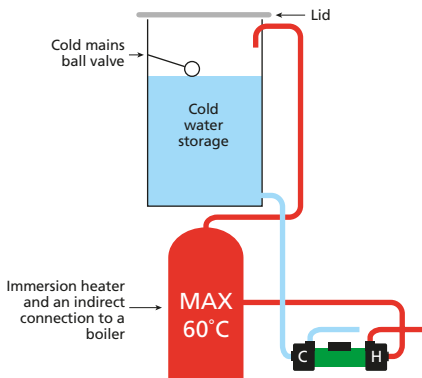
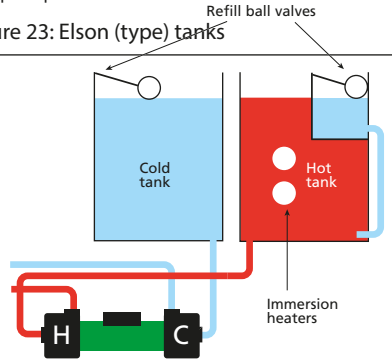

Figure 22: Pre-plumbed direct or indirect combination units

### Elson (type) tanks

In these systems it is important to ensure the hot and cold water storage capacity is adequate for the type of pump to be used. The refill ball valve on the small cold tank which refills the hot tank is correctly set to prevent aeration of the hot supply water to the pump.

Figure 23: Elson (type) tanks



### Fortic (type) tanks and pre-assembled units

Typically used in very small flats and houses. Not usually with sufficient water capacity of cold water for pumped systems.

Figure 24: Fortic (type) tanks and pre-assembled units

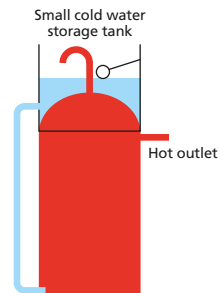



# Helpful **PumpWise** guidelines

## Water starvation protection, pipework arrangements and stored hot water

Please be advised due to lack of cold water storage with Elson and Fortic (type) tanks, our pumps may not be suitable. It is advisable to contact our Technical Support team before installing the pump on 0191 516 2002, otherwise it may affect your warranty.

### Water starvation protection

In systems where it is absolutely not possible to increase the usable cold water storage capacity to meet the increased demand of a pumped system; a water starvation protection unit (WSP) may be considered.

The WSP is a Salamander level switch which must be positioned 102mm higher than the highest outlet from the cold water storage tank. When the water level drops too far the WSP will switch off the pump until the cold water storage level is recovered.

Figure 25: Water starvation protection unit (WSP)

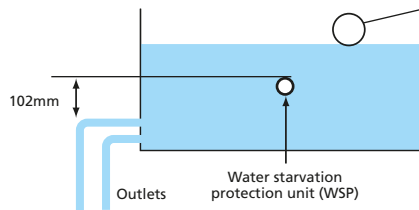

### Shower head size vs bar pressure

The size of a shower head dictates the bar pressure of the pump required to deliver the expected performance of the shower.

Shower head diameter	Bar pressure
Up to 5cm	1.5 bar (150 kPa)
5-10cm	2.0 bar (200 kPa)
10-12.5cm	2.5 bar (250 kPa)
More than 12.5cm	3.0 bar (300 kPa)

### Anti-gravity loops

An anti-gravity loop (AGL) must always be fitted to systems where the pump is positioned above the hot outlet from the cylinder. The AGL which limits aeration of the hot supply to the pump is formed by bending the pipework downwards for 250mm, as it exits the Essex Flange, before rising again to the pump. See Figure 26 overleaf.

Figure 26: Anti-gravity loop (AGL)

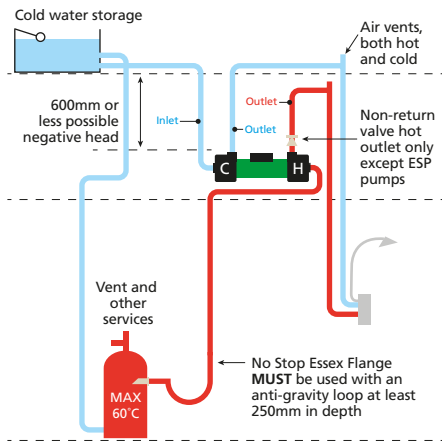

### Combi boilers and water heaters

As these appliances are invariably supplied directly from the cold mains – they are not normally suitable for booster pumps. The exceptions are featured in Figure 14 on page 10.

Figure 27: Combi boilers

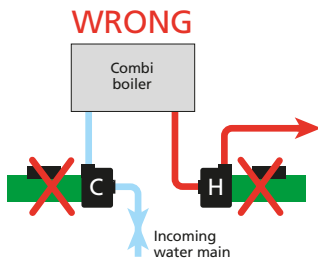

### Horizontal cylinders

As horizontal (torpedo) cylinders are problematic for boosted systems consult PumpWise for guidance and correct use of an approved top entry flange.

Figure 28: Horizontal cylinders

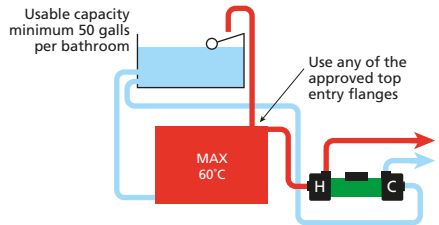

### Approved flanges (cylinders)

The 22mm No Stop Essex and the other approved top entry flanges with extension pipes into the cylinder represent the best known means of ensuring minimal aeration of the hot supply water to the pump. The No Stop Essex flange is in all circumstances the best option.

### S flange

Complete with compression 'pump' and 'open vent' connections. Also supplied with an adaptor to connect to 1" 'male' and 'female' top entry cylinders.

Figure 29: S flange

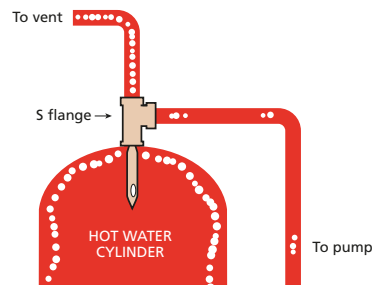

### York flange

These may be used in systems where the hot water requirement is less than 20 Litres per minute.

## Warix flange

- A The Vent connection **MUST** be from side in Warix Flange.
- B The supply connection to the pump **MUST BE FROM THE TOP** of the Warix Flange via a 22mm compression elbow and thereby avoid inverted loops.
- C In systems where there are one bathroom and an en-suite shower. Or two or more bathrooms the cold feed to the cylinder **MUST** be in 28mm pipework.

Figure 30: Approved flanges

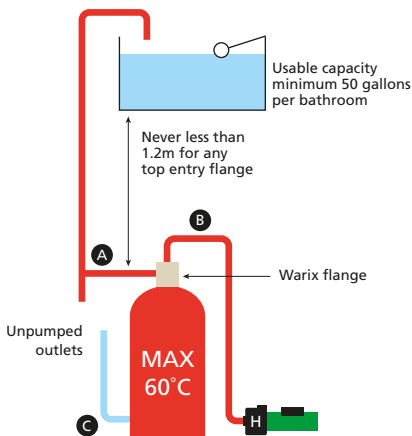

## Inverted loops

An inverted loop in the supply pipe-work to the pump, particularly on the hot side as illustrated; is likely to:

- interfere with the initiation and smooth operation of the pump.
- restrict the supply water to the pump and risk internal mechanical damage.

Figure 31: Inverted loops

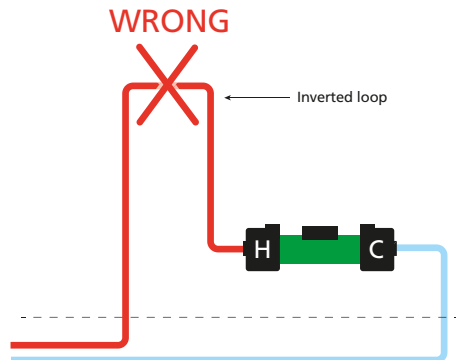

Prismatic cylinders and Andrews type water heaters are not suitable for pumped systems.

## Water hammer protection

Water hammer most commonly occurs in systems where there are long pipe runs supplying solenoid activated appliances e.g. washing machines or outlets with quick acting/turn taps/ valve(s). The harmful effect of water hammer shock waves can be cushioned by fitting a pressure vessel unit, into the supply pipework as close as possible to the outlet from which the shock waves are originating.

Figure 32: Water hammer protection

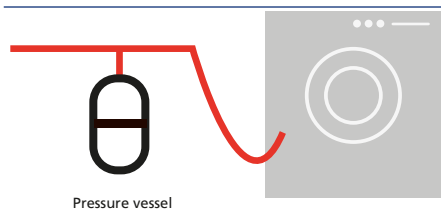

## Pump hunting protection

In negative head systems all the discharge pipework after the pump is pressurised. In such systems there exists the possibility the pump will hunt ON-OFF-ON etc at intervals.

This will happen:

- if all outlets are not fully closed
- if there is a leak at a connection
- if boosted toilets are not fitted with equilibrium ball valves
- or as residual hot water contracts in long pipe runs.

The irritating effects of hunting are cushioned by the pressure vessel which is an inbuilt feature of Right Universal pumps.

## Stored hot water volume

In calculating the volume of the stored hot water requirement it is important to consider:

- number of bathrooms, with particular attention to the size of the bath
- number of persons in household
- time spent in shower e.g. 10mins in a 5 gall/minute shower will use up 50 galls/227 Litres of the cold water storage capacity approx 60% of which (30 gallons/136 Litres) will be hot water from the cylinder.

## Stored hot water temperature

Extract from BS5546:1990 (Current)

“The mean temperature of the stored water should not normally exceed 60°C and in a combined central heating and domestic

hot water system it is recommended that the stored water temperature is controlled independently from that on the primary circuit”.

Extract from BS6700:1997

“Under normal conditions the temperature of stored hot water should never exceed 65°C. A stored hot water temperature of 60°C is considered sufficient to meet all normal requirements and will minimise scale deposits in hard water areas”.

Effective control of stored hot water is simply achieved by use of a cylinder thermostat and zone valve or direct acting thermostatic valve (e.g. tapstat).

In systems where the stored hot water temperature is not controlled eg Aga solid fuel appliance or very crudely by the boiler thermostat, use a HWS Blending valve controller.

## HWS Blending valve controller

The HWS Blending valve controller is designed to protect booster pumps in

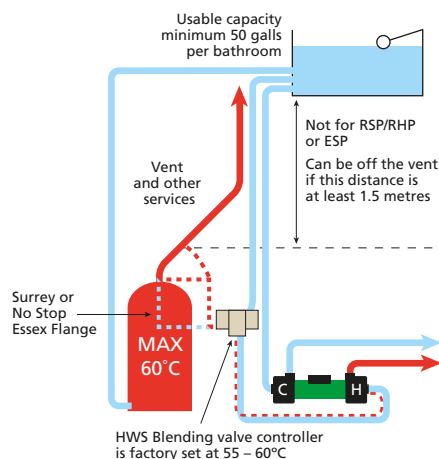

# General specification

## Applications

All Salamander pumps are designed to boost low pressure hot and cold supplies from tank-fed services.

## Voltage

220-240 volts 50 Hz.

## Motor type

Capacitor start and run induction type motor with stainless steel shaft and in-built resetting thermal protection (complies with BS5000 part 11).

## Pump materials

All moulded components are manufactured from Acetal Copolymer.

## Maximum head

RP 50 TU and RP 55 SU            5 metres

All other pumps                    10 metres

Pumps fitted with RCM3 maximum 3 metres static head.

## Pump noise

With the technological advances achieved in Right pumps, Salamander has taken another step forward in the quest to supply all our customers with even quieter centrifugal pumps. Despite this no pump is completely silent.

Correct installation will minimise vibration and transmission noise.

## Patents

Our Right range of pumps is protected by following patent: Hydraulic Pump - GB2402444

## Mechanical seals

Scale deposits in water supplies can cause the mechanical seal to stick if left for long periods without use. We recommend the pump be ran at least five minutes every four weeks to 'exercise' all working parts.

## Connections

3/4" BSP male.

## Initiation

Fully automatic, flow switch operated, requiring 1 litre in 30 sec per side or 2 litre in 30 sec mixed. Except Right Universal pumps when required to operate in negative head mode.

## Temperature

Maximum fluid temperature 60°C.

## Standards and approvals

Splash proof rating IPX2.

Complies with the requirements of current British and European safety standards for household and similar electrical appliances.

Complies with European Community Directives (CE).

The company operate a policy of continuous development and reserves the right to change any of the specifications of its products without prior notice. All information data and illustrations given in this leaflet may be subject to variation.

Pump Model		RP50PT	RP75PT	RP100PT	RP50PS	RP80PS	RP120PS
General	Guarantee	2 Years					
Features	Pump Type	Centrifugal					
	Mechanical Seal	Nitrile/Carbon/Ceramic					
	Inlet Isolator(s)	•	•	•	•	•	•
	Flexible Hoses	4	4	4	2	2	2
	Dry Run Protection						
Performance	Pressure @ 16lpm	1.0 bar	1.2 bar	2.7 bar	1.0 bar	1.8 bar	3.0 bar
	Pressure @ 8lpm	1.2 bar	1.6 bar	2.9 bar	1.2 bar	2.1 bar	3.3 bar
	Pressure @ Closed head	1.5 bar	2.0 bar	3.1 bar	1.5 bar	2.4 bar	3.6 bar
	Maximum Water Temperature	60°C					
Connections	Pump Connections	3/4" BSP					
Flexible hoses	Connections (UK Model)	3/4 Female x 22mm push-Fit x 280mm long, isolating valves on all hoses					
	Connections (ROI Model)	3/4 Female x 21mm push-Fit x 280mm long, isolating valves on all hoses					
Motor	Type	A.C Induction Motor					
	Duty Rating	Continuously Rated					
Electrical	Power supply	230 V					
	Current (full load)	1.30 amps	3.10 amps	4.40 amps	1.20 amps	1.70 amps	2.20 amps
	Power consumption	320 watts	740 watts	1050 watts	250 watts	400 watts	520 watts
	Fuse rating	3 amps	5 amps		3 amps		
	Power cable (pre-wired)	1.5 metres					

Pre-installation  
 Installation  
 PumpWise guidelines  
 General specification  
 Trouble shooting  
 PumpWise and warranty

Pump Model		RP50TU	RP75TU	RP100TU	RP50SU	RP80SU	RP120SU
General	Guarantee	2 Years					
Features	Pump Type	Centrifugal					
	Mechanical Seal	Nitrile/Carbon/Ceramic					
	Inlet Isolator(s)	•	•	•	•	•	•
	Flexible Hoses	4	4	4	2	2	2
	Dry Run Protection	•	•	•	•	•	•
Performance	Pressure @ 16lpm	1.0 bar	1.6 bar	2.5 bar	1.0 bar	1.9 bar	2.9 bar
	Pressure @ 8lpm	1.2 bar	1.9 bar	2.8 bar	1.3 bar	2.1 bar	3.2 bar
	Pressure @ Closed head	1.5 bar	2.1 bar	3.0 bar	1.5 bar	2.3bar	3.4 bar
	Maximum Water Temperature	60°C					
	Pressure Vessel Air Pre-Charge	8 psi	14 psi	20 psi	8 psi	14 psi	20 psi
Connections	Pump Connections	3/4" BSP					
Flexible hoses	Connections (UK Model)	3/4 Female x 22mm push-Fit x 280mm long, isolating valves on all hoses					
	Connections (ROI Model)	3/4 Female x 21mm push-Fit x 280mm long, isolating valves on all hoses					
Motor	Type	A.C Induction Motor					
	Duty Rating	Continuously Rated					
Electrical	Power supply	230 V					
	Current (full load)	1.30 amps	2.70 amps	4.50 amps	1.20 amps	1.70 amps	2.20 amps
	Power consumption	320 watts	640 watts	1050 watts	250 watts	400 watts	500 watts
	Fuse rating	3 amps	5 amps		3 amps		
	Power cable (pre-wired)	1.5 metres					

## Trouble shooting

Fault	Probable cause	Recommended solution
Pump will not start	Electrical	Check power supply Check fuse Check circuit breaker
	Inlet/outlet connections incorrect	Check that connections are plumbed the correct way round and all valves are open
	Insufficient gravity flow	Check that installation complies with Salamander instructions Check suitability of pump - is installation in negative head (see page 9) Check inlet filters are not blocked Check flow rate min of 2l/min required on both hot and cold
	Float sticking in outlet	Ensure no debris is in outlet area
	Flow switch malfunction	Contact PumpWise on 0191 5162002
Pump will not start – Right Universal pumps additional checks	L.E.D. warning light lit	See below conditions
	L.E.D. 1 lit (pump hunting)	Check all outlets are fully closed and there are no leaks on outlet pipe work If fitted to toilets ensure ball valve in cistern is not passing water Ensure equilibrium ball valve fitted
	L.E.D. 2 lit (aeration - starvation of water)	Check cold water storage is correct for installation and pump is fitted to Salamander instructions Flange fitted Check pump filters are clear of debris
	L.E.D. 3 lit (temperature)	Is effective temp control fitted (cylinder stat or HWS/TMV valve)?



<b>Fault</b>	<b>Probable cause</b>	<b>Recommended solution</b>
Reduced/ intermittent flow	Incorrect or no anti-aeration flange	Check that installation complies with Salamander instructions
	Insufficient gravity flow	See above
	Blocked inlet filters	Ensure that all filters and shower head are free from debris
	Couplers restricting flow	Ensure that all AV couplers are straight and not bent or
	Air in system	Run system on full hot with pump switched off (i.e. gravity only) for several minutes Check cold water storage is correct for installation and pump is fitted to Salamander instructions Ensure cold water refill rate is adequate for installation Check that vents are fitted as described in instructions
	Wrong size pump for system	Ensure pump is sufficient to run the equipment
	Hot temp set too high	Reduce cylinder stat setting to 60°C max or fit HWS/TMV
Pump starts with all outlets closed	Leak in system	Check for leaks
	Outlet open	Ensure all outlets are fully closed or capped - i.e. no dead legs in pipework
Pump is noisy	Air in system	See above
	Pump vibrating on	Ensure rubber feet are fitted to pump
	AV couplers causing vibration	Ensure that all AV couplers are straight and not bent or distorted
Pump is leaking	Pump exposed to mains water pressure	Check that installation complies with Salamander instructions
	Pump has suffered chemical damage	Ensure that the pump has not come into contact with chemical substance i.e. solder flux
	Pump exposed to excessive temperature	Is effective temp control fitted (cylinder stat or HWS/TMV valve)?
	Pump appears to have leaked but not sure	Check leak is not from fitting in pipework above pump

## PumpWise and warranty

0191 516 2002

**Monday to Thursday 8.30am to 5.30pm**

**Friday 8.30am to 5.00pm.**

PumpWise is the cornerstone of Salamander's support service to customers and the means by which our customers are guaranteed:

- Selection of the right pump for the job
  - With more than 30 pumps in our range, the PumpWise team can help you to choose the pump that's most suitable to your specific installation
- The avoidance of installation pitfalls
  - Due to the technical nature of our products, it is essential that they are fitted according to our installation guidelines. The PumpWise team are available to talk through any installation questions and provide technical support and guidance.
- A third year's warranty FREE
  - All of our right pumps come with a full two year warranty, but following installation of your new pump, if your installer calls our PumpWise team, registers your pump and runs through the system installation you may be eligible for a third years warranty free.

### Our PumpWise commitment

Our PumpWise helpline is here to help you and we aim to provide a support service second to none. Installers and customers can be sure of a speedy response to requests for technical help, guidance and advice.

### Your warranty

Salamander customers benefit from a full two year warranty on the Right pump range. This warranty will operate from the date of purchase and is subject to the installation guidelines being followed correctly (please refer to our Pre-Installation Checklist, on page 2 and our Commissioning Checklist, on page 11). This warranty could be increased free of charge, if the installer contacts our Pumpwise team on 0191 516 2002 at the time of initial installation, to register the pump and run through the installation with our Technical Team. Providing the pump has been installed according to our guidelines, you will receive a third year's warranty free of charge (UK only).

Please complete and return the attached warranty card.

### Extended warranties

In addition to the three year warranty available free of charge following the successful installation of your pump, there is an optional Extended Warranty Scheme (UK only). The Extended Warranty Scheme exists to protect customers from any unexpected or unforeseen pump breakdowns. Participation in the Extended Warranty Scheme is activated by completion of an Extended Warranty Application Form and the payment of a nominal fee.

For further details please contact the PumpWise team:

**Telephone: 0191 516 2002**

**Fax: 0191 548 4445**

**Email: [tech@salamanderpumps.co.uk](mailto:tech@salamanderpumps.co.uk)**

PLEASE NOTE: Incorrect installation may invalidate the pump warranty.

# To the installer

Please follow the guidelines for installation provided in this brochure and call the PumpWise helpline for installation advice. Once installation has been completed and the system has been tested to your satisfaction, please assist the customer in completing the prepaid Warranty Card.

## Terms, conditions and warranty

### 1 The Scope of the Warranty

SALAMANDER PUMPED SHOWER SYSTEMS LTD ("the company") Warrants subject to the terms and conditions below for the Warranty period(s) specified in paragraph 3 that the Company shall:

Repair or replace free of charge the product(s) specified on the Warranty card or any component part thereof (together referred to as "the equipment") which shall in the opinion of the Company have proved defective by reason only of the Company's materials or workmanship providing always that the Company shall be under no obligation whatsoever under this Warranty to repair or replace equipment which have been misused, tampered with, modified/alterd in any way without the consent in writing of the Company or if any component or accessory shall have been replaced by a type not specified by the Company or if the equipment is incorrectly installed or operated or used other than as described in the instruction manual or if any servicing or repair of the equipment shall have been carried out otherwise than by an authorised Company dealer appointed by the Company ("dealer").

The Company's liability under this Warranty is limited to the said repairs or replacement and shall under no circumstances extend to any financial loss or damage including consequential losses alleged to have been suffered by the claimant.

Subject as provided in this warranty and except where the equipment is sold to a person dealing as a consumer all warranties, conditions or other terms implied by law are excluded to the fullest extent permitted by law.

Nothing in this warranty shall exclude liability for death or personal injury caused by the Company's negligence

### 2 Terms and conditions

This Warranty shall only be enforceable by you if the following terms and conditions have been complied with:

- a That the pump has been installed in accordance with the installation instructions, guidance and advice contained within the installation and warranty guide and/or provided by the Salamander help desk.
- b You are the original purchaser of the equipment from a dealer and not an assignee or subsequent purchaser of the equipment.
- c You must evidence the date of purchase by retaining the original invoice from the dealer. Without such evidence the Company reserves the right to reject any such claims under the terms of this Warranty.
- d Within 15 days of delivery of the equipment to you the Warranty card is accurately completed and returned to the Company.
- e Within 30 days of discovery of a defect giving rise to liability under paragraph 1 above you give notice thereof in writing to the Company.
- f Provided the pump has not been altered, tampered with, modified or transformed in any way.

### 3 The Warranty periods

The Warranty periods referred to in paragraph 1 above are as follows:

- a Products manufactured by the Company 2 years from date of purchase provided the warranty card is completed and returned to the Company within 15 days of purchase.
- b Products supplied by the company, but are not of the company's manufacture come with 30 day warranty from date of purchase. Anti-Vibration Couplers (hoses) come with 1 year from date of purchase.
- c The warranty period in respect of any product repaired or replaced under the warranty shall be part of the above period(s) which remain unexpired.
- d In the event of a claim for repairs or replacement being made under the terms of this Warranty, a visit from a Salamander service engineer may be necessary. Engineer visits are not covered under/ part of the warranty agreement. In circumstances where in the opinion of the Company the defect has not been caused by the Company's materials or workmanship, then the Company reserves the right to charge the claimant at its current hourly rates and list prices in respect of any service engineer's time and replacement of any parts. Please speak to our Technical Support team for further details and confirmation of costs.
- e This Warranty is given in addition to and does not affect your statutory rights as a consumer.
- f This Warranty is valid and enforceable for equipment purchased and used exclusively within the UK and the Republic of Ireland only.
- g Where the Company issues a replacement the equipment replaced shall be returned to the Company for twith and shall become the property of the Company.





Freeport RLXE-JHHY-HLHJ  
Salamander Pumps  
Unit 2c Colima Avenue  
Sunderland  
SR5 3XE

2

