

KUBE 18/10 STAINLESS STEEL INSET OR UNDERMOUNT SINK

KUBE34/



Size: 380 x 440 mm

The Kube undermount kitchen sink collection creates a geometric effect thanks to its dramatic 10mm radii corner profiling. The newly designed Kube range is equipped with dual fix fittings and enhanced with an upgraded waste kit and cover.

- Dual installation methods with both clips included, choose to either inset or undermount fit the Cubix range
- Slim profile top plate which sits flat against worktop when fitted as inset
- Hygienic rectangular overflow design
- Waste kit and waste cover included

RANGEMASTER

SINKS & TAPS

Material	18/10 Stainless Steel
Material Gauge	1.0
Material Finish Bowl	Micro-Sheen™ Soft Brushed Finish
Material Finish Drainer	Micro-Sheen™ Soft Brushed Finish
Drainer Position	
Overall Length (mm)	380
Overall Width (mm)	440
Main Bowl Length (mm)	340
Main Bowl Width (mm)	400
Main Bowl Depth (mm)	200
Second Bowl Length (mm)	-
Second Bowl Width (mm)	-
Second Bowl Depth (mm)	-
Tap hole Size (mm)	
Waste Size (mm)	1 x 90
Waste Kit	Included with sink (1 x 90mm square BSW and overflow kit)
Min. Base Unit (mm)	450
Cutout Size Length (mm)	340 (undermount) / 364 (inset)
Cutout Size Width (mm)	400 (undermount) / 424 (inset)
Warranty Sinks (years)	25
Product Code	KUBE34/
Barcode	5015834057095

Date of download: March 19, 2025

AGA Rangemaster continuously seeks improvements in specification, design and production of products and thus, alterations take place periodically. Whilst every effort is made to produce up-to date resources, the information included here is intended as a guide. Always refer to the product's installation instructions when fitting, installation work should be completed a professional tradesman.

KUBE 18/10 STAINLESS STEEL INSET OR UNDERMOUNT SINK

KUBE34/

Technical Drawing

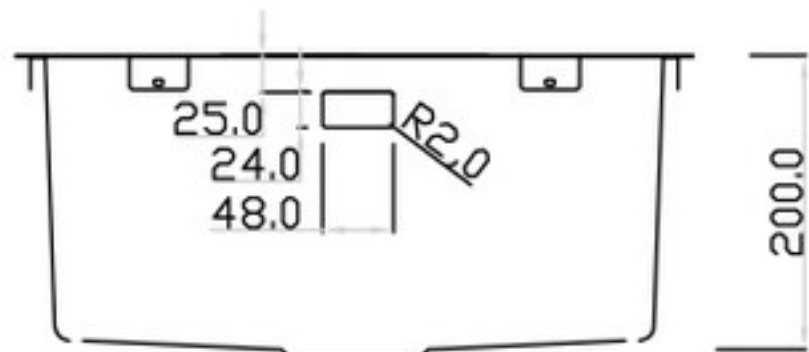
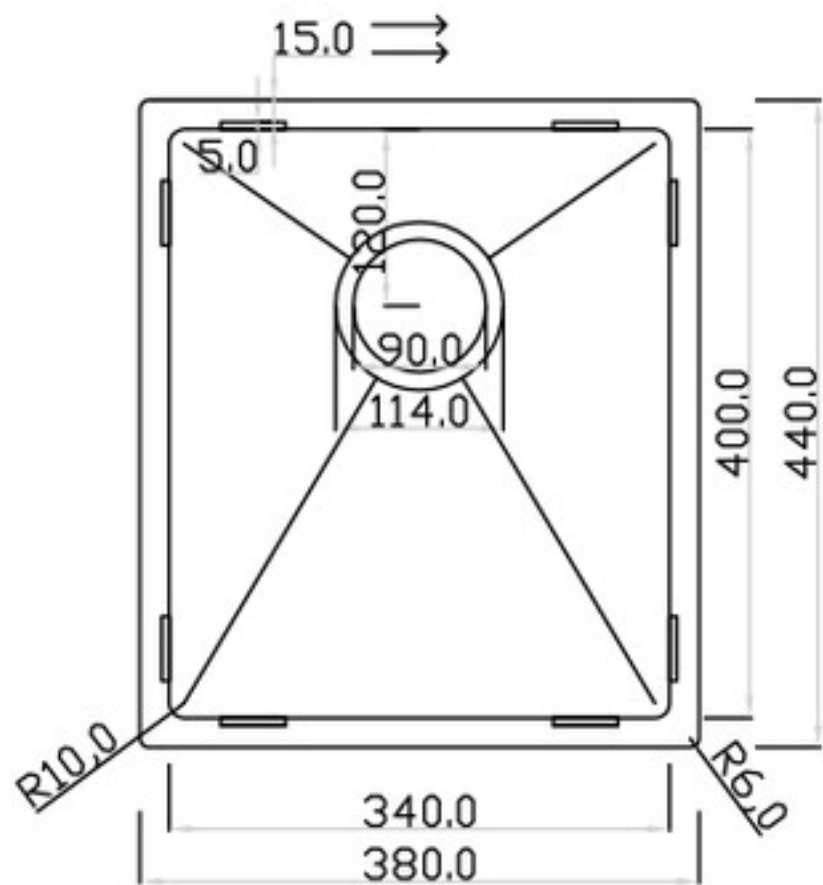

Date of download: March 19, 2025

AGA Rangemaster continuously seeks improvements in specification, design and production of products and thus, alterations take place periodically. Whilst every effort is made to produce up-to date resources, the information included here is intended as a guide. Always refer to the product's installation instructions when fitting, installation work should be completed a professional tradesman.

KUBE 18/10 STAINLESS STEEL INSET OR UNDERMOUNT SINK

KUBE34/

Cut Out Template

Dimensions in mm. Not to scale.

Undermount Installation

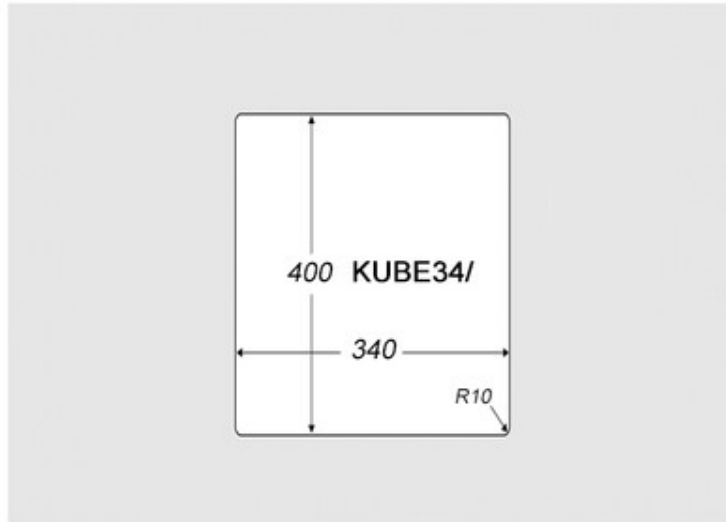

Inset Installation

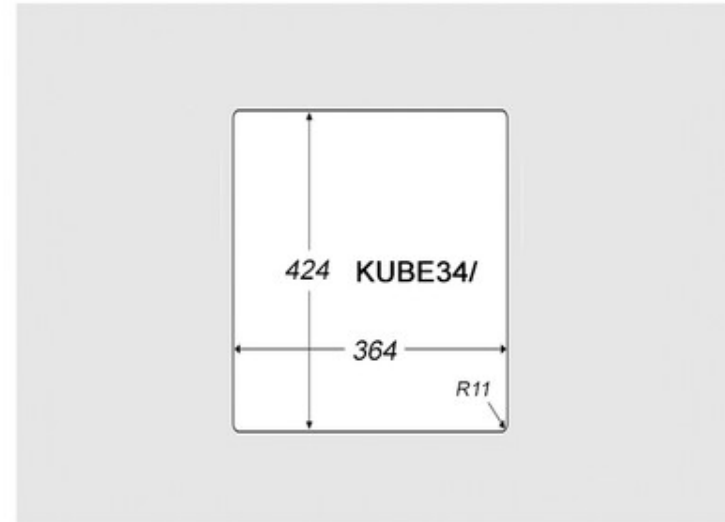

Date of download: March 19, 2025

AGA Rangemaster continuously seeks improvements in specification, design and production of products and thus, alterations take place periodically. Whilst every effort is made to produce up-to date resources, the information included here is intended as a guide. Always refer to the product's installation instructions when fitting, installation work should be completed a professional tradesman.