

# AREZZO

## Universal Wall Hung Compact Basin

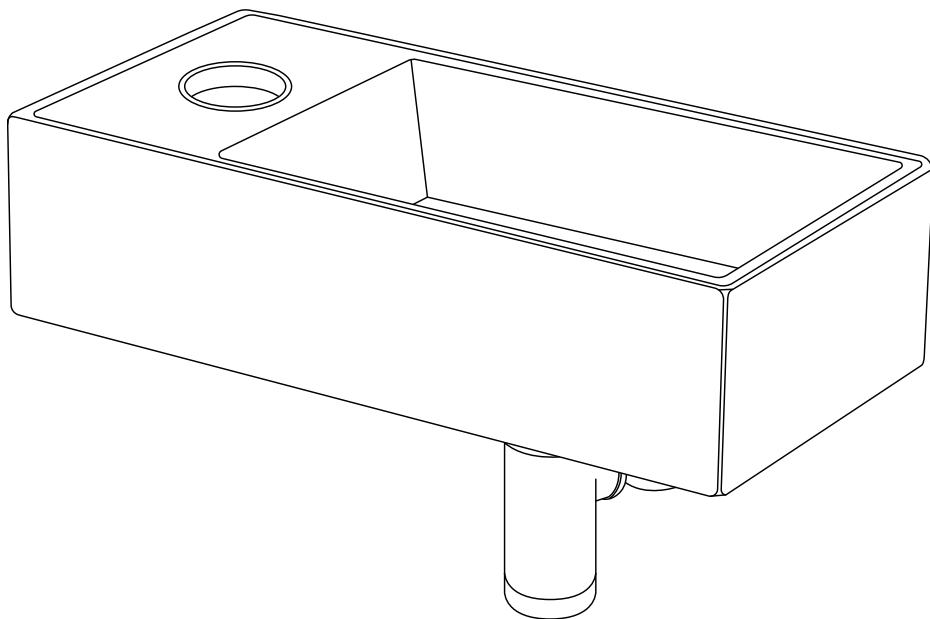

## Fitting Instructions

Please follow them carefully and  
leave this manual with end user



## Before you begin:

1. **We recommend that this product is installed by a qualified tradesperson**, Victorian Plumbing Ltd. accept no liability for products incorrectly installed or any damage to the floor, walls, plumbing, vanity cabinet, sink, counter top, or personal injury during installation.
2. Observe all local plumbing and building codes & regulations.
3. **Attention: Recommended for solid walls only. If fixing to studded timber frame walls, ensure appropriate fixings are used.**
4. Ensure the incoming mains water supply is switched off prior to commencing the installation.
5. For the following instructions, it is assumed that the in-wall plumbing has already been prepared.
6. Unpack the product then read these instructions before proceeding. Inspect the product for damage. If any damage is found, contact our Customer Relations team.

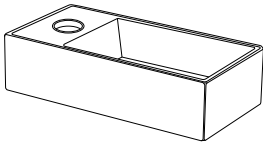
## Items Included:

No.	Description	Picture	Qty
A	Basin		1

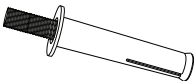
## Recommended Fixings (Not Included):

No.	Description	Picture	Qty
B	Rawl Bolts		2
C	Washers		2
D	Hex Nuts		2

## Tools Required (Not Included):

\*Ensure the appropriate PPE is used during installation\*



Pencil

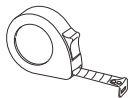

Tape Measure



Power Drill



Spirit Level

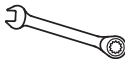

Spanner



Silicone Sealant



Damp Cloth

# Installation

**Note:** Diagrams are for illustration purposes only. Your Basin may differ from these drawings however the installation guide steps still apply.

## Step 1:

Hold the basin up at the desired height. Ensure that the basin is level, then mark the location of the anchor holes. Draw a line underneath the basin to mark the final position.

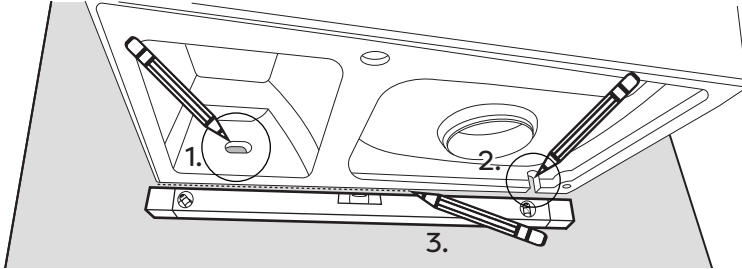

## Step 2:

Move the sink away from the installation location. For ease of plumbing, install the waste and tap (not included) onto the sink before moving on. Carefully drill the holes for the rawl bolts (ensuring the correct sized masonry bit is used when drilling into a solid wall) and insert the rawl bolts (B).

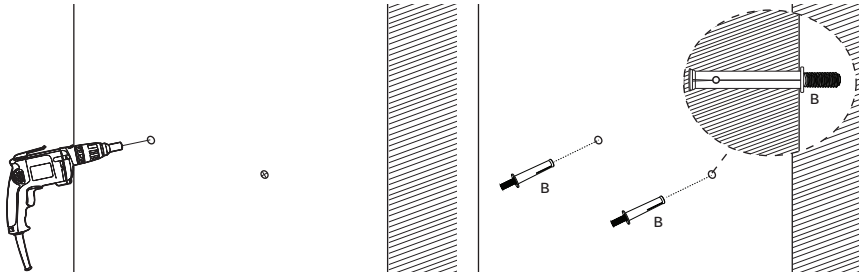

## Step 3:

Pipe a bead of good quality silicone sealant along the rear of the basin.

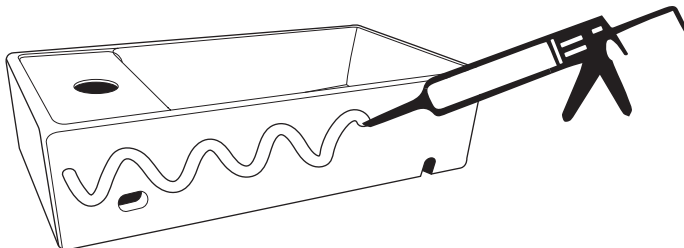

### Step 4:

Place the basin onto the rawl bolts and secure the basin place with the washers (C) and hex nuts (D) provided. Ensure that the basin is level using a spirit level. Wipe away any excess sealant with a damp cloth.

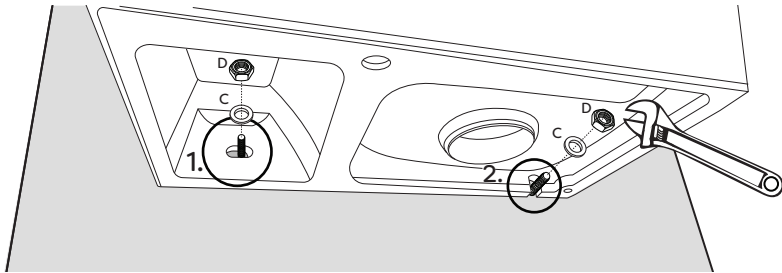

### Step 5:

Proceed to the installation of the drain trap, water supply lines. Refer to their respective installation instructions for guidance if needed. Pipe a fine bead of good quality coloured sealant around the rear edge of the basin. Wipe away any excess sealant with a damp cloth and allow the sealant to fully dry for 24 hours.

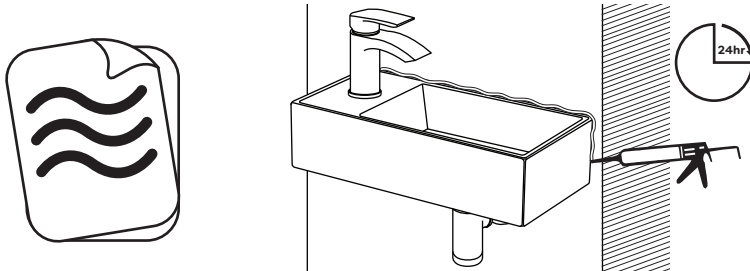

### Cleaning and Maintenance:

We recommend that you regularly clean your basin with a mild dish detergent. After each use, wipe the basin dry with a soft cloth. Do not allow mineral deposits such as iron, salt, lime, or soap to build up on your basin. Refrain from using acidic household cleaners, wipes with harsh chemicals, or abrasives, as these will damage the basin.

### Recycling and Disposal:

Please recycle the packaging in accordance with your local government regulations on waste handling and follow the same advice at the end of the products life.