

Installation instructions

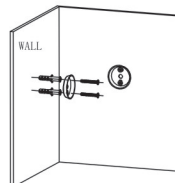

Thank you for purchasing this Victorian Plumbing product. Please follow these care instructions to ensure your product retains its high quality finish - **and retain this leaflet for future reference.**

1. Check all accessories before installation
2. Put Fixed Bases(5) on scheduled location and marked the screw hole on the wall (Transverse distance from the wall 150mm)
3. Bore a hole on marked hole and put Expansion screw(3) in it
4. Put on Fixed Base(5), screw screw(4) tighten



5. When assembling second Fixed Base(5), ensure in the same height, otherwise, the Glasses(2) cannot assemble or tilt

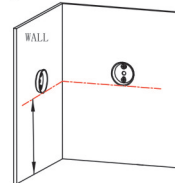

6. Install Bracket (1) and screw on the bottom by S2.5 Allen Key (6).

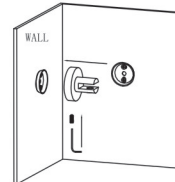

7. Whirl out plastic screw a little

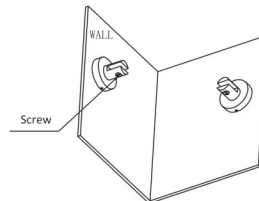

8. Assemble Glasses (2), and screw plastic screw. Put heavy object 5-10KGS to test, avoid falling off, then normal use.

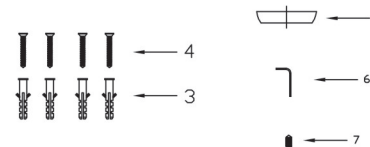
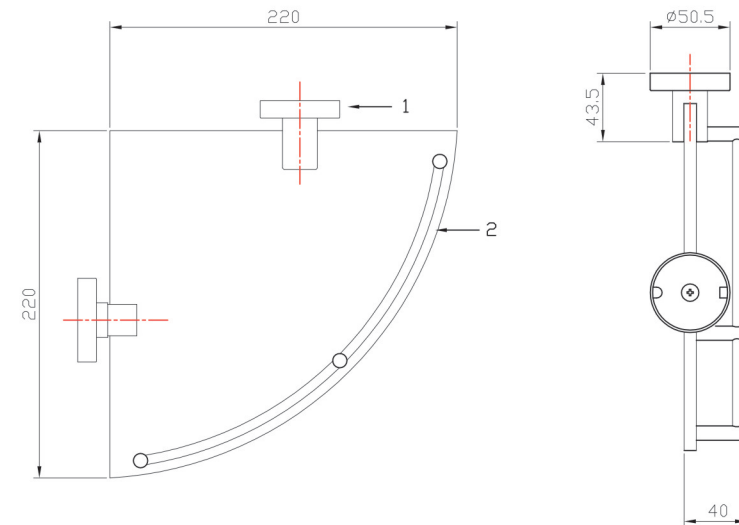
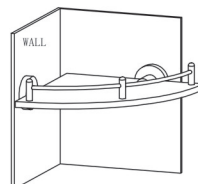

1. Bracket	x 2
2. Glasses	x 1
3. Expansion screw	x 4
4. Screw	x 4
5. Fixed Base	x 2
6. Allen Key	x 1
7. Screw	x 2

Victorian Plumbing

Diamond House. 41, Stephenson Way. Formby Business Park Formby. England. L37 8EG

Tel: 0044 800 862 0878

Website: www.victorianplumbing.co.uk