

MIX Duo QI

Instantaneous Electric Shower
Installation Instructions

IMPORTANT!

**This Step-by-Step guide should be given to the customer
after installation and demonstration.**

CONTENTS & FEATURES

QI

QUICK INSTALLATION a guide for installers

The MX range of QI showers have been especially design for Quick Installation. Both water and electrics can enter the shower unit from 8 different positions. The unit is wired for both left and right orientation. Removable corner units allow for easy plumbing and the filter can be removed quickly and easily without the removal of any parts. Screw mounting hole positions are visible when the cover is off for accurate installation.

PACK CONTENTS



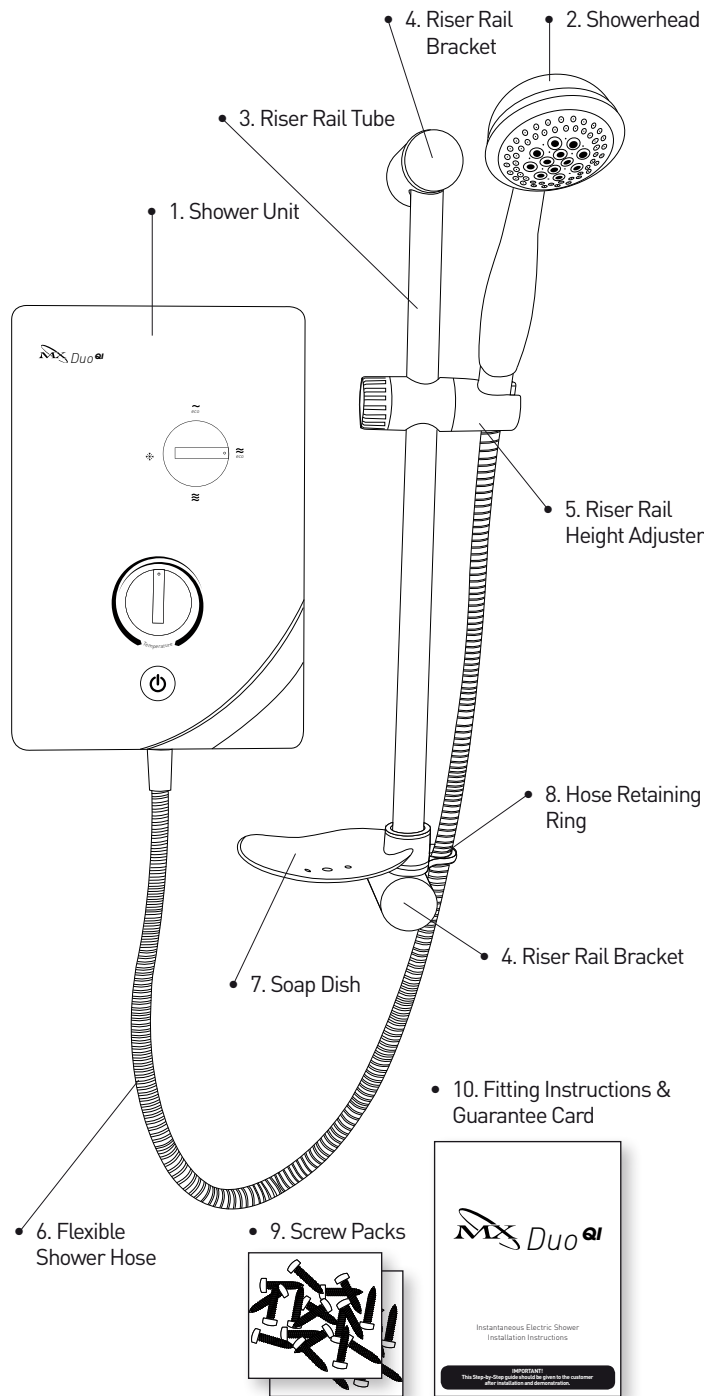

Please make sure all components are included before starting installation.

1. Shower Unit
2. Showerhead
3. Riser Rail Tube
4. Riser Rail Brackets x2
5. Riser Rail Height Adjuster
6. Flexible Shower Hose
7. Soap Dish
8. Hose Retaining Ring
9. Screw Packs
10. Fitting Instructions & Guarantee Card



1. PLEASE READ THIS IMPORTANT SAFETY INFORMATION

Products manufactured by the MX Group are safe and without risk provided they are installed, used and maintained in good working order in accordance with our instructions and recommendations.

-  **WARNING: DO NOT** operate shower if frozen, or suspected of being frozen. It must thaw out before using.
-  **DO NOT** operate the unit if the showerhead or spray hose becomes damaged.
-  **DO NOT** restrict flow out of shower by placing showerhead in direct contact with your body.
-  **DO NOT** operate the shower if water ceases to flow during use or if water has entered inside the unit because of an incorrectly fitted cover.
-  **WARNING:** If restarting the shower immediately after stopping, be aware that a slug of hot water will be expelled for the first few seconds.

These instructions contain all the necessary fitting and operating instructions for your electric shower. Care taken during the installation will provide a long, trouble free life from your shower.

1. PLEASE READ THIS IMPORTANT SAFETY INFORMATION (CONT.)

IMPORTANT: This appliance is not intended for use by persons (Including children) with reduced physical, sensory or mental capabilities, or lack of experience and knowledge, unless they have been given supervision or instruction concerning use of the appliance by a person responsible for their safety. Children should be supervised to ensure that they do not play with the appliance.

DEFAULT PLUMBING SETTING: The shower unit is supplied for right hand installation. To plumb the unit on the left you must remove the blanking cap and refit it to the inlet pipe on the right hand side of the unit ensuring the metal fixing clip is pushed firmly into the groove. When leak testing the installation you must ensure there are no leaks from this area.

IMPORTANT: To comply with water regulations, building regulations or any specific local water company regulations and should be in accordance with BS EN 806. A double check valve must be fitted with all flexible shower accessories where it is possible that the showerhead may come into contact with used water i.e. In the bath or shower tray.

IMPORTANT: Before turning on the water supply to the shower unit the water supply pipe should be flushed out to remove debris. After flushing the pipework ensure that the shower unit is positioned squarely on the wall and tighten the screws. Tighten all plumbing connections and check the pipework for leaks.

IMPORTANT: Ensure that the terminal block screws are fully tightened and that no cable insulation is trapped under screws. Ensure the cable clamp is used to secure the cable. The earth continuity conductor of the electrical installation must be effectively bonded to earth on the fuse board.

CAUTION: Check there are no hidden cables or pipes before drilling holes for wall plugs. Exercise great care when using power tools near water. The use of a residual current device (RCD) is recommended.

IMPORTANT: Turn the Temperature control knob anticlockwise until the valve is fully open before switching on the unit. This will ensure a fast fill up of the unit when the shower is first switched on.

IMPORTANT: The shower unit must be full of water before heat settings are used.

WARNING: If re-starting the shower immediately after stopping, be aware that a slug of hot water will be expelled for the first few seconds.

ATTENTION: Do not operate the shower unit if the showerhead or hose becomes damaged. The shower is designed and approved to EN-60335 with the showerhead provided. Under no circumstances must any showerhead that is not approved by the manufacturer be used with this product.

IMPORTANT: The shower spray head and shower filter **MUST** be cleaned regularly to remove scale and debris. The frequency of cleaning will vary according to local water quality. If the water becomes hot and you are unable to obtain cooler water, immediately check the showerhead and filter for blockage. See section 12 for comprehensive cleaning advice.

USE THE FOLLOWING CHECK LIST TO AID YOUR INSTALLATION

1. Check that the water supply will satisfy requirements
2. Check that water and cable entry points of the unit meet requirements
3. Check that the electric supply will satisfy requirements
4. Positioning of the shower
5. Plumbing installation
6. Electrical installation
7. Fit to the wall and connect the shower supplies
8. Fitting the cover
9. **ONLY Commission the shower in the way described**
10. Familiarise yourself with the user operating instructions

Tick off as you complete

2. IMPORTANT

- Shower Installation must be carried out by a suitably qualified person and conform with IEE Regulations and comply with water regulations, building regulations or any specific local water company regulations and should be in accordance with BS EN 806.
- This shower unit is designed to be connected to a 15mm cold water mains supply. **Do not connect to a tank supply unless a suitable booster pump is fitted.**
- To make sure of activating the heating elements, the shower must be connected to a mains water supply with a minimum running pressure of 100kPa (15 lb/sq in) - (1 Bar) at a minimum flow rate of 8 litres per minute. The maximum static pressure must be no greater than 1000kPa (150 lb/sq in) - (10 Bar). (Minimum running pressure must be obtained at 9 litres/minute for 9.5kW and 11 litres/minute for the 10.5kW).

- The shower unit must not be fitted where it may be exposed to frost, for example in an outdoor area. **The shower must not be used if suspected of being frozen.** Frost damage is not covered by the guarantee.
- **Plumbers jointing compound must not be used.** In instances of difficult joints use P.T.F.E. Tape. The use of compound invalidates the guarantee.
- All plumbing connections must be completed before making the electrical connections.
- The outlet of your shower acts as a vent and must NOT be connected to any form of tap or fitting not recommended by the MX Group.
- Always switch off at the isolating switch when not in use.

3. GENERAL ADVICE TO SHOWER UNIT USERS

The following points will help you to understand how your MX shower unit operates.

The flow rate of water passing through the shower unit determines the water temperature. The lower the flow the warmer the water, the higher the flow the cooler the water.

The temperature produced by the shower unit will vary between seasons on any one setting of the temperature control. This is due to variance in the temperature of the water supply, which becomes cooler in winter than summer.

The stabiliser valve maintains an almost constant shower temperature during mains water pressure changes.

If changes in temperature are experienced in normal use, it is likely to be caused by water pressure falling below the minimum level. Falls in water pressure may be due to water being drawn off at other points within the building.

The showerhead and filter must be cleaned regularly to remove scale and debris. If the water becomes hot and you are unable to obtain cooler water, check the showerhead and filter for blockage.

4. GENERAL LAYOUT OF A SHOWER INSTALLATION

A TYPICAL INSTANTANEOUS ELECTRIC SHOWER INSTALLATION

Plan your own installation carefully. Check on the nearest and most readily accessible rising mains water supply, this may be beneath the bath or in the loft, where it feeds the cold water storage tank. Use only the cold rising water main supply.

Do not connect the shower unit to the outlet from the cold water tank.

Avoid connecting the shower unit, if possible, where it will be affected by water drawn off by other appliances, e.g. From the mains feed to the W.C. This may cause a drop in pressure too low for the shower unit to work correctly.

An isolating valve must be fitted to comply with water regulations and for servicing purposes.

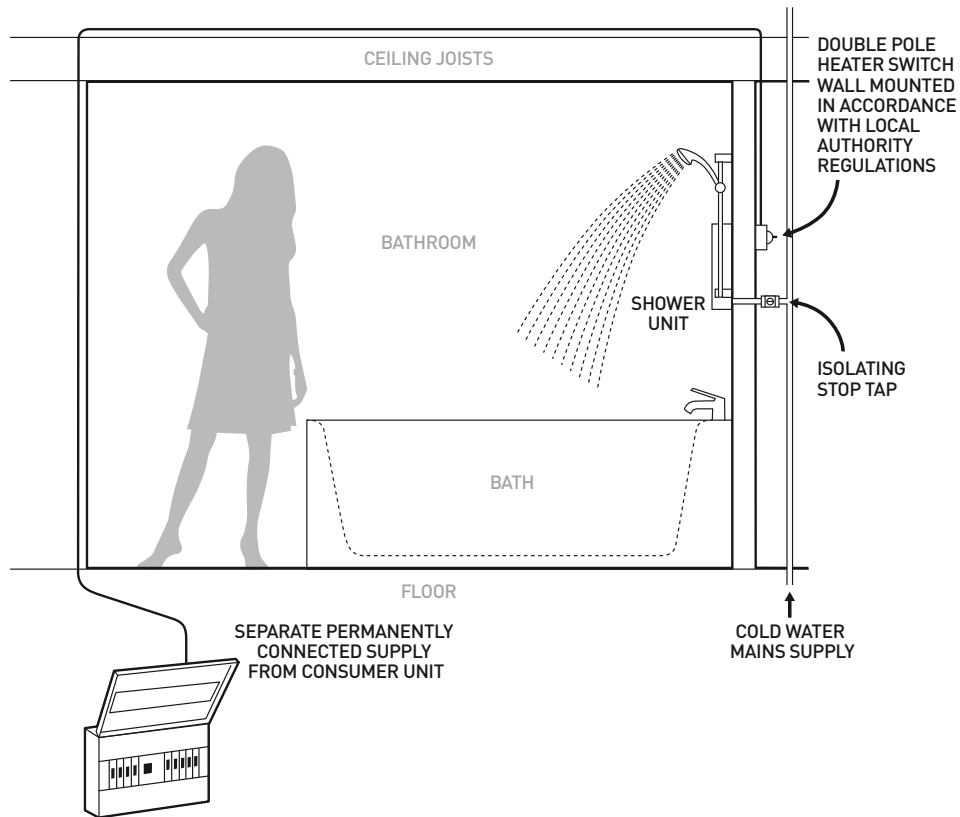

5. INSTALLATION

Position your shower unit on the wall away from the direct spray of the shower and at about the same height as the showerhead position.

The shower unit should be positioned so that the showerhead cannot be immersed in the bath or shower tray when hanging down.

Remove the four screws securing the shower unit cover and remove the cover completely with the control knobs.

Place the shower unit on the wall and mark the location of the fixing screws through the back plate.

Carefully drill the holes as marked using a sharp 5.5mm masonry drill after first having made certain there are no pipes or wires behind the proposed holes.

Fix the shower unit to the wall using the plugs and screws provided, do not fully tighten at this stage.

PRODUCT POSITIONING GUIDE

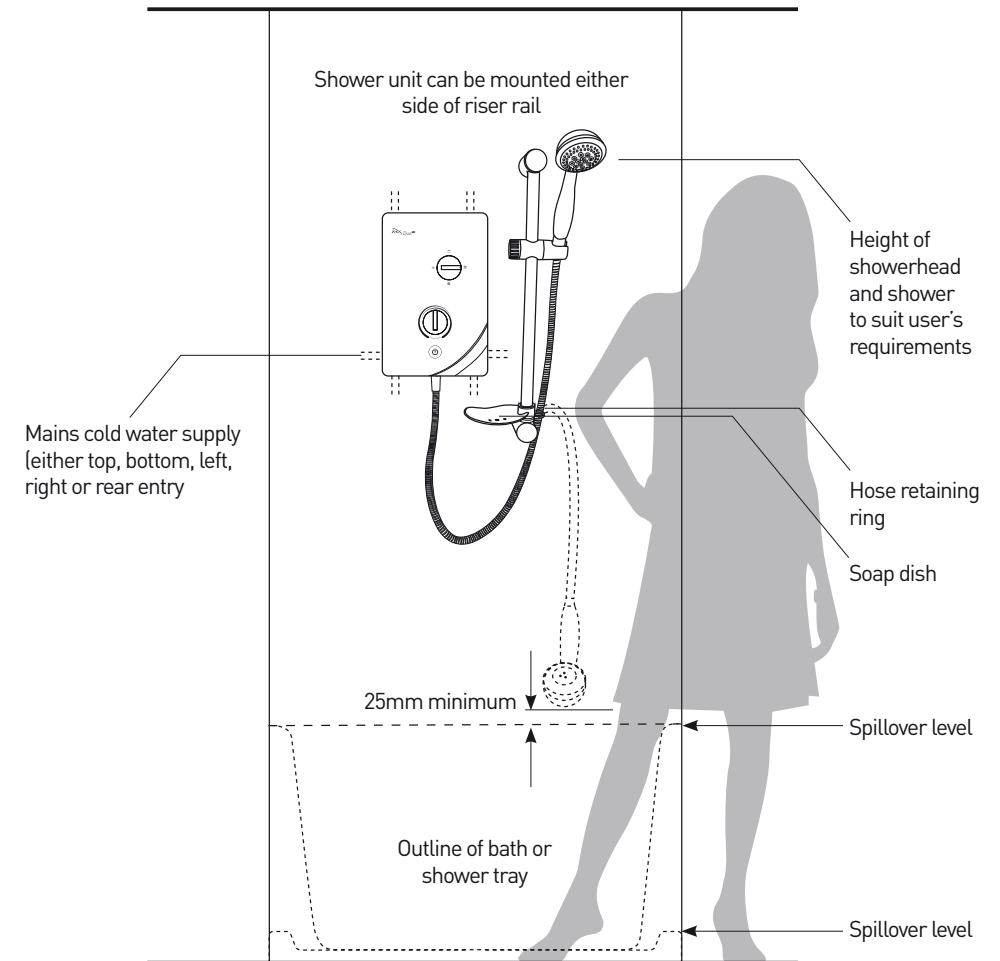

⚠ IMPORTANT ⚠

This appliance is not intended for use by persons (including children) with reduced physical, sensory or mental capabilities, or lack of experience and knowledge, unless they have been given supervision or instruction concerning use of the appliance by a person responsible for their safety. Children should be supervised to ensure that they do not play with the appliance.

6. PLUMBING CONNECTIONS

NOTE!

PLUMBING THE SHOWER UNIT MUST PROCEED WIRING!

QI

QUICK INSTALLATION

As you can see from the diagram right the shower unit can be both plumbed and wired from **8** different positions;

- Top right
- Top left
- Bottom right
- Bottom left
- Right side
- Left side
- Rear right
- Rear left

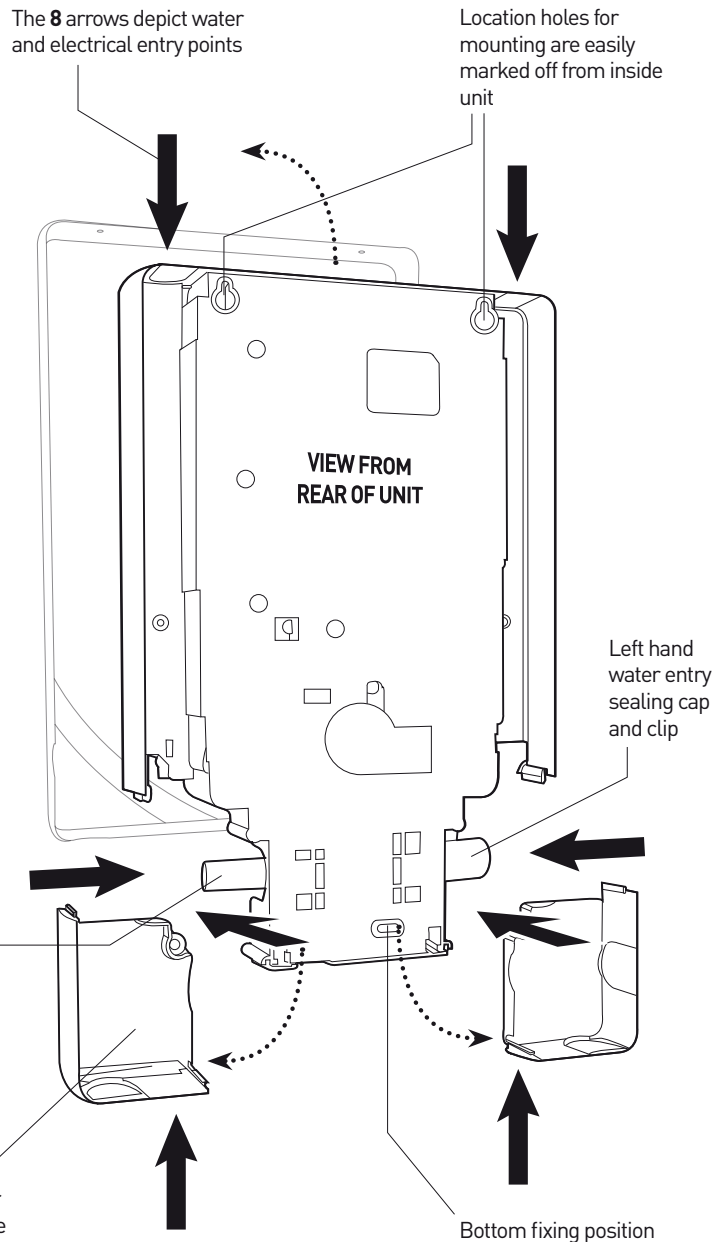

Water inlet, this can be switched with the cap and fixing clip opposite to change water input direction.

See next page for instruction.

Removable cover plates for left or right and bottom inlets, accessible once cover plate is removed. These simply slide into place before replacement of cover.

PLUMBING CONNECTIONS

Water inlet direction option

The shower unit is supplied for right hand installation. To plumb the unit on the left you must:

1. Pull the metal retaining clip out of the blanking end cap with a pair of pliers.
2. Remove the blanking cap - pull off.
3. Simply refit blanking cap to the inlet pipe on the right hand side of the unit.
4. Re-insert the metal fixing clip ensuring it is pushed firmly into the groove.
5. When leak testing the installation you must ensure there are no leaks from this area.

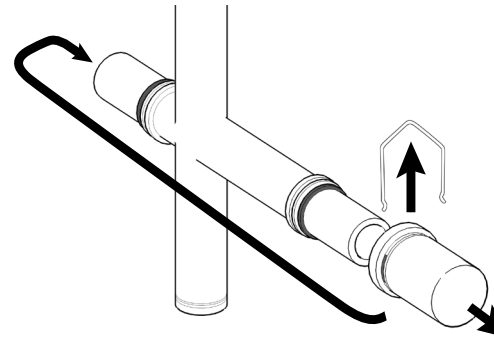

Turn off the water supply at the isolating stop tap. Having determined the direction of the inlet water supply: Top (falling), Bottom (rising), or Back inlets. It is necessary to remove the appropriate plastic cross section from the back plate, before commencing with the installation.

We have incorporated into the bottom right & left hand side of the back plate easy removable trim sections to allow easy access when connecting the water supply.

(Please Note! Remember to replace this trim section before refitting the cover).

Connect the mains water supply to the inlet of the shower unit using a 15mm copper, stainless or plastic pipe with a 15mm compression elbow or 15mm push-fit elbow.

Do not use excessive force when making the connection to the unit.

DEFAULT PLUMBING SETTING

The shower unit is supplied for right hand installation. To plumb the unit on the left you must remove the blanking cap and refit it to the inlet pipe on the right hand side of the unit ensuring the metal fixing clip is pushed firmly into the groove. When leak testing the installation you must ensure there are no leaks from this area.

⚠ IMPORTANT ⚠

To comply with water regulations, building regulations or any specific local water company regulations and should be in accordance with BS EN 806. A double check valve must be fitted with all flexible shower accessories where it is possible that the showerhead may come into contact with used water i.e. In the bath or shower tray.

⚠ IMPORTANT ⚠

Before turning on the water supply to the shower unit the water supply pipe should be flushed out to remove debris. After flushing the pipework ensure that the shower unit is positioned squarely on the wall and tighten the screws. Tighten all plumbing connections and check the pipework for leaks.

7. ELECTRICAL CONNECTIONS

ELECTRICAL SPECIFICATIONS

| Nominal Power rating at 240V | Nominal Power rating at 230V |
|------------------------------|------------------------------|
| 7.5kW - (32A MCB rating) | 6.9kW - (32A MCB rating) |
| 8.5kW - (40A MCB rating) | 7.8kW - (40A MCB rating) |
| 9.5kW - (40A MCB rating) | 8.7kW - (40A MCB rating) |
| 10.5kW - (45A MCB rating) | 9.6kW - (45A MCB rating) |

The shower unit must be permanently connected to the electricity supply, direct from the consumer unit via a double pole linked switch with a minimum contact gap of 3mm. The switch must be readily accessible and clearly identifiable and out of reach of a person using a fixed bath or shower tray, unless the switch is cord operated. The wiring must be connected to the switch without the use of a plug or socket outlet.

The cable size required is determined by the kW rating of the shower and the distance between the shower and the consumer unit. The table below will help you choose the correct cable for your installation, but it will depend upon the precise circumstances of the installation. If you are in any doubt consult an electrician.

The incoming cable should be hidden.

NOTE: the shower contains 2 separate sets of connecting terminal blocks so the shower can be wired for left or right installation with minimum effort. Only connect to one of the terminal blocks.

The diagram below shows the route of the cable into the shower unit for connection to the terminal blocks, connect as follows:

Earth cable to terminal marked \oplus

Neutral cable to terminal marked **N**

Live cable to terminal marked **L**

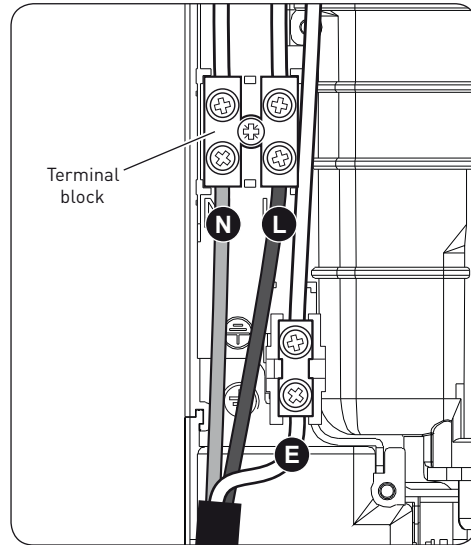

| KW RATING | NOMINAL AT 240V | MIN RATING OF ISOLATING SWITCH | FUSE RATING | MAX CABLE RUN | |
|-----------|-----------------|--------------------------------|-------------|---------------|------|
| | | | | 6mm | 10mm |
| 7.0 | 29.10amps | 30amps | 30amps | 29m | 48m |
| 7.5 | 31.25amps | 40amps | 40amps | 27m | 44m |
| 8.0 | 33.33amps | 40amps | 40amps | 25m | 42m |
| 8.5 | 35.41amps | 40amps | 40amps | 23m | 38m |
| 9.5 | 39.58amps | 40amps | 40amps | 21m | 32m |
| 10.5 | 43.75amps | 45amps | 45amps | 18m | 30m |

IMPORTANT

Ensure that the terminal block screws are fully tightened and that no cable insulation is trapped under screws. Ensure the cable clamp is used to secure the cable. The earth continuity conductor of the electrical installation must be effectively connected to all exposed metal parts of other appliances and services in the room in which the shower unit is installed to confirm

The diagram right shows a schematic wiring diagram.

IMPORTANT: When connecting the cable fully tighten the terminal block screws and make sure that no cable insulation is trapped under the screws. Loose connections can result in cable overheating.

NOTE: The supply cable earth conductor must be sleeved. The outer sheath of the supply cable must be stripped back to the minimum.

The use of connections within the unit or other points in the shower circuit to supply power to other equipment i.e. extractor fans, pumps etc. will invalidate the guarantee.

DO NOT switch on the electricity supply until the shower cover has been fitted.

NOTE: The elements on UK models are to 240V specification and will give a lower kW rating if the voltage supply is below 240V.

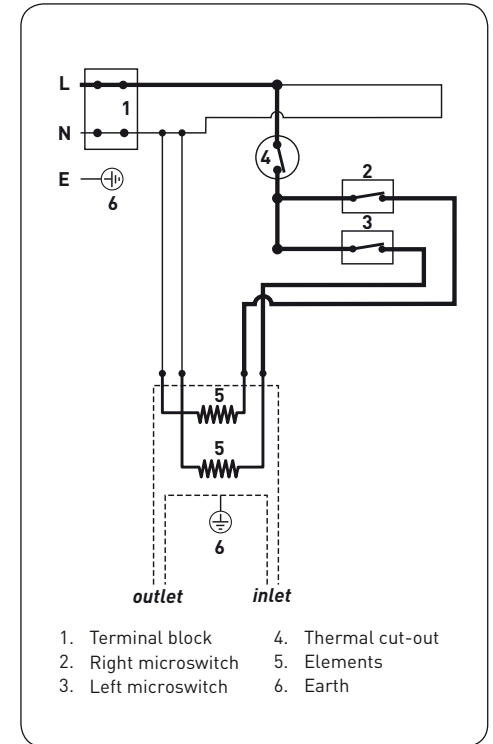

1. Terminal block
2. Right microswitch
3. Left microswitch
4. Thermal cut-out
5. Elements
6. Earth

8. FITTING THE COVER BACK INTO POSITION

NOTE: It is necessary to align the Power Selector and Temperature knobs in the cover with their opposite control spindles before the cover is fitted.

First turn the Power selector knob to the cold position then turn the Temperature knob anti-clockwise to the stop.

Then in the internal unit make sure the Power selector keyway is pointing down and the Temperature spline spindle is rotated fully anti-clockwise until it reaches the stop.

The cover can now be fitted and secured with the four fixing screws provided.

Re-fit the showerhead to the flexible hose. Your shower is now ready to commission.

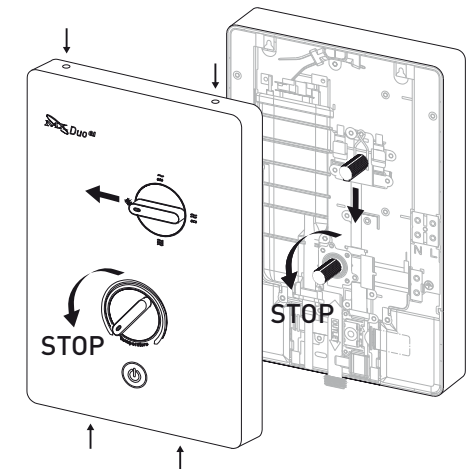

9. RISER RAIL FITTING INSTRUCTIONS

1. Establish position for the riser rail, and mark the wall for the lower mounting bracket. Make allowances for the tallest person likely to use the shower regularly.
2. Remove covers from the wall brackets.
3. Position the lower bracket and mark the wall for the screw fixing. Then drill and plug the wall and the lower bracket without the rail location notch.
4. Fit the rail into the lower bracket. Place the remaining bracket with the rail location notch on top of the rail, making sure that the rail slot is located into the notch. Ensure the hole position is vertically aligned and mark the wall. Remove the rail and bracket, then drill and plug the wall.
5. Slide the height adjuster onto the rail. Tighten to the rail by turning the locking cap. Then fit the soap dish, dampening the rail will make it easier to slide on. Finally fit the hose retaining ring onto the bottom of the rail below the soap dish.
6. Replace the rail assembly into the lower bracket. Refit the top bracket, ensuring the slot in the rail is located into the bracket notch and fix to the wall.
7. Slide covers onto both brackets.

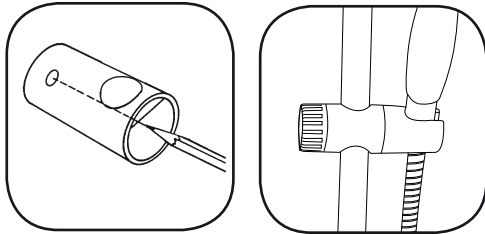
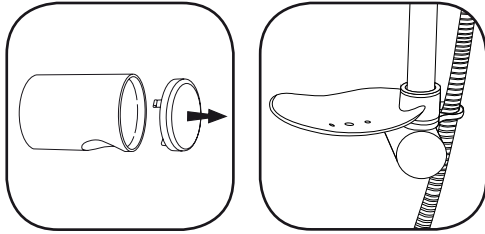
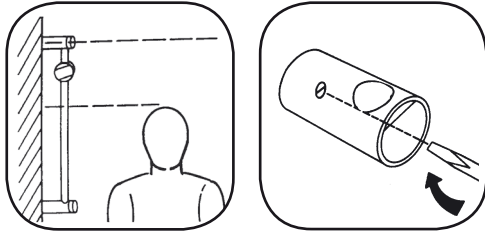

8. Firmly attach flexible hose to showerhead making sure sealing washer is in place after first passing through the hose retaining ring.

NOTE: The adjustable height adjuster grips the conical ends of the hose, not the handle of the showerhead.

TIPS

A piece of insulating or masking tape applied to the wall before marking out the Fixing holes will help stop the drill from wandering, particularly on tiled surfaces. When working near a basin or bath, insert the plug in the waste fitting so that small parts cannot be lost.

Take care not to drop accessories or tools into basin or bath.

CAUTION

Check there are no hidden cables or pipes before drilling holes for wall plugs.
Exercise great care when using power tools near water.
The use of a residual current device (RCD) is recommended.

10. COMMISSIONING THE SHOWER

1. Make sure that the electrical supply has been isolated at the double pole isolating switch.
 2. Turn the top power selector knob to the 'Cold' setting (Solid Blue Symbol).
 3. Turn the bottom temperature control knob anti-clockwise to the full cold position.
 4. Ensuring the water supply is fully on at the mains stop cock and isolating service valve (if fitted), check that water is not leaking from the bottom of the case.
 5. Switch on the electrical supply at the double pole switch. The 'Power' neon indicator will light at switch.
 6. Press the **START/STOP** button. Check that water flows freely from the shower within a few seconds. The water from the showerhead will be at full force and at a cool temperature.
 7. Rotate the bottom temperature control knob slowly clockwise fully. This will gradually reduce the flow with the water temperature remaining cool.
 8. Return the knob anti-clockwise to maximum flow.
 9. Now turn the top power selector knob to the 'Low' setting (Outline Red Symbol). Allow a few seconds for the warmer temperature to reach the showerhead - this shows that the 'ECO' power setting is operating correctly.
 10. Now turn the top power selector knob to the 'High' setting (Solid Red Symbol). The temperature should rise further - this shows that the full power setting is operating correctly.
 11. Turn the bottom temperature control knob clockwise for hotter water and anti-clockwise for cooler water. Allow a few seconds between selections - for the temperature change to reach the showerhead.
- NOTE. When the temperature is changed the flow rate alters.**
12. Push the **START/STOP** button to stop the flow. Turn the power selector knob to the **OFF** position.
 13. Switch off pull-cord or wall mounted switch.
 14. Remove the shower head and make sure no debris has worked into it. Clean and refit.
 15. Remove the filter and clean out any debris from the pipework, clean and refit.

IMPORTANT

Turn the Temperature control knob anticlockwise until the valve is fully open before switching on the unit. This will ensure a fast fill up of the unit when the shower is first switched on.

IMPORTANT

The shower unit must be full of water before heat settings are used.

11. OPERATING THE SHOWER

- Switch on pull-cord or wall mounted switch. The 'Power' neon will illuminate indicating the switch is on.
- Press the **START/STOP** button for immediate water flow. Turn the power selector knob to the desired setting.
- Select your power setting using the top control. The shower has four positions **COLD** ❄️, **ECO 1** ~, **ECO 2** ≈ & **FULL** ≅ power
COLD ❄️ setting:
 Adjustment of the flow control on this setting will only alter the flow of water not the water temperature.
ECO 1 ~ & **ECO 2** ≈ settings:
 This is the low power setting for economy during warmer months or when a cool shower is required. Temperature adjustment is via the bottom temperature control.
FULL ≅ setting:
 This is the full power setting. Temperature adjustment is via the bottom temperature control.
- Wait a few seconds for the warmer water to reach the handset.

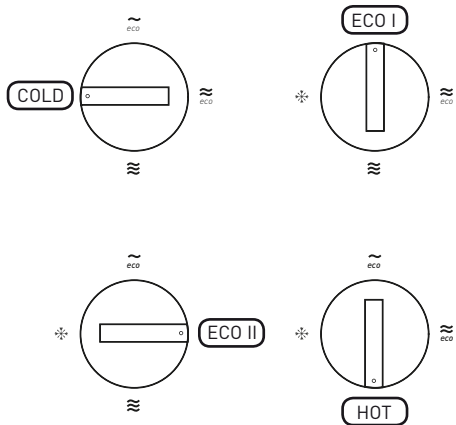

- If necessary turn bottom 'Temperature' control knob slowly to obtain desired showering temperature. Again, waiting a few seconds after each adjustment in temperature to reach the handset.

Note:

To adjust the shower temperature.

The water temperature is altered by increasing or decreasing the flow rate of water through the shower unit via the temperature control.

To increase the shower temperature.

Turn the temperature control knob clockwise, this will decrease the flow of water and increase the shower temperature.

To decrease the shower temperature.

Turn the temperature control knob anti-clockwise, this will increase the flow of water and decrease the shower temperature.

- To turn off the shower unit press the **START/STOP** button.
- A small amount of water will be retained in the showerhead after the shower has been turned off. This may drain over a few minutes.
- Switch of pull-cord or wall mounted switch.

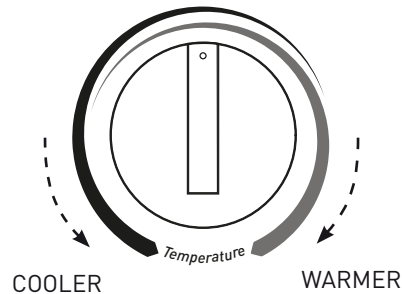

12. SHOWERHEAD CLEANING INSTRUCTIONS

The showerhead should be cleaned periodically to remove limescale or debris which will reduce the performance of the shower. The frequency of cleaning will vary according to local water quality.

PERIODICAL MAINTENANCE

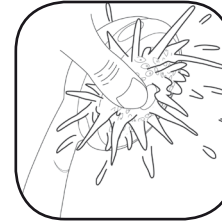

- To break away scale deposits on a daily basis simply rub your thumb over the surface whilst the shower is running.

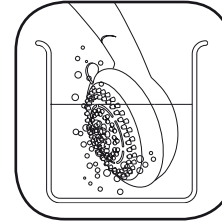

- If scale deposits are stubborn, soak the showerhead in a proprietary limescale remover and rinse thoroughly before use.

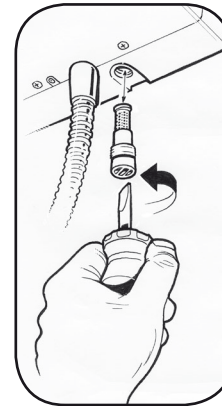

- Remove the filter from the bottom of the shower clean out any debris by washing in clean water. Refit filter.

ATTENTION!

DO NOT OPERATE THE SHOWER UNIT IF THE SHOWERHEAD OR HOSE BECOMES DAMAGED.

THE SHOWER IS DESIGNED AND APPROVED TO EN-60335 WITH THE SHOWERHEAD PROVIDED. UNDER NO CIRCUMSTANCES MUST ANY SHOWERHEAD THAT IS NOT APPROVED BY THE MANUFACTURER BE USED WITH THIS PRODUCT.



WARNING



IF RE-STARTING THE SHOWER IMMEDIATELY AFTER STOPPING, BE AWARE THAT A SLUG OF HOT WATER WILL BE EXPELLED FOR THE FIRST FEW SECONDS.

13. FAQ'S - FREQUENTLY ASKED QUESTIONS

Q. Water does not flow when turned on.

A. Six things to check.

1. Check the mains circuit breaker and /or fuse.
 2. Check the isolation switch in the bathroom.
 3. Check the power from the isolation switch to the unit.
 4. Check the mains water supply.
 5. Check that the valve is open.
 6. Check the inlet filter.
-

Q. Water too cool or cold.

A. Five things to check:

1. Check the power selection setting is on Hot.
2. Confirm there is sufficient water pressure.
3. Clean the showerhead of any dirt and debris, restart the shower on the Hot water setting.
4. Lower the flow of water.
5. Check to see if the auto reset light is permanently on.

If there is still no hot water Contact Customer Care on 0845 5052211.

Q. Water too hot.

A. Six possible reasons:

1. Lower the temperature on the heat dial.
2. Clean the showerhead of any dirt and debris, restart the shower on the Hot water setting.
3. Confirm that the mains water stop valve is fully open.
4. Clean the Inline filter.
5. Ensure the isolation valve is fully open.
6. Try using a lower heat setting.

If there is still no hot water Contact Customer Care on 0845 5052211.

Q. Water is dripping from the bottom of the shower unit.

A. Three possible reasons:

1. The safety pressure relief device may have operated. Remove the showerhead and check that the water flows freely through the hose thus cleaning out the system. Once this has been carried out you will need to fit a new pressure relief device. Contact the service line on 0845 5052211.
 2. Check mains water connections.
 3. Clean the showerhead of any dirt and debris, and if necessary replace the showerhead and hose. Once this has been carried out you will need to fit a new pressure relief device. Contact the service line on 0845 5052211.
-

Q. Water temperature is cycling through hot/cool.

A. Insufficient water flow see installation instructions.

Q. The filter or showerhead keeps blocking or filling up with solid materials.

A. After the initial installation no solid materials should remain in your cold water supply or the electric shower unit. Contact your plumber there is a problem in your water supply.

Q. The shower hose or showerhead is damaged, leaking or otherwise unsatisfactory.

A. Contact Customer Care on 0845 5052211 and they will advise you of a suitable replacement.

Q. My electric shower is out of the warranty period and is no longer working.

A. Contact Customer Care on 0845 5052211 and they will advise you.

Q. Auto reset light comes on if fitted.

A. Temperature in the electric shower has exceeded the safe maximum, then the unit automatically shut down one or both of the elements. When a safe temperature returns the element turns back on.

Q. Power setting will not remain on the setting I have selected.

A. This is a safety feature to reduce the risk of scalding. This is most likely caused by a low water flow check all the solutions in "Water too hot".

Q. Phased shutdown light comes on if fitted.

A. This is a feature of the shower when the power is turned off allowing cold water to flow through the unit for a few seconds to expunge the hot water and to cool the elements.

If the light remains on or comes on when the on off button has not been pressed contact Customer Care on 0845 5052211.

14. THE MARLETON CROSS LTD (MX GROUP) - 2 YEAR GUARANTEE

Marleton Cross Limited (MX Group) hopes you are satisfied with your purchase and in the unlikely event that you encounter a problem which is caused exclusively by the MX Group manufactured product (the "product") we will take responsibility on the terms set out here.

We aim to supply components which have been manufactured to the highest standards. In respect of the product you have a two year guarantee which covers any defect in manufacture.

Any part found to be defective during the guarantee period will be replaced without charge providing that the product has been installed in accordance with our instructions, used as intended and maintained/ serviced as recommended.

In the unlikely event that any problems are encountered with this component's performance on installation, please contact our Customer Care Department for help, as below.

Please supply proof and date of purchase when contacting MX Group.

The company reserves the right, in the event of a claim not covered by the guarantee, to charge the claimant for parts and labour at current rates. This guarantee is given in addition to and does not affect your statutory rights.

Exclusions:

1. Any product found to be defective during this period, as the result of misuse, neglect or damage, will not be covered by this guarantee such as:

- Damage caused by accident
- Those components subject to wear and tear such as 'O' rings and washers etc.
- Effects of scaling
- Damage caused by faulty installation.
- Damage caused by waterborne debris.
- Damage caused by improper cleaning components.
- The components being used for a purpose other than intended.

2. Breakdown due to:

- a) Use other than domestic use by you or your resident family
- b) Wilful act or neglect
- c) Any malfunction resulting from the incorrect use or quality of water or incorrect setting of controls; and
- d) Faulty installation.

3. Repair costs for damage caused by foreign objects of substances or the inappropriate use of jointing compounds or blow torches.

4. Total loss of the product due to non-availability of parts or other reason, (MX Group will maintain stocks of spare parts for repair for at least 5 years from end of product line to cover this guarantee).

5. Compensations for loss of use of the product or consequential loss of any kind.

6. Call out charges

7. The cost of routine maintenance, adjustments, overhaul modifications or loss or damage arising there from, including the cost of repairing damage, breakdown, malfunction caused by corrosion, furring, pipe scaling, limescale, system debris or frost.

8. Components and/or units including components purchased and installed other than in the United Kingdom.

Limitations

1. This guarantee lasts for a single continuous period of 2 years from the date of delivery to you the customer.
2. This guarantee is personal to the original purchaser of the product and is not transferable.
3. Original proof of purchase(s) must be shown for any claim under this guarantee.
4. This guarantee does not cover any components that have been modified, altered or transformed in any way.
5. This guarantee applies to an original installation in accordance to our fitting instructions and does not cover previously installed components (showroom displays etc) or components that have been moved from their original installation position for any reason.
6. This guarantee applies only to manufacturing or material defects. It does not apply to normal wear and tear, accidental damage, inappropriate use (including inappropriate cleaning) or other events outside the manufacturer's control.
7. This guarantee applies only to the product itself and as a result any liability attributed to MX Group is limited to the cost of the component.
8. If a product is deemed to be of faulty manufacture MX Group will at their discretion replace the component. Any related consequential loss or damage is excluded.
9. No claim will be accepted if a product is installed with a fault (ours or otherwise) that would have been clearly evident before installation.
10. We make no representations, and exclude any and all liability, in respect of any third party products or services supplied by way of extensions to this guarantee.

Liability

1. Except as required or agreed by us, you will not in any circumstances return any of the product to us, and where the property in any of the goods returned to us has passed to you, they will nevertheless remain your property and at your risk unless we have agreed otherwise in writing before their return.
2. Except as stated above, we will not be liable for any direct, consequential or other loss, damage or injury suffered or incurred by you, and you will indemnify us fully against any claims made by third parties, in respect of the goods or otherwise arising from the contract.
3. Nothing contained in the contract will be treated as excluding or restricting any liability on our part for death or personal injury resulting from our negligence.
4. Except as stated above, and to the fullest extent permitted by law, all conditions, warranties and representations, whether express or implied, statutory or otherwise in relation to the product (other than such as relate to title to the component) are excluded.
5. You acknowledge that our prices for the goods reflect these Terms and Conditions, and accordingly that you accept the above limitations on and exclusions of liability in exchange for those prices.
6. When providing information to MX-Group you understand that you are doing this subject to our terms and other policies (including data protection) we have in place from time to time, copies of which are available on our website www.mx-group.com or on request as per the MX Group contact details given herein.
7. This guarantee does not affect your statutory rights.

In the interest of continuous product development we reserve the right to alter the specification as necessary.

In the unlikely event that you need to make a claim on our guarantee please contact MX customer care on 0845 505 2211 or sales@mx-group.com

15. SERVICE POLICY

In the event of you needing to contact the MX Group Customer Care Department, the following procedure should be followed:-

1. Before telephoning the MX Group Customer Care Department you should ensure that you have the model number, power rating, serial number, this can be found on the bottom of the shower unit plus the date of purchase.
2. The MX Group Customer Care Department will be able to inform you whether the fault can be rectified by the provision of a replacement part or an on site visit by a Qualified Service Engineer.

3. If a service call is booked, you or a representative must be present during the Engineers visit.

4. A charge will be made where a call under the terms of the guarantee has been booked and a failure was not product related, or an engineer arrives and is not able to gain access.

5. If the product is no longer covered by the Guarantee, a charge will be made for the site visit and for any parts supplied.

Customer Care Department

Telephone: 0845 505 2211 Fax: 0845 850 0757

9.00 am - 5.00 pm Monday to Friday



Marleton Cross Limited Trading as The MX Group

Alpha Close, Delta Drive, Tewkesbury Industrial Estate, Tewkesbury, Gloucestershire GL20 8JF
Tel: 01684 293311 Fax: 01684 293900 Email: sales@mx-group.com www.mx-group.com

CUSTOMER CARE: 0845 5052211

TRADE DESCRIPTIONS ACT

Variations in terms of colour finish, materials and all other aspects of appearance may occur on occasions, either through non-availability of materials or due to our policy of continuing technical improvement. Therefore the Company reserves the right to change specification or withdraw products from this list without prior notice being given.