

Mira Azora
9.8 kW

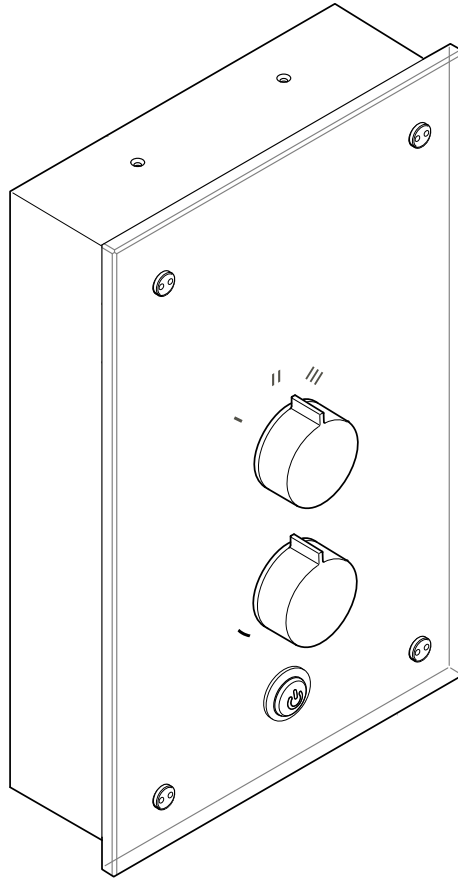

For SPARES,
ADVICE or REPAIRS
please call us free
on 0800 001 4040
(UK only)

Installation and User Guide

These instructions must be left with the user

Showering perfection

mira
SHOWERS

Important Safety Information

WARNING - This shower can deliver scalding temperatures, cause fire, electric shock or other personal injury if not operated, or maintained in accordance with the instructions, warnings and cautions contained in this guide and on the appliance.

Please read the important safety information and the operation section of this guide before using the shower. Failure to follow the instructions provided with this shower will invalidate the guarantee.

TO REDUCE THE RISK OF FIRE, ELECTRIC SHOCK OR INJURY:

1. This appliance can be used by all children and persons with reduced physical, sensory or mental capabilities or lack of experience and knowledge if they have been given supervision or instruction concerning use of the appliance in a safe way and understand the hazards involved.
2. Children shall not be allowed to play with the shower.
3. Cleaning and user maintenance shall not be made by children without supervision.
4. The appliance is not to be used by persons (including children) with reduced physical, sensory or mental capabilities, or lack of experience and knowledge, unless they have been given supervision or instruction.
5. The outlet must not be connected to any tap or fitting other than those specified.
6. The showerhead must be descaled regularly. Any blockage of the showerhead or hose can cause damage to the shower.
7. **Warning!** Do not switch on if there is a possibility that the water in the heater is frozen.
8. The shower must be provided with means for local disconnection from the supply mains having a contact separation in all poles that provide full disconnection under over voltage category III, the instructions state that means for disconnection must be incorporated in the fixed wiring in accordance with the wiring rules.

9. Installation of the shower must be carried out in accordance with these instructions by qualified, competent personnel. Read all instructions before installing the shower.
10. **DO NOT** switch the shower on if water starts leaking from the shower case. Isolate the electrical supply to the shower immediately.
11. **DO NOT** switch the shower on if the case appears to be damaged or incorrectly fitted. Isolate the electrical supply to the shower immediately.
12. **DO NOT** increase the power setting or adjust the temperature control rapidly while using the shower.
13. **DO NOT** switch the shower off and back on while standing in the water flow.
14. **DO NOT** change the handset model. Fit only shower heads recommended by Mira and do not fit any additional device to restrict the water outlet flow.
15. When adjusting the handset mode, point handset away from body and make sure that the water temperature has stabilised before continuing to shower.
16. Use caution when altering the water temperature, always check the temperature before continuing to shower.
17. Switch the shower off at the electrical isolating switch when not in use. This is recommended with all electrical appliances.
18. Installation of the shower must be carried out in accordance with these instructions by qualified, competent personnel. Read all instructions before installing the shower.
19. Isolate the electrical and water supplies before commencing installation. The electricity must be isolated at the consumer unit and the appropriate circuit fuse removed, if applicable. Mains connections are exposed when the cover is removed.
20. **DO NOT** install the shower in areas with high humidity and temperature (i.e. Steam rooms and saunas).
21. **DO NOT** install the shower where it may be exposed to freezing conditions. Ensure that any pipework that could become frozen is properly insulated.

22. **DO NOT** connect the outlet of the shower to any tap, control valve, trigger operated handset or showerhead other than those specified for use with this shower as the outlet acts as a vent for the tank body. Only Kohler Mira recommended accessories should be used.
23. **DO NOT** perform any unspecified modifications, or drill or cut holes in the product other than instructed by this guide. When servicing only use genuine Kohler Mira replacement parts.
24. Always check the water temperature is safe before entering the shower.
25. The water supplies to this product must be isolated if the product is not to be used for a long period of time. If the product or pipework is at risk of freezing during this period they should also be drained of water.
26. If the shower is dismantled during installation or servicing then, upon completion, an inspection must be made to ensure all electrical connections are tight and that there are no leaks.
27. This appliance is intended to be permanently connected to the water mains and not connected by a hose set.
28. Maximum Static Pressure is 1000 kPa (10 bar).
29. Minimum Dynamic Pressure is 70kPa (0.7 bar) 9.8 kW.

Decommissioning and Recycling

When this appliance has reached the end of its serviceable life, it should be disposed of in a safe manner, in accordance with current local authority recycling, or waste disposal policy. For more information about recycling, please contact your local council office.

Pack Contents

Tick the appropriate boxes to familiarize yourself with the part names and to confirm that the parts are included.

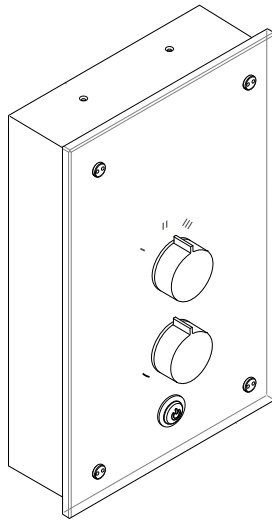

1 x Mira Azora



1 x Olive



1 x Compression Nut

Documentation

1 x Installation and User Guide

1 x Installation Template

1 x Guarantee and Registration Document

Wiring Diagram

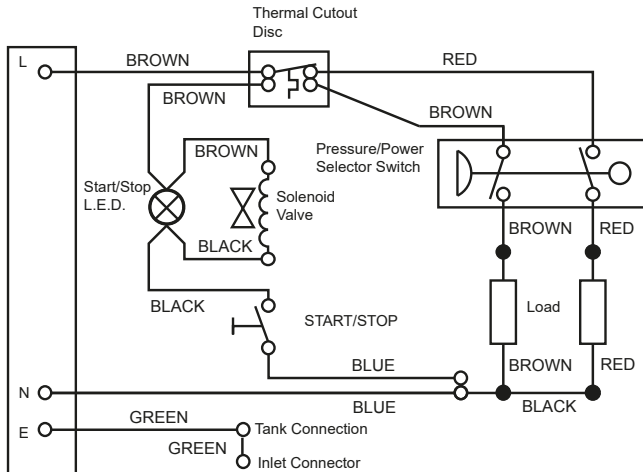

Internal Wiring Diagram

Introduction

Thank you for purchasing a quality Mira product. To enjoy the full potential of your new product, please take time to read this guide thoroughly. Having done so, keep it handy for future reference.

The Mira Azora is a thermostatic electric shower with separate controls for power selection and temperature/flow adjustment. A unique thermostatic valve stabilises temperature changes caused by water pressure fluctuations. These can result from taps being turned on or off, or a toilet being flushed. An individual light indicates “START/STOP”.

Mira Azora 9.8 kW

The Mira Azora comes complete with a set of Mira Energise Shower Fittings.

A 9.8 kW 240 V AC (9.0 kW 230 V AC) heater with Mira Energise adjustable spray handset with four different spray actions (start, soothe, force and eco*). Supplied complete with flexible hose, clamp bracket assembly, slide bar, supports, hose retaining ring and soap dish.

* The ‘eco’ setting will have no effect, and will give the same spray action as the ‘start’ setting.

Mira Electric Showers covered by this guide:

Product	Kw	Model Number	Colour
Azora	9.8	J95L	Frosted Glass
Azora Dual	9.8	J95Lm	

Recommended Usage

Domestic	✓	Light Commercial	✓
Heavy Commercial	✗	Healthcare	✗

Patents and Design Registration

Design Registration:	000578463-001-002
Patents:	GB: 2 341 667, 2 404 000, 2 428 286, 2 427 460 Ireland: 82835, 85128, 85163

Specifications

Plumbing	Variant
	Azora 9.8
Minimum Dynamic Pressure	70 kPa (0.7 bar)
Maximum Dynamic Pressure	500 kPa (5 bar)
Maximum Static Pressure	1000 kPa (10 bar)
Minimum Static Pressure	20 kPa (0.2 bar)
Maximum Inlet Temperature	30°C
Minimum Inlet Temperature	2°C
Inlet Connection	1/2" BSP Male / 15 mm Compression Fitting
Maximum Water Hardness	200 ppm CaCO ₃
Outlet Connection	1/2" BSP Male

Electrical	Variant
	Azora 9.8
Nominal Power at 230 V ac	9.0 kW
Nominal Power at 240 V ac	9.8 kW
Recommended MCB Rating	45 A
Maximum Supply Cable Size	16 mm ²
Recommended RCD Rating	30 mA tripping current
Recommended Isolator Switch	45 A double-pole with 3 mm contact separation
Appliance Sealing Rating	IP X4 - Suitable for installation in Zone 1
Maximum Ambient Temperature	30°C
Minimum Ambient Temperature	2°C

Dimensions	
Height	367 mm
Width	233 mm
Depth	100 mm

Guarantee

For **domestic installations**, Mira Showers guarantee the Mira Azora 9.8 kW against any defect in materials or workmanship for a period of **two** years from the date of purchase (shower fittings for one year).

For **non-domestic installations**, Mira Showers guarantee the Mira Azora 9.8 kW against any defect in materials or workmanship for a period of **one** year from the date of purchase. For terms and conditions refer to section “**Customer Services**”.

European Conformity Information

The Mira Azora shower complies with the following European directives: 2006/95/EC Low Voltage Directive, 2004/108/EC EMC Directive.

The Mira Azora shower is a high power appliance and is subject to conditional connection. If the main electrical supply fuse is rated less than 80 Amps, the local electricity supply company must be contacted to confirm if the electrical supply is adequate.

The Mira Azora shower complies with the requirements of the UK's water regulations.

Installation Requirements

Plumbing

1. The plumbing installation must comply with all national or local water regulations and all relevant building regulations, or any particular regulation or practice specified by the local water supply company.
2. **DO NOT** install the product in a position in which service access is limited.
3. Decide on a suitable position for the shower (minimum distance of 200 mm from the ceiling to allow for cover fit and removal).
4. The position of the shower and shower fittings must provide a minimum gap of 25 mm between the showerhead and the spill over level of any bath, shower tray or basin and a minimum gap of 30 mm between the showerhead and the spill over level of any toilet, bidet or other appliance with a Fluid Category 5 backflow risk (see diagram on page 10).
5. The shower is suitable for installation within the shower area and is fitted with a pressure relief valve. It must be positioned over a water catchment area with the controls at a convenient height for the user.
6. The shower must be fitted to a waterproof flat and even wall surface.
7. **DO NOT** fit the shower to the wall and tile up to the case.
8. **DO NOT** seal the gap between the shower and the wall surface.
9. The showerhead should be positioned so that it discharges down the centre line of the bath or across the opening of a shower cubicle.
10. The showerhead must be directed away from the shower unit, during normal use the showerhead must not spray directly on to the shower unit.
11. **DO NOT** apply excessive force to plumbing connections; always provide mechanical support when making plumbing connections. Any soldered joints should be made before connecting the shower.
12. This shower is not designed to be plumbed directly from the rear. For rear-entry supply, add an elbow to the supply pipe and connect as a rising or a falling supply.
13. If pipework and/or electrical cables enter the shower from the rear through a hole in the wall provision must be made to prevent water ingress back into the wall structure.
14. Only use the inlet connector supplied with the shower. **DO NOT** use any other type of fitting.
15. A full bore/non restrictive servicing valve must be fitted in a readily accessible position adjacent to the shower to facilitate maintenance of the shower.
DO NOT use a valve with a loose washer plate (jumper) as this can lead to a build up of static pressure.

16. A water treatment device should be installed where the water hardness may exceed 200 ppm. Malfunctions caused by excessive limescale formation are not covered by this shower's guarantee (see back page for details).
17. The installation must not cause the hose to be sharply kinked during normal use.
18. **DO NOT** perform the electrical installation until the plumbing has been completed and checked for leaks.

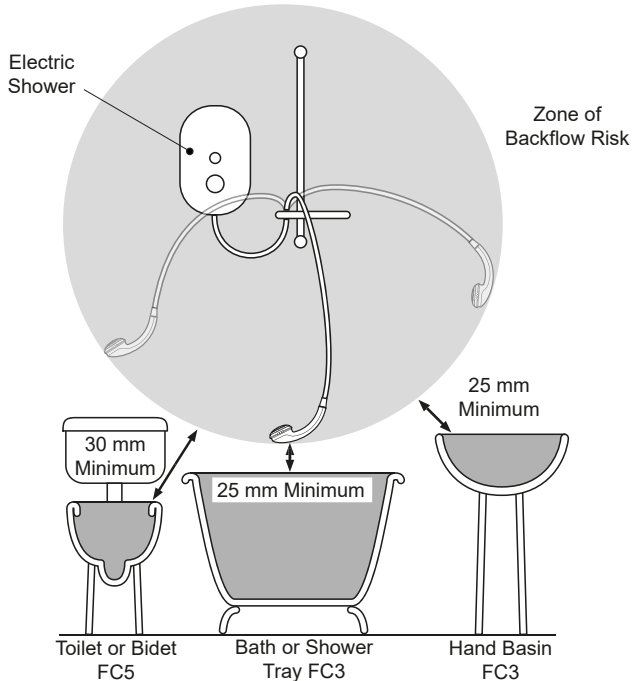

Hose retaining ring fitted and shower fittings fixed at a suitable height preventing dirty water backflow

Note: There will be occasions when the hose retaining ring will not provide a suitable solution for Fluid Category 3 installations, in these instances an outlet double check valve must be fitted, this will increase the required supply pressure typically by 10kPa (0.1 bar). Double check valves fitted in the inlet supply to the appliance cause a pressure build up, which affect the maximum static inlet pressure for the appliance and must not be fitted. For Fluid category 5 double check valves are not suitable.

Electrical

1. The electrical installation must comply with BS 7671 (commonly referred to as the IEE Wiring Regulations) and all relevant building regulations, or any particular regulation or practice specified by the local electricity supply company.
2. Ensure that all circuit protection devices, switches and cabling is adequate for the rated current of the shower and that the rating of the electricity supply company fuse and the consumer unit are adequate for the additional demand.
3. The shower **must** be earthed. Ensure any supplementary bonding complies with the relevant regulations.
4. This shower is intended to be permanently connected to the fixed electrical wiring of the mains system. A separate supply **must** be provided from the consumer unit to the shower.
5. **DO NOT** supply any other electrical equipment including extractor fans or pumps via this product.
6. This shower must be provided with means for local disconnection that is incorporated into the fixed wiring in accordance with the relevant local wiring regulations. This **must** be a double pole switch, which has at least 3 mm contact separation in each pole. The switch can be a ceiling mounted pull-cord type within the shower room or a wall mounted switch fitted in the applicable zone area.
7. A 30mA Residual Current Device (RCD) must be incorporated into the electrical supply to this shower in accordance with wiring regulations.
8. **DO NOT** apply excessive force to the terminal block.
9. All electrical connections should be checked for tightness to prevent overheating before switching on the electrical supply.
10. **DO NOT** switch on the electrical supply until the plumbing has been completed and checked for leaks.

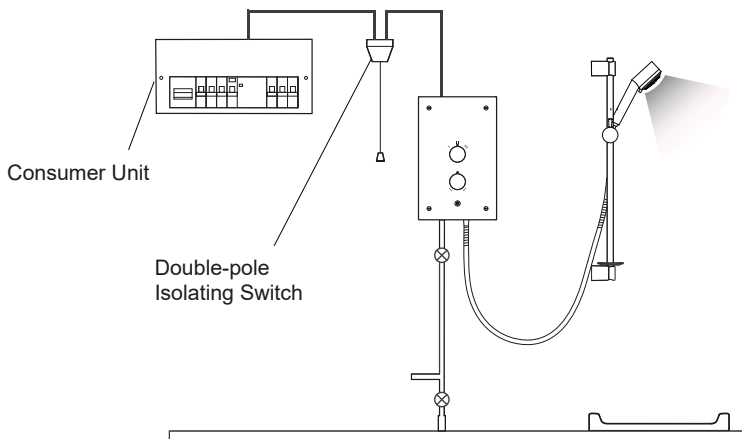

Plumbing and Electrical Schematic

Installation

Installation of Mira Azora

Warning! Turn off the electrical and water supplies before proceeding with the installation of the shower. The electricity must be turned off at the mains and the appropriate circuit fuse removed, if applicable.

Note: An installation template is supplied to help you install the shower.

Wall fixings are not supplied. For solid wall structures a red rawl plug and a no. 8 x 1½" countersunk brass or stainless steel screw should be used. For other wall structures such as panels alternative fixings may be required. A minimum of 3 fixing screws should be used.

Remove the three cover retaining screws, the cover and the service tunnel.

Caution! Handle the glass cover assembly with care.

Determine the direction and route of the incoming water supply: falling (entering the shower from the top), or rising (entering the shower from the bottom).

Note: - DO NOT use an incoming supply entering the shower directly from the back. Add an elbow to the supply pipe and connect it as a rising or falling supply.

Swivel the inlet connector assembly to suit. Remove the inlet blanking cap. Avoid trapping the green earth bonding wire.

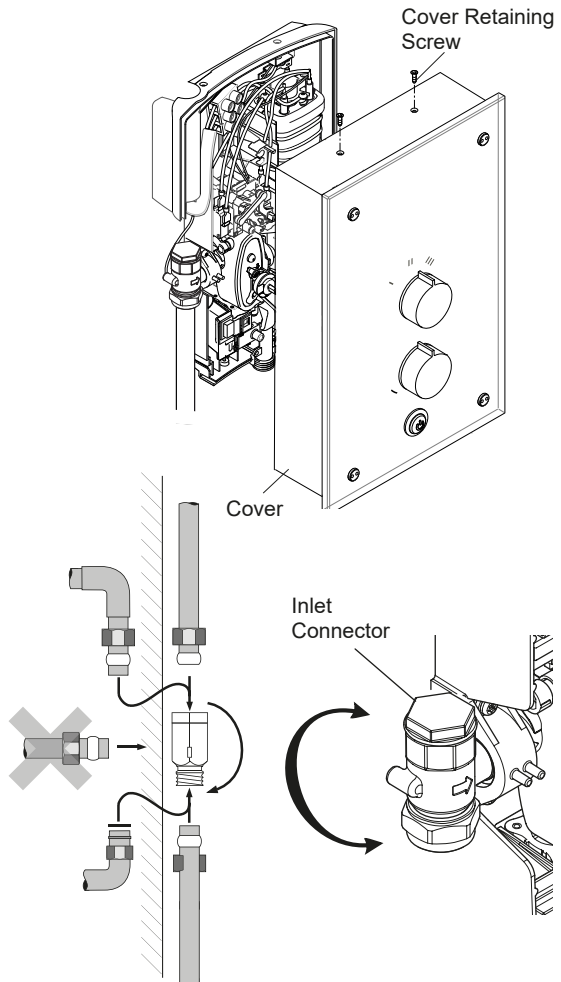

Before fitting the cover, make sure that the appropriate cutouts have been removed to suit the supply entering the product.

Thoroughly flush the mains-fed cold water supply pipe. The supply must be clean and free from debris BEFORE connecting the appliance.

To flush the pipework, turn on the water supply and drain a minimum of 10 litres (2 gallons) of water into a bucket or catchment area. Turn off the water supply.

An installation template is supplied to help you install the Mira Azora.

Put the installation template on the wall and mark through the positions of the fixing holes. Make sure that the position of these holes do not come in line with any buried cables or pipework. Make sure that sufficient electrical supply cable is available for connection to the terminal block.

Drill and plug the top two fixing holes. Secure the appliance to the wall with appropriate screws. Drill the bottom fixing hole with the product in place. Alternative fixings (not supplied) may be necessary for some wall structures. Avoid drilling into any supply cable/pipe.

Install the mains-fed cold water supply pipe. Do not overtighten.
(See Plumbing Installation Requirements).

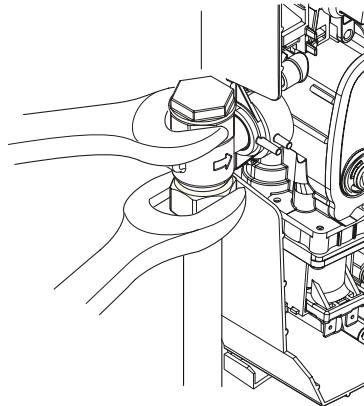

Feed cable into Case. Fit Earth sleeve (not supplied) and strip insulation.
Do not twist cable cores.

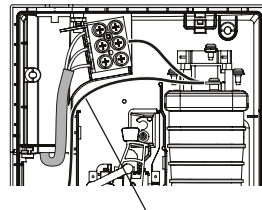

Important! Make sure that the inlet earth wire is routed as shown. Failure to do so may cause product malfunction.

Firmly connect the conductors. Do not exert strain on the terminal block.

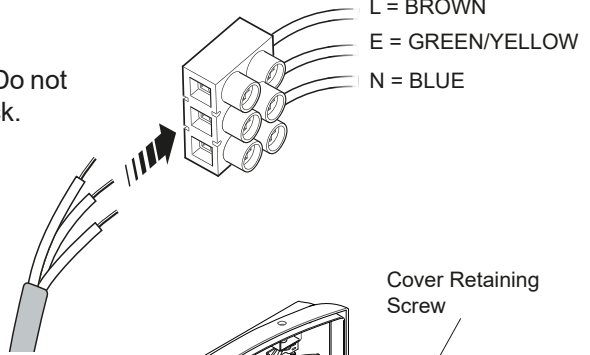

Refit the cover, making sure it is correctly located. Do not overtighten screws.

Caution! Handle the glass cover assembly with care.

Do not use alternative screws to secure the cover. This can cause internal damage to the appliance.
Do not seal around the back of appliance.

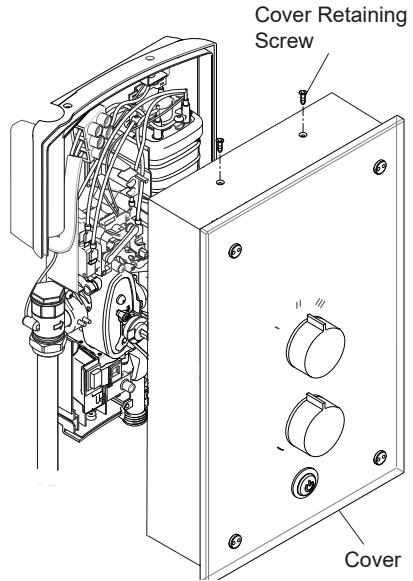

When fitting the cover, position the controls to correspond with the internal drive features as shown.

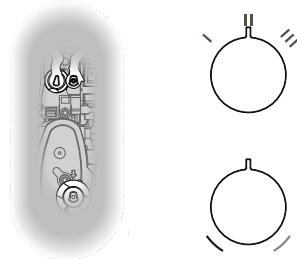

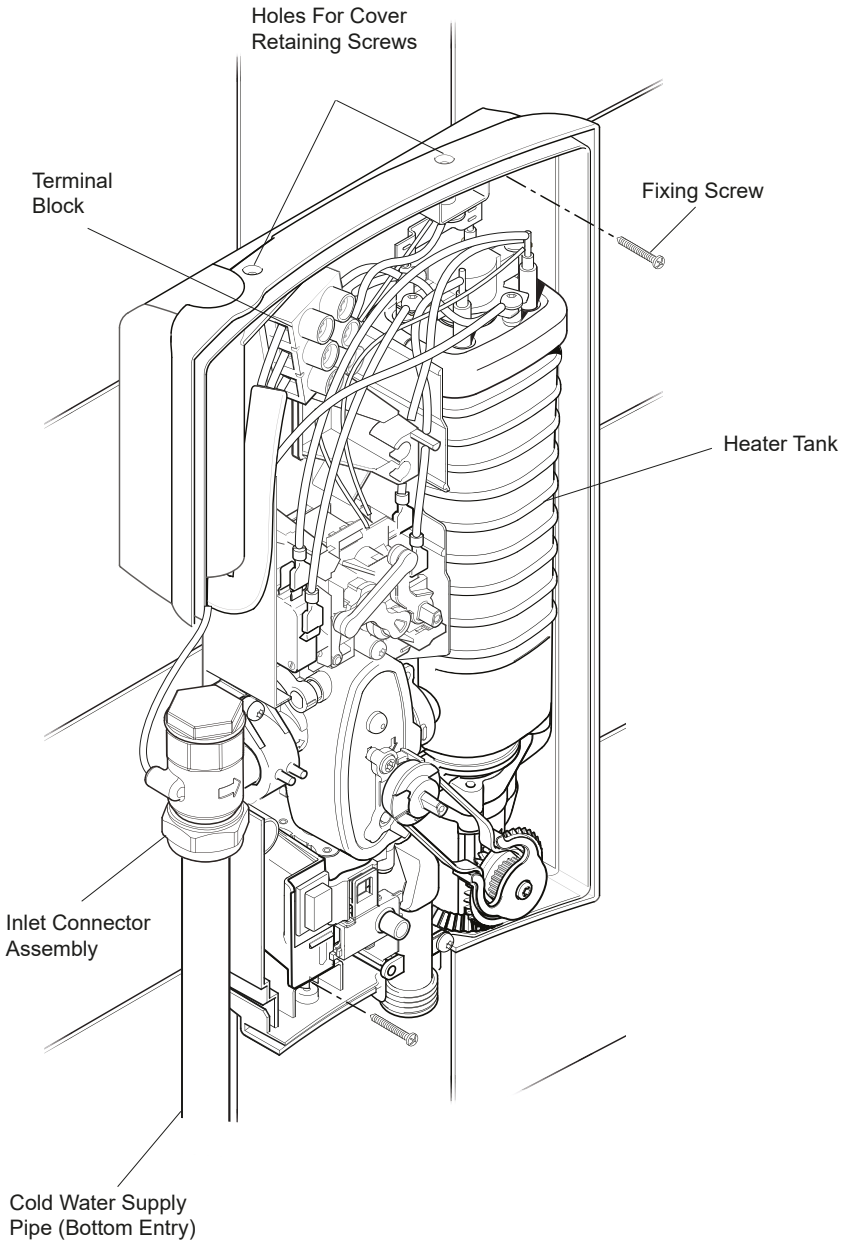

Commissioning

Before carrying out the commissioning procedure install the Shower Fittings, refer to the Shower Fittings Installation and User Guide.

If you are unsure how an electric shower works, please read through the section “User Instructions” before continuing.

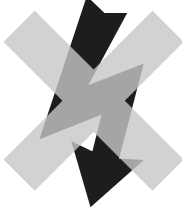
1. 

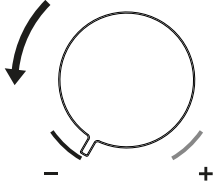
Electrical supply is turned off at the mains.
2. 

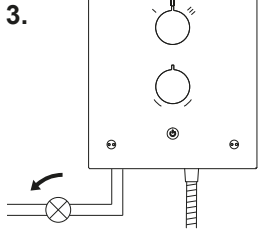
Turn control to full cold.
3. 

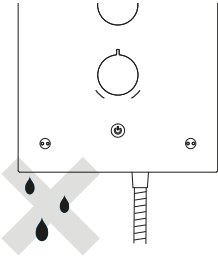
Turn the water supply fully on.
4. 

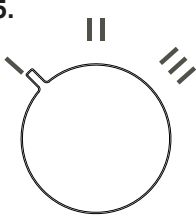
Check for water leaks.
5. 

Set control to 'I'.
6. 

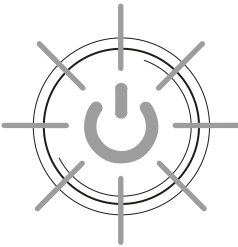
Switch on electrical supply.
7. 

Press the 'Start/Stop' button.
8. 

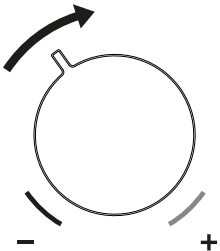
Water will be at full force and at a cool temperature.
9. 

Turn the control slowly. Temperature remains cool and flow is reduced

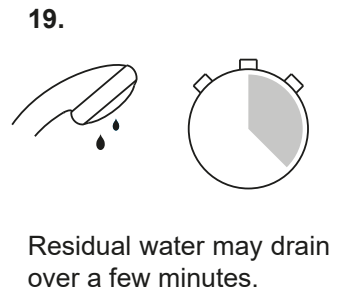
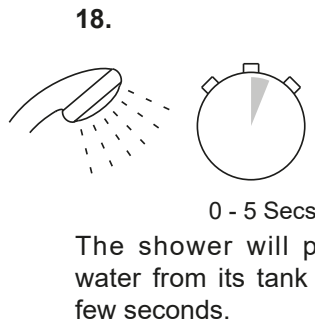
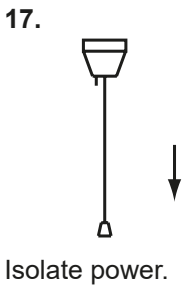
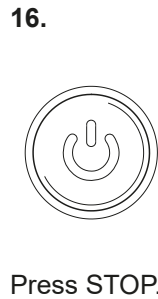
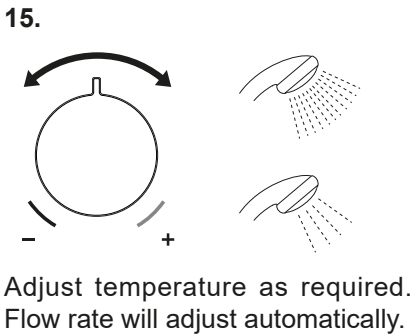
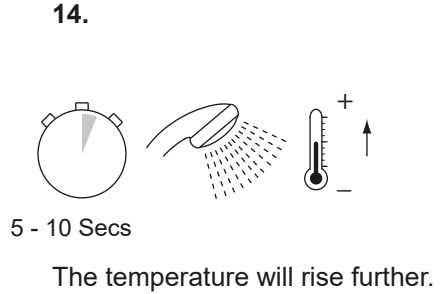
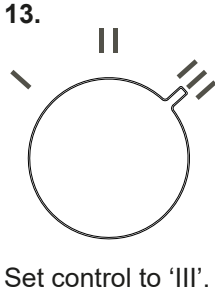
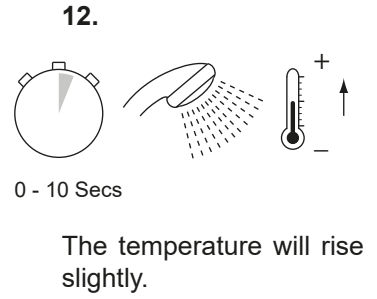
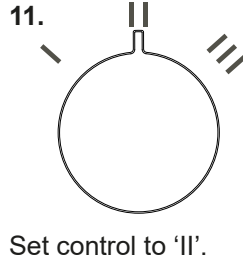
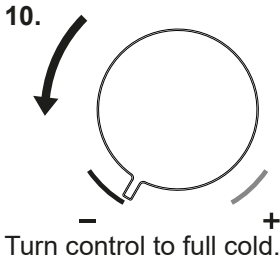

Note: A slight hissing sound may be heard from the Mira Escape during operation. High mains water pressure and high shower temperatures will affect the tone. This is quite normal in use.

User Instructions

How Your Electric Shower Works

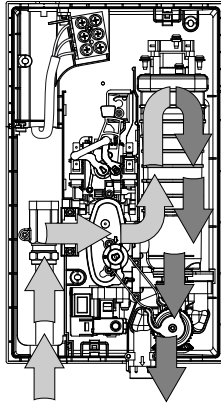

Heated water is produced by adjusting the flow of cold water passed through a heater tank.

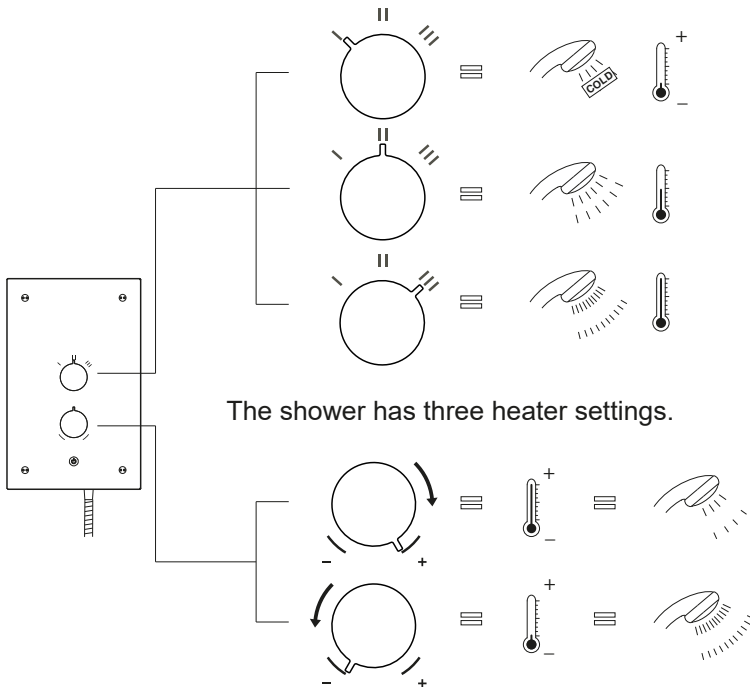

The shower has three heater settings.

The warmer the shower, the lower the flow rate and vice versa.

Thermostatic (Temperature-Stable)

The shower's top priority is to keep the desired water temperature constant. Electric showers with thermostatic control are able to keep a stable temperature across the range from hot to cold, whilst also dealing with fluctuations in electrical and water supplies. As a result, there is a **temperature limit** the shower cannot go beyond. For safety, this temperature is factory set and cannot be adjusted to make the shower hotter or colder.

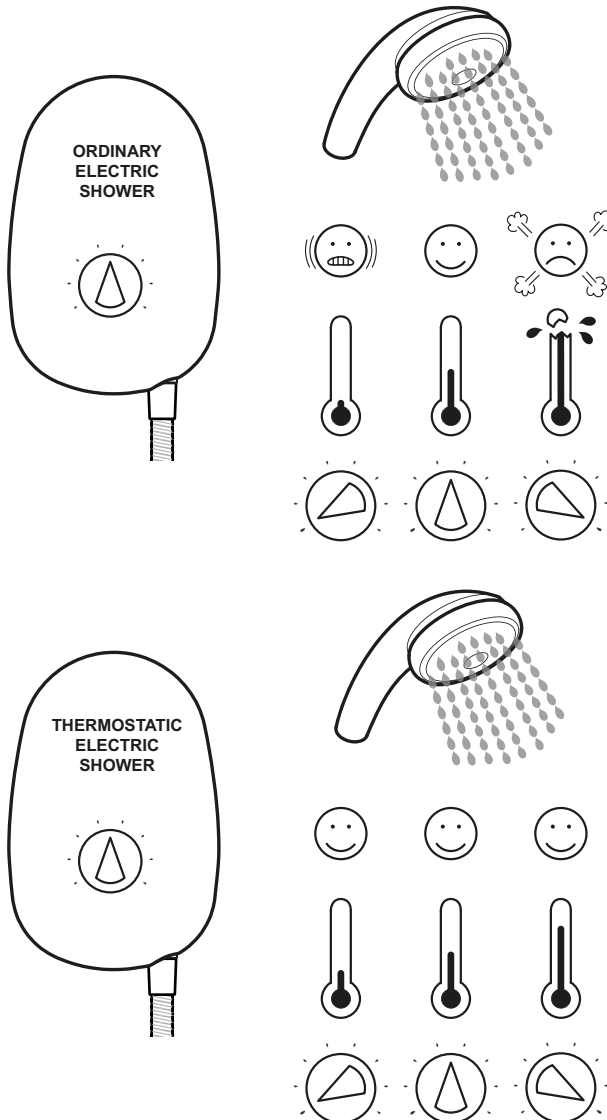

Using your Shower

Read the section "User Safety Information" first.

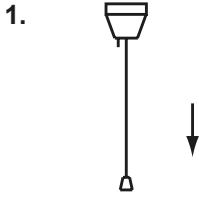

Switch on electrical supply.

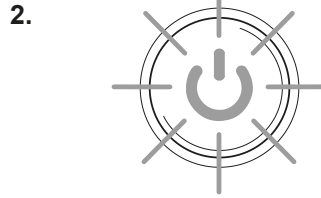

Press the 'Start/Stop' button.

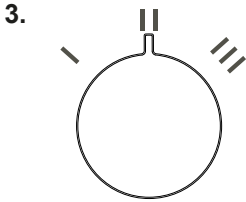

Set to desired position.

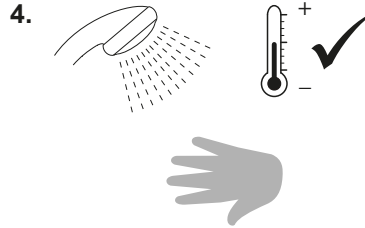

Check water temperature before entering shower.

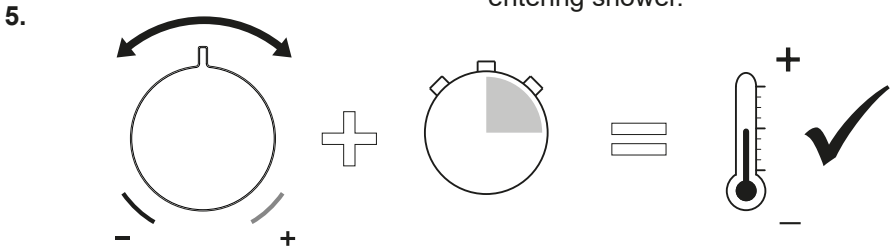

Allow 10 - 15 seconds for any temperature adjustments to reach the handset.

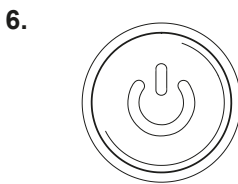

Press STOP button. Shower will continue to run for a few seconds before stopping.

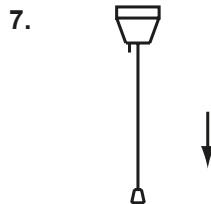

Isolate power.

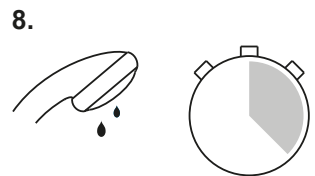

Residual water may drain over a few minutes.

Note: At the end of every shower make sure that the shower head points into the catchment area. A small amount of water may be retained in the shower handset after the shower has been turned off. This may drain over a few minutes.

The Effect of Seasonal Changes

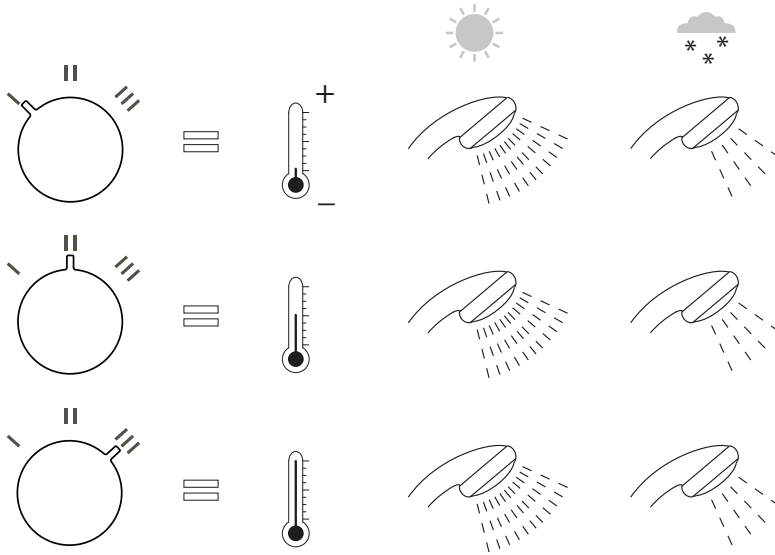

For a cold shower select I.

For a summer warm shower select II.

For a winter warm shower select III.

During extremes of mains water supply temperature, adjust heater setting to obtain a better showering temperature.

The Effect of Other Water Devices

Example of how shower temperature stabilises due to pressure changes.

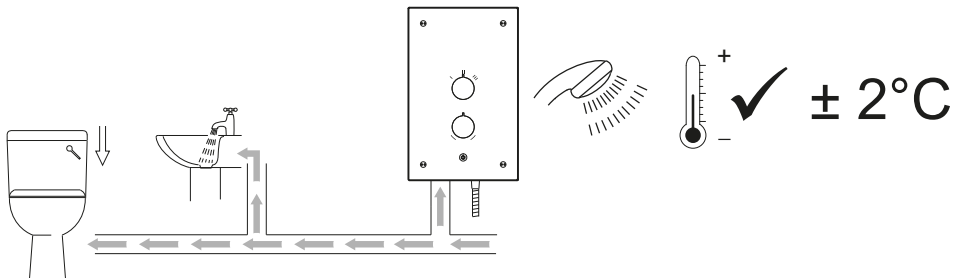

Water inlet pressure fluctuations due to other draw offs (e.g. flushing toilet). Shower temperature will be controlled to within $\pm 2^{\circ}\text{C}$ of the set temperature provided that the supply conditions remain within the required operating parameters (refer to section: '**Specifications**').

Fault Diagnosis

The trouble shooting information tabled below gives details on probable causes and remedies should difficulties be encountered whilst the shower is in operation.

Warning! There are no user serviceable components beneath the cover of the appliance. **Only a competent tradesperson should remove the front cover!**

Symptom	Start/ Stop Light	Heater Setting I / II / III	Probable Cause	Possible Remedy
Appliance Fails to operate	OFF	ANY	Electrical supply isolated at double pole switch.	Switch on electrical supply via the pullcord or wall mounted switch.
			Fuse blown or MCB/RCD tripped, indicating possible electrical fault.	Renew the fuse or reset the MCB/RCD. If fault persists, contact your installer.
Shower cycles from hot to cold	ON	II / III	Showerhead blocked	Remove and clean.
			Water pressure below minimum required for appliance operation.	Make sure incoming mains water stopcock and/or appliance isolating valve is fully turned on.
			Temperature dial or Heater setting too high.	Turn the heater selector knob to setting II or turn the temperature control until a cooler temperature is achieved.
			Thermostatic mechanism is faulty or damaged.	Replace.
Unable to select a cool enough shower.	ON	III	Due to the rise in mains water supply temperature, the Heater setting may be too high.	Turn the heater selector knob to II and adjust the temperature control until a suitable temperature is achieved.
Unable to select a hot enough shower (cold only)	ON	I / II	Power control not on high	Turn the power control to high
	ON	ANY	Temperature control on cool setting	Turn the temperature control until a hotter temperature is achieved
			Water pressure below minimum requirement for shower operation	Make sure incoming mains water stopcock and / or shower isolating valve is fully open Contact water company
			Showerhead blocked	Remove and descale showerhead
			Hose kinked or blocked	Check hose and replace if necessary, see section - 'USER MAINTENANCE' .
Restriction in Showerhead mode	Select different Showerhead mode			

Symptom	Start/ Stop Light	Heater Setting I / II / III	Probable Cause	Possible Remedy
Hand set dripping	OFF	ANY	Insufficient water supply pressure for shut off.	The minimum static pressure to ensure shut off and prevent dripping is 0.2 bar. Note! If other appliances are operating, static pressure may drop below 0.2 bar. Contact local water company. Renew the Flow Valve.
			Inlet valve faulty	Replace
Low or no flow.	ON	ANY	Water supply pipework or inlet filter restricted by a blockage or partial blockage.	Flush supply pipe. Clean inlet filter.
			Insufficient water supply pressure/flow for operation.	Contact local water company. Supply pressure must be a minimum of 0.7 bar. Note: If other appliances are operating, pressure may drop below 0.7 bar.
			Other outlets (e.g. toilet, garden hose, washing machine, etc.) drawing water while the shower is being used.	Turn off other appliances whilst shower is in use.
			Showerhead blocked.	Remove and clean.
	OFF	ANY	Service tunnel or cover not fitted correctly causing Start/ Stop button not to operate.	Check case inserts are cut and fitted correctly. Check services (electrical or plumbing) are not interfering with location of service tunnel or cover.
	ON	ANY	Inlet Valve faulty.	Replace.
			Heater Tank excessively scaled.	Replace. In hard water areas consider the use of a water softener.
Operation of temperature control has little or no effect on water temperature.	ON	II / III	Showerhead or inlet filter blocked.	Remove and clean.
			Inlet valve faulty.	Replace.
			Heater tank failure.	Replace.
			Microswitch failure.	Replace.

Symptom	Start/ Stop Light	Heater Setting I / II / III	Probable Cause	Possible Remedy
No change in temperature between I/II/III settings.	ON	ANY	Insufficient mains water pressure.	Contact local water company.
			Possible failure of flow valve, microswitch or heater tank.	Check the continuity of the microswitch or heater tank and replace parts as necessary.
Water will not turn off.	ON	ANY	Inlet valve, solenoid, or start/stop switch faulty.	Replace as necessary.
			Supply pressure below 0.2 bar.	Contact local water company. Check mains water static pressure.
Appliance fails to produce hot water when set on II/III heater settings.	ON	II / III	Insufficient water supply	Contact local water company.
			Possible failure of the microswitch or thermal switch.	Check the continuity of the microswitch or heater tank and replace parts as necessary.
			Heater Tank failure.	Replace.

User Maintenance

- There are no user serviceable parts inside the shower. Only qualified, competent personnel should remove the front cover, mains connections are exposed when the cover is removed.
- Switch the shower off at the isolator switch before performing any user maintenance or before cleaning the shower.
- **DO NOT** allow young children to perform user maintenance including cleaning of the shower.
- **DO NOT** use the showerhead to clean the shower.
- If the shower is not to be used for a long period, the electrical supply and water supply to the shower should be isolated. If the shower or pipework is at risk of freezing during this period a qualified, competent person should drain them of water.

Cleaning

Many household cleaners contain abrasives and chemical substances, and should not be used for cleaning plated or plastic parts or fittings. These finishes should be cleaned with a mild washing up detergent or soap solution, and then wiped dry using a soft cloth.

De-scaling the Showerhead

Important! Keeping the showerhead clean and free from limescale will ensure that your shower and showerhead continue to perform to their maximum. A blocked showerhead can restrict the flow rate and may cause damage to your shower.

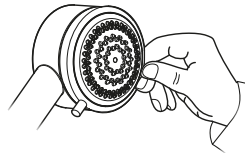

Use your thumb or a soft cloth to wipe any limescale from the soft nozzles

Inspecting the hose

Important! The shower hose should be inspected periodically for damage or internal collapse, internal collapse can restrict the flow rate from the showerhead and may cause damage to the shower. Remove the shower hose from the shower, inspect and replace the hose if necessary.

Unscrew the hose from the showerhead and the shower outlet.

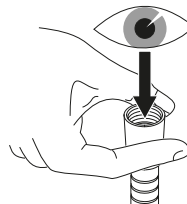
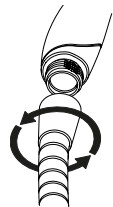

Inspect the hose.

Servicing

Warning! There are no user serviceable parts inside the shower. Servicing of the shower must only be carried out by qualified, competent personnel following the instructions provided in this guide and those provided with any spare part. Before replacing any parts, ensure that the underlying cause of the malfunction has been resolved.

Inlet Filter - Cleaning/Renewing

Read the section “**Important Safety Information**” first

Make sure that the electrical supply is turned off at the mains and that the water supply is fully turned off.

Remove the three screws and the cover.

Caution! Handle the glass cover assembly with care.

Hold a wrench across the flats of the metal connector. Unscrew the filter using another wrench as shown. Clean or renew the Filter as necessary. Refit in reverse order making sure the Filter is screwed fully home.

Do not overtighten! Make sure plumbing connections are sealed before restoring electricity supply.

Refit the cover making sure it is correctly located. Do not overtighten the screws.

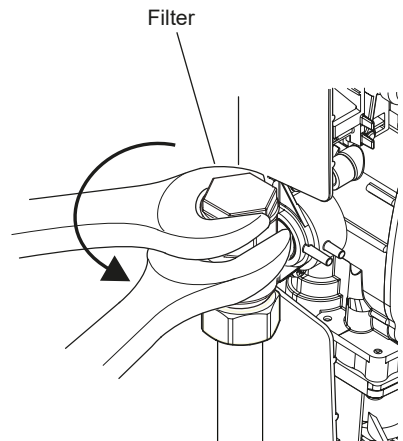
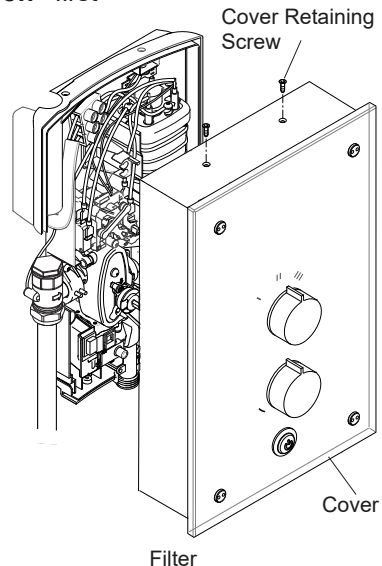

Spare Parts

416.38	Clamp Bracket (Inlet)	1634.026	Screw Pack - components identified 'A'
416.41	Thermal Switch	1623.009	Cover Assembly - Frosted Glass
416.48	Latching Switch	1634.118	Cover Assembly - Blue Glass
416.51	Solenoid Coil	1634.119	Cover Assembly - Grape Glass
1563.519	Terminal Block Assembly	1634.120	Cover Assembly - White Flock Glass
1563.845	Thermostatic Valve/Heater Tank 9.8 kW 240 V AC (includes microswitches)	1634.121	Cover Assembly - Stripes
1563.534	Outlet Connector Assembly	1634.122	Cover Assembly - Flag
1563.537	Temperature Control Belt Thermostatic	1634.123	Cover Assembly - Stones
1563.538	Temperature Cam & Pulley	1634.124	Cover Assembly - Dots
1563.539	Switching Assembly	1829.062	Inlet Filter (with 'O' seal fitted)
1563.540	Inlet Valve Assembly	1829.063	Inlet Connector Assembly
1563.551	Component Pack - chrome - components identified 'B'		
1634.015	Start/Stop LED Assembly		

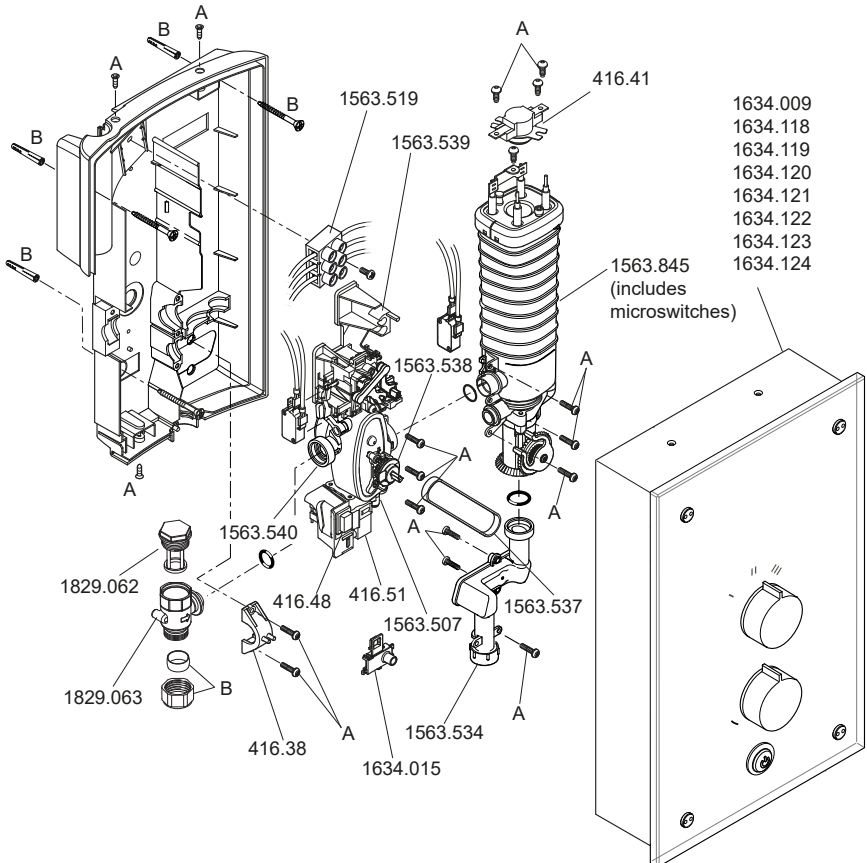

Customer Support

Guarantee

Your product has the benefit of our manufacture's guarantee which starts from date of purchase. This guarantee only applies in the United Kingdom and Republic of Ireland. To activate this guarantee, please return your completed registration card, visit our website or free phone 0800 5978551 within 30 days of purchase (UK only).

Within the guarantee period we will resolve defects in materials or workmanship, free of charge, by repairing or replacing parts or product as we may choose.

This guarantee is in addition to your statutory rights and is subject to the following conditions :

- The guarantee applies solely to the original installation under normal use and to the original purchaser only. The product must be installed and maintained in accordance with the instructions given in this guide.
- Servicing must only be undertaken by us or our appointed representative.
Note! If a service visit is required the product must be fully installed and connected to services.
- Repair under this guarantee does not extend the original expiry date. The guarantee on any replacement parts or product ends at the original expiry date.
- For shower fittings or consumable items we reserve the right to supply replacement parts only.

The guarantee does not cover:

- Call out charges for non product faults (such as damage or performance issues arising from incorrect installation, improper use, inappropriate cleaning, lack of maintenance, build up of limescale, frost damage, chemical attack, corrosion, system debris or blocked filters) or where no fault has been found with the product.
- Water or electrical supply, waste and isolation issues.
- Compensation for loss of use of the product or consequential or indirect loss of any kind.
- Damage or defects caused if the product is repaired or modified by persons not authorised by us or our appointed representative.
- Routine maintenance or replacement parts to repaired or modified by persons not authorised by comply with the requirements of the TMV2 or repaired or modified by persons not authorised by TMV3 healthcare schemes
- Accidental or wilful damage.
- Products purchased ex-showroom display.

What to do if something goes wrong

If your product does not work correctly refer to this manual for fault diagnosis and check that it is installed and commissioned in accordance with our instructions. If this does not resolve the issue, contact us for help and advice.



Helpdesk Service

Contact our Customer Services Team for product advice, to purchase spare parts or accessories or to set up service visit. You can contact us via phone or e-mail - contact details below.

Please provide your model name, power rating (if applicable) and date of purchase.



Mira Showers Website

(www.mirashowers.co.uk)

Visit our website to register your guarantee, download user guides, diagnose faults, purchase our full range of accessories and popular spares, or request a service visit.



Spares and Accessories

We hold the largest stocks of genuine Mira spares and accessories. Contact us for a price or visit our website to purchase items from our accessory range and popular spares. (Only available in the United Kingdom)



Service/Repairs

No one knows our products better than our nationwide team of Service Technicians. We can carry out service or repair work to your product both during and after the guarantee period. (Only available in the United Kingdom and Republic of Ireland) Ask about our fixed price service repairs.

To Contact Us: UK



0800 001 4040



Fax: 01242 282595



Email – Visit

www.mirashowers.co.uk/contactus



By Post: **Mira Customer Services Dept, Cromwell Road, Cheltenham, Gloucestershire GL52 5EP**

To Contact Us: Eire Only



01 531 9337



E-mail:

CustomerServiceEire@mirashowers.com

Mira is a registered trade mark of Kohler Mira Limited.

The company reserves the right to alter product specifications without notice.



mira
SHOWERS

Check out our full range of Showers

Electric Showers

Digital Showers

Mixer Showers

Power Showers

Smart Showers

Shower Towers

From Top Shower Brands

Mira Showers

Aqualisa Showers

Triton Showers

Gainsborough Showers

Shower Pumps can upgrade your showering experience even more

Stuart Turner Shower Pumps

Salamander Shower Pumps

Grundfos Shower Pumps

plumbworld
Big brands, small prices.