

9.0 kW

mira

Advance
ATLP THERMOSTATIC

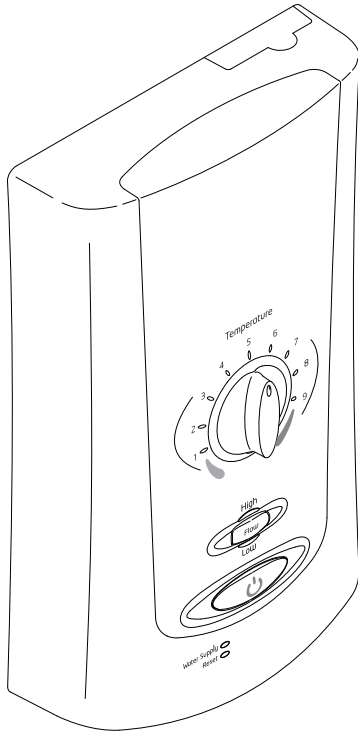

**MIRA ADVANCE ATLP
LOW PRESSURE**
ADJUSTABLE TEMPERATURE LIMIT THERMOSTATIC

**PUMPED ELECTRIC
SHOWER**

Installation Guide

**This product is suitable for gravity cold water only.
Please leave these instructions at the installation address.**

CONTENTS

Shower Models	3
Guarantee	3
Patents and Design Registration.....	3
Important Safety Information	4
Pack Contents	6
Specifications	7
Standards and Approvals	7
Dimensions.....	8
Installation Requirements	9
General.....	9
1. Plumbing	9
Pipework	11
Plumbing Schematic Diagram.....	11
2. Electrical.....	12
Electrical Schematic Diagram	12
Installation	14
Commissioning	18
Set Maximum Temperature and Commissioning Cycle.....	18
BEAB Care	19
Maintenance	20
Fault Diagnosis	20
1. Installer Troubleshooting Guide.....	20
2. Diagnostic Procedure	21
Error Code Table	22
BEAB Care In-Service Tests	25
Spare Parts	27
Wiring Diagram	29
Accessories	30
BEAB Care In-Service Test Record	31
Back Cover	32

If you experience any difficulty with the installation or operation of your new Pumped Electric Shower, then please refer to '**Fault Diagnosis**', before contacting Mira Showers. Our contact details can be found on the back cover of this guide.

SHOWER MODELS

Mira Advance Low Pressure models covered by this guide

Product Variant	Adjustable Temperature Limit	Extended Lever Control	Model No.
Standard 9.0 kW	✓	✘	J97I
Flex 9.0 kW	✓	✓	J97K

Guarantee

For **domestic installations**, Mira Showers guarantee the Mira Advance ATLP against any defect in materials or workmanship for a period of **two years** from the date of purchase (shower fittings for one year).

For **non-domestic installations**, Mira Showers guarantee the Mira Advance ATLP against any defect in materials or workmanship for a period of **one year** from the date of purchase.

For Terms and Conditions refer to the back cover of this guide.

Recommended Usage	
Domestic	✓
Light Commercial	✓
Heavy Commercial	✘
Healthcare	✓

Patents and Design Registration

Design Registration:	000738141: 0003, 0006, 0007, 0009
Patents:	GB: 2269466, 2270370, 2298478, 2298479, 2298481, 2289323, 2359339. Ireland: 80655, 83692.

IMPORTANT SAFETY INFORMATION

Installation must be carried out in accordance with these instructions, and must be conducted by designated, qualified and competent personnel.

WARNING!

Follow all warnings, cautions and instructions contained in this guide, and on or inside the shower.

- 1. This shower can deliver scalding temperatures if not operated, installed or maintained in accordance with the instructions, warnings and cautions contained in this guide and on or inside the appliance.**
- Products manufactured by us are safe and risk-free, provided that they are installed, used and maintained in good working order, in accordance with our instructions and recommendations.
- This product is suitable for installation within Zone 1 and is rated IPX4.
- Isolate the electrical and water supplies before commencing installation. The electricity must be turned off at the mains and the appropriate circuit fuse removed, if applicable.
- Mains connections are exposed when the cover is removed.
- Refer to the wiring diagram before making any electrical connections.
- Make sure all electrical connections are tight, to prevent overheating.
- Make sure that any pipework that could become frozen is properly insulated. The shower unit must not be fitted where it may be exposed to freezing conditions.
- The water supplies to this product must be isolated if the product is not to be used for a long period of time. If the product or pipework is at risk of freezing during this period they should also be drained of water.
- DO NOT** operate this appliance if it is frozen. Isolate the electrical supply and allow to thaw. Check for leaks before reconnecting the electrical supply.
- DO NOT** install the product in a position in which service access is restricted.
- If the shower is dismantled during installation or servicing then upon completion the product must be inspected to ensure there are no leaks.
- DO NOT** fit any form of outlet flow control (e.g. trigger handsets) as the outlet acts as a vent for the tank body. Only Mira recommended outlet fittings should be used.
- This product is not suitable for areas with high humidity (i.e. steam rooms).
- THIS APPLIANCE MUST BE EARTHED. MAKE SURE SUPPLEMENTARY BONDING COMPLIES WITH THE 'REQUIREMENTS FOR ELECTRICAL INSTALLATIONS' BS7671.** This pumped electric shower is intended to be permanently connected to the fixed electrical wiring of the mains system.
- This appliance must be provided with means for disconnection that is incorporated into the fixed wiring in accordance with the relevant local wiring regulations.
- This appliance is suitable for installation within the shower area. It must be

positioned over a water catchment area with the controls at a convenient height for the user. The shower fitting should be positioned so that it discharges down the centre line of the bath, or across the opening of a shower cubicle, and **must be directed away from the appliance.**

CAUTION!

1. Read all of these instructions and retain this guide for later use.
2. The electrical installation must comply to 'BS 7671 (commonly referred to as the IEE Wiring Regulations) and all relevant building regulations, or any particular regulation or practice specified by the local electricity supply company.
3. The plumbing installation must comply with all national or local water regulations and all relevant building regulations, or any particular regulation or practice specified by the local water company or water undertakers.
4. Switch off the appliance at the electrical isolating switch when not in use. This is for safety and is recommended with all electrical appliances.
5. This appliance is not suitable for use with any form of electronic timer. The shower must be shut down in accordance with the instructions contained in this installation guide, or the separate user guide.
6. Having completed the installation, make sure that the user is familiar with the operation of the appliance.
7. When this appliance has reached the end of its serviceable life, it should be disposed of in a safe manner, in accordance with current local authority recycling, or waste disposal policy.
8. Please pass this guide on in the event of a change of ownership of the installation site.

PACK CONTENTS

Tick the appropriate boxes to familiarise yourself with the part names and to confirm that the parts are included.

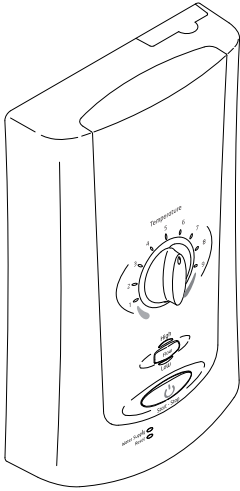

Or

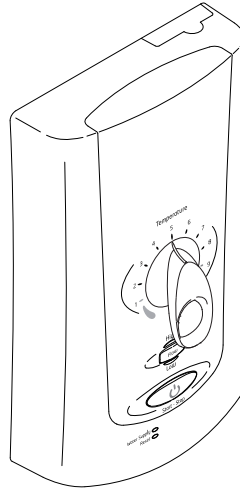

1 x Mira Advance Low Pressure Standard

1 x Mira Advance Low Pressure Flex



1 x Compression Nut



4 x Wall Screws

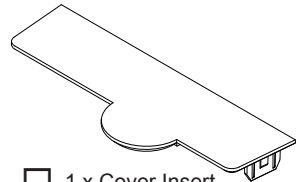

1 x Cover Insert (blank)



1 x Olive

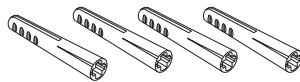

4 x Wall Plugs

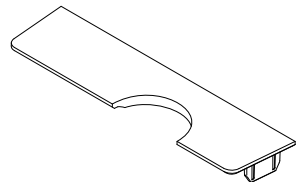

1 x Cover Insert (pipe)

Documentation

- 1 x User Guide
- 1 x Installation Template
- 1 x Guarantee Registration Document
- 1 x BEAB Care In-Service Test Record



4 x Rubber Feet

SPECIFICATIONS

Plumbing Supply	Supply Source	Gravity fed or pumped cold water only.
	Maximum Static Pressure	100 kPa (1 bar)
	Minimum Static Pressure	0.8 kPa (0.008 bar) (10 kPa BEAB Care)
	Maximum Inlet Temperature	30°C (20°C BEAB Care)
	Minimum Inlet Temperature	2°C (5°C BEAB Care)
	Inlet Connection	½" BSP male & 15 mm compression fitting.
	Outlet Connection	½" BSP male fitting
Electrical Supply	Nominal Rating at 230 V	8.3 kW
	Nominal Rating at 240 V	9.0 kW
	Supply Fuse/Circuit Breaker	40 Amps
	Residual Current Device RCD	30 mA
	Supply Cable	No larger than 16 mm ² Note: Refer to current IEE regulations and BS 7671 to determine minimum cable size.
	Isolation Switch	45 Amp Double pole, with 3 mm contact separation.
Maximum Ambient Temperature		30°C
Minimum Ambient Temperature		2°C
Duty Cycle		30 minutes on / 30 minutes off.

Standards and Approvals

The Mira Advance ATLP complies with the requirements of the BEAB Care Mark Standard and the relevant directives for CE marking.

The BEAB Care mark is invalid if the product is not installed and used in accordance with the manufacturer's specifications and instructions.

Dimensions

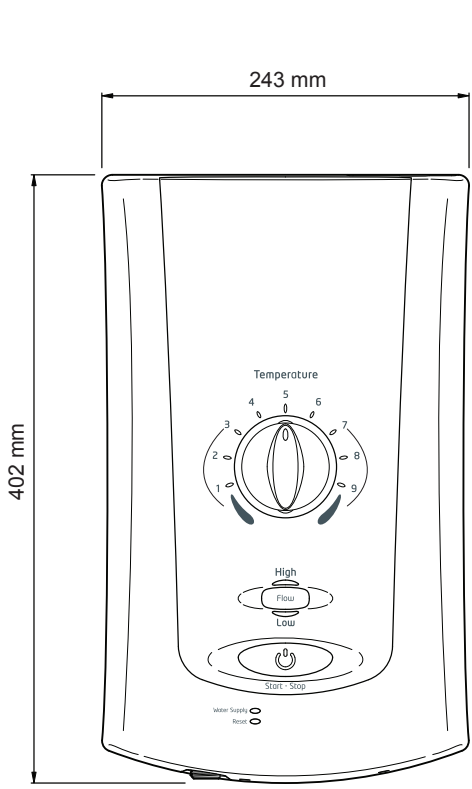

Advance Low Pressure
Standard

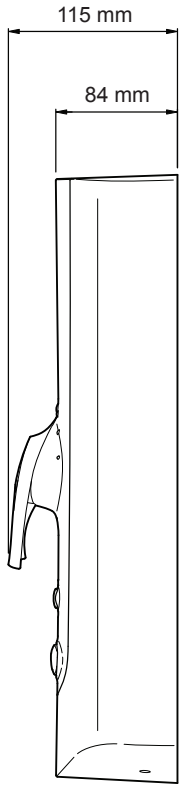
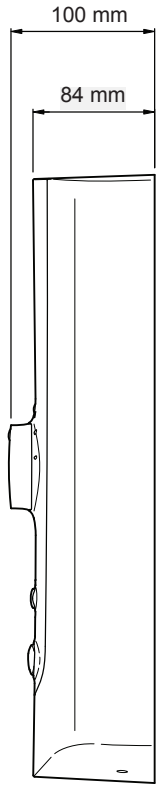

Advance
Low Pressure Flex

INSTALLATION REQUIREMENTS

General

We recommend that the product be brought into the room where it is to be installed and left to acclimatise to room temperature, this will reduce the possibility of condensation on electronic components. This product works best when supply temperatures and pressures remain stable and within the product specifications, refer to section '**Specifications**'. If the supply conditions fall outside the specifications, the shower may go into a safe shut down condition.

If pipework and/or electrical cables enter the shower from the rear through a hole in the wall, provision must be made to prevent water ingress back into the wall structure.

1. Plumbing

Refer to section: '**Important Safety Information**' first.

1.1 The shower is designed to operate with gravity fed water supplies providing pressures from 0.8 kPa * (0.008 bar / 80 millimetres head) to 100 kPa (1 bar / 10 metres head) (i.e. the vertical distance from the base of the cold cistern to the top of the main unit of the shower). The unit should be never be fitted to a mains supply or where the above maximum pressure may be exceeded. Failure to comply with this may result in product damage leading to significant uncontrolled leakage from the unit.

* Note: In practice the minimum head required will increase with pipe length and the guide given in the section '**Pipework**' should be used to make sure that adequate head is available for any given installation.

The shower **MUST** have its own separate supply from the cistern.

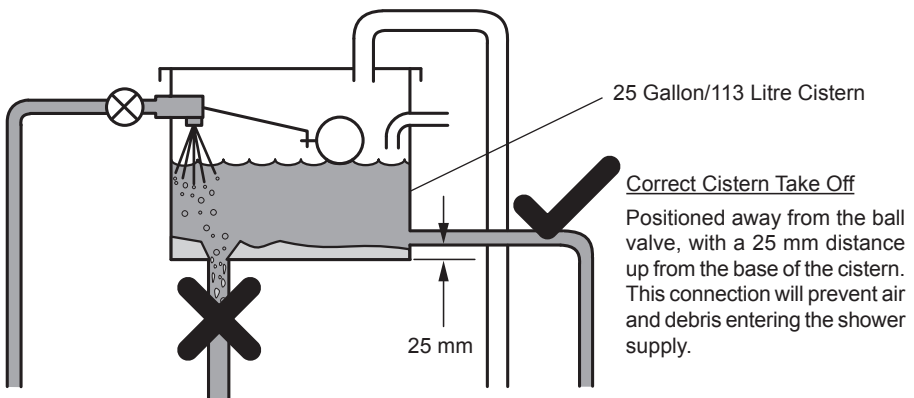

Incorrect Cistern Take Off

Debris from the bottom of the cistern and air generated when the cistern refills will enter the shower supply.

- 1.2 Do not use sealing compounds on any pipe fittings or joints.
- 1.3 To avoid damage to the case when soldered fittings are used, pre-solder the pipework and fittings before connecting them to the inlet connector assembly.
- 1.4 Avoid layouts where the shower hose will be sharply kinked. This may reduce the life of the hose.
- 1.5 Supply pipework **MUST** be flushed to clear debris **BEFORE** connecting the appliance. Debris will reduce the performance of the shower.
Avoid running the pipework through excessively hot or cold areas such as hot loft spaces, airing cupboards, or in close proximity to hot water pipes. If this cannot be avoided, we would recommend insulating the pipes.
- 1.6 The shower must be fitted onto a tiled or sealed finished surface, i.e. on top of the tiles. **DO NOT** tile up to the sides of the shower or use a sealant around the case. Failure to do this may cause appliance failure. To ensure the case and other components are not put under strain during installation always provide mechanical support when making plumbing connections. Upon completion of the installation ensure connections and back case are not under any stress due to misaligned pipework or electrical cables.
- 1.7 We recommend that a non-restrictive (free flowing) isolating valve is fitted in the cold water supply pipe from the cistern to the shower, to allow maintenance of the shower.
- 1.8 When installed in very hard water areas (above 200 ppm temporary hardness) your installer may advise the installation of a water treatment device, to reduce the effects of limescale formation. Any malfunction due to limescale is not covered by the manufacturer's guarantee. Your local water company will be able to advise the hardness of water in your area.
- 1.9 To prevent the possibility of backsiphonage, the handset must be prevented from reaching within 25 mm of the spillover level of any bath, shower tray or washbasin. The supplied hose retaining ring should enable this to be achieved for the majority of shower installations. However, there will be occasions when the hose retaining ring will not provide a suitable solution. In these instances, a double checkvalve must be fitted to the outlet. Double checkvalves fitted in the shower's inlet supply can cause a pressure build-up, which could exceed the maximum static inlet pressure for the appliance. The handset must be prevented from reaching within 30 mm of the spillover level of any WC, bidet or other basin that is classified higher than fluid category 3.
- 1.10 Rear entry plumbing is accommodated without the need to recess the 15 mm inlet compression connector. If pipework and/or electrical cables enter the shower from the rear through a hole in the wall provision must be made to prevent water ingress back into the wall structure.
- 1.11 The shower is fitted with a pump motor, and some mechanical noise can be expected in addition to the noise generated by the spray from the handset. The type of wall surface will affect the perceived sound levels. Stud partition and panel walls have a tendency to resonate, whilst solid walls provide the quietest

operation. The tone of the pump motor may change when the temperature control knob is adjusted. This is quite normal.

1.12 Use a minimum of 15 mm diameter supply pipework. It should be noted, however, that on long pipe runs this should be increased to 22 mm (refer to section **'Pipework'** for guidance). When using flexible plastic pipe it is essential that the pipe is kept flat and not looped up at any point as this may lead to air build up.

1.13 Long pipe runs and excessive use of 90° elbows will significantly reduce the available head to supply the shower. The pipework table should be completed to ensure that adequate head is available for any given application.

Pipework

The dimension (x) is calculated from the table below to give you a minimum effective head of 80 mm which is necessary to produce a satisfactory shower in all conditions.

Plumbing Schematic Diagram

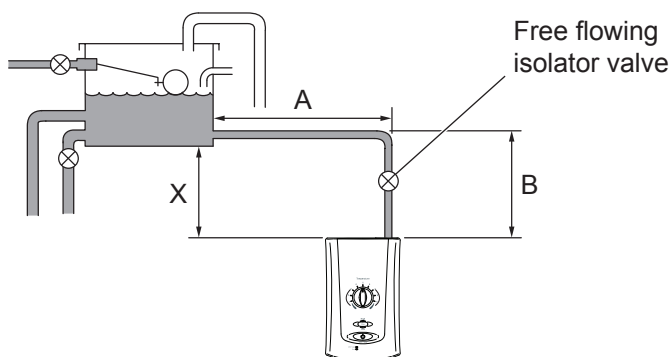

Example! The example below is based on the diagram above with 15 mm pipework, A = 1.5 m, B = 0.75 m.

Size	Quantity	Head Loss (mm)
15 mm Pipe	(A) <u>1.5</u> + (B) <u>0.75</u> = <u>2.25</u> x 120	270
22 mm Pipe	(A) <u> </u> + (B) <u> </u> = <u> </u> x 20	
15 mm Elbow	Number of Elbows <u> 1 </u> x 55	55
22 mm Elbow	Number of Elbows <u> </u> x 15	
	Minimum Effective Head	80
	(x) mm	405

2. Electrical

Refer to section: '**Important Safety Information**' first.

2.1 In a domestic installation, the rating of the electricity supplier's fuse and the consumer unit must be adequate for the additional demand. All Mira Advance ATLP pumped electric showers are high power appliances, so it is essential to contact the electrical supply company to make sure that the supply is adequate for the appliance. Voltage drop due to local heavy demand will reduce the shower's performance.

2.2 The appliance must be earthed by connecting the supply-cable earth conductor to the earth terminal.

Any supplementary bonding and supply cable size must conform to **BS 7671**.

2.3 As a guide only, and in accordance with **BS 7671** we recommend close circuit protection:

i.e. **9.0 kW = 40 Amp**

In accordance with **BS 7671**, a 30 mA Residual Current Device (RCD) **MUST** be included in the electrical circuit. This may be part of the consumer unit or a separate unit.

A separate, permanently connected supply must be taken from the consumer unit to the appliance through a double-pole switch, which has at least 3 mm contact separation. The switch can be a ceiling mounted pullcord type or a wall mounted switch in the applicable zone area.

2.4 DO NOT exert strain on the terminal block. Make sure that the electrical connections are tightly screwed down.

2.5 Unless otherwise stated, electrical equipment such as extractor fans, pumps must not be connected via this product.

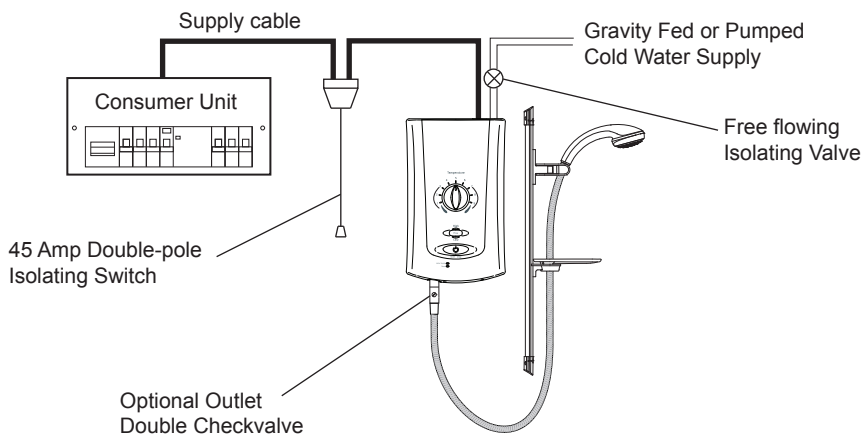

Electrical Schematic Diagram

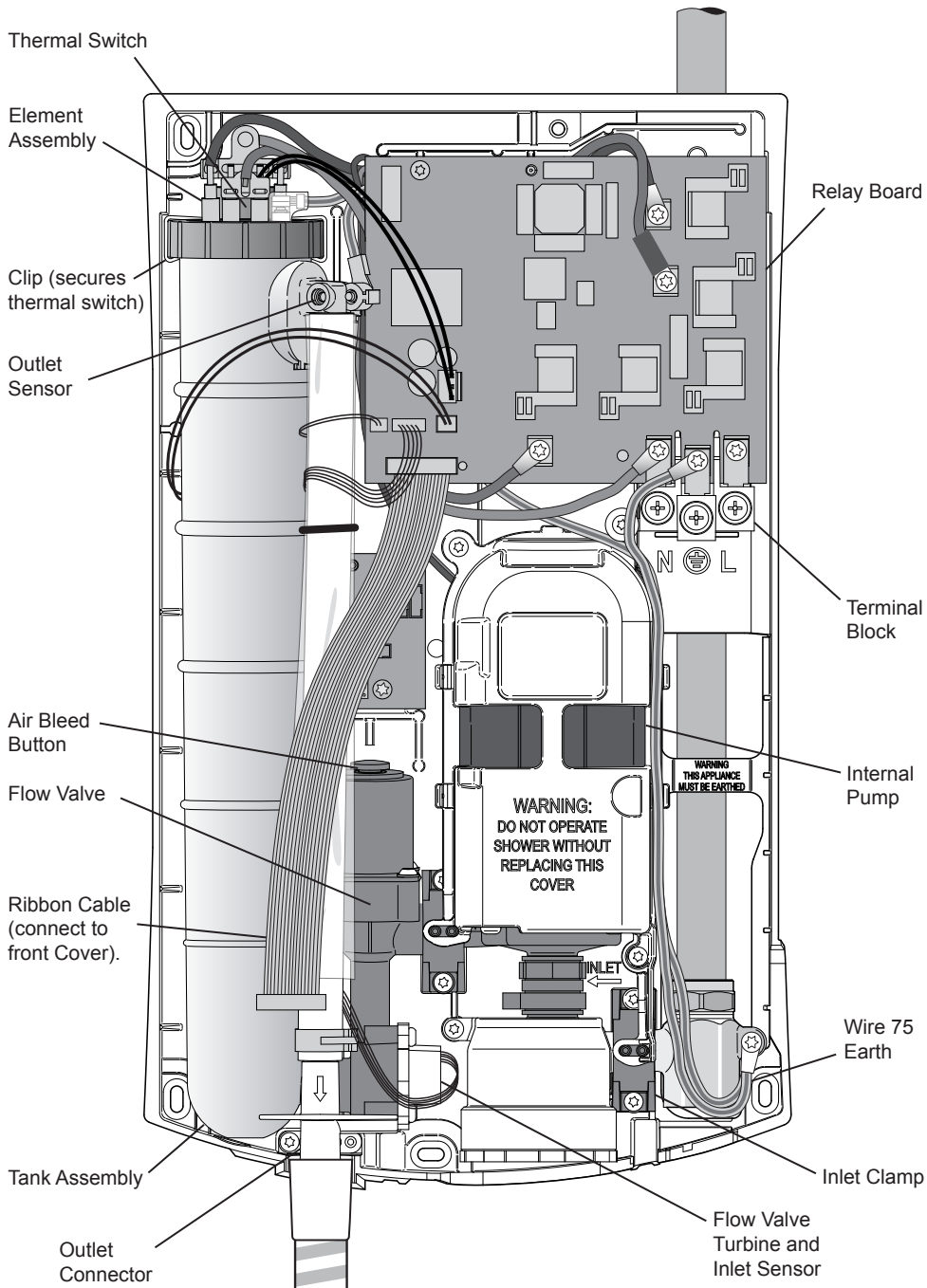

Mira Advance Low Pressure

INSTALLATION

Refer to section: 'Important Safety Information' first.

This installation covers all models of the Mira Advance ATLP Thermostatic shower.

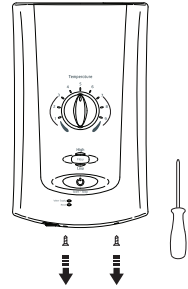
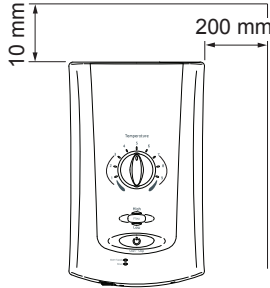

1. Electrical supply is turned off at the mains.
2. Determine the shower position, leaving adequate space for maintenance.
3. Remove cover screws.

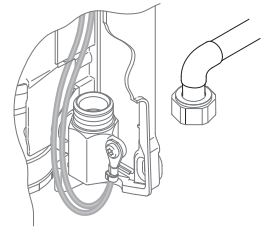
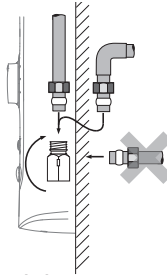
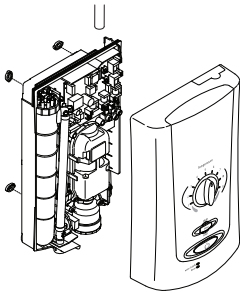

4. Remove front cover. Determine supply pipe position.
5. Turn inlet connector to suit supply pipe. **Do not trap green (earth) wires.**
6. Complete any soldering required away from appliance.

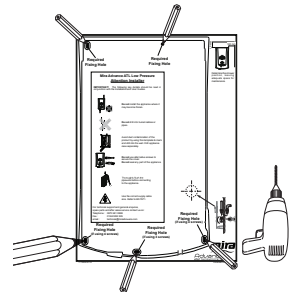
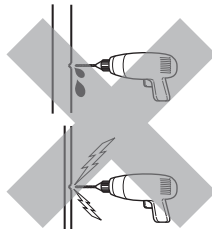
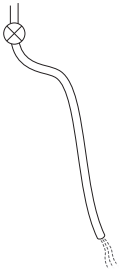

7. Flush a minimum of 10 litres (2 gallons) through pipework prior to connection.
8. **Caution!** Do not drill into buried cables or pipes.
9. Use template provided to mark and drill required fixing holes. Screws and plugs are supplied for 4 holes.

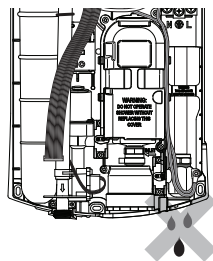
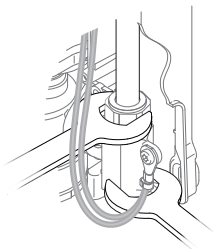
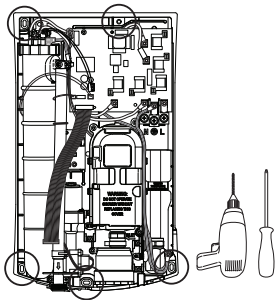

10. Drill holes through plastic case as required. Fix appliance to wall. (Make sure rubber feet are fitted with all holes used.)

11. Connect supply pipe. **Do not** overtighten.

12. Turn on water supply and check the pipe connections for leaks .

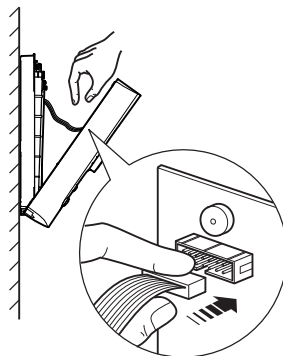
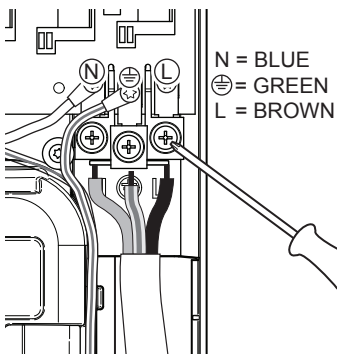
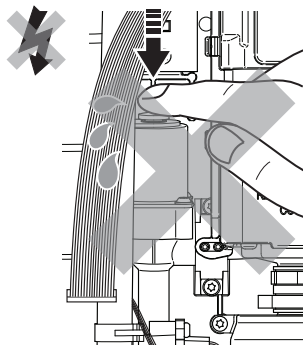

13. Important! This shower does not require bleeding.

14. Feed cable into case and strip insulation. Firmly connect the conductors. **DO NOT** exert strain on terminal block.

15. Connect ribbon cable to the inside of the cover.

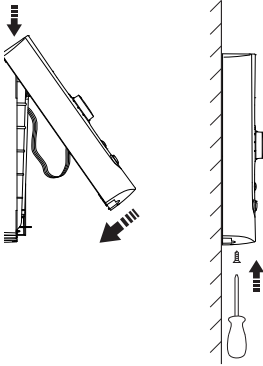

16. Refit cover using the 2 screws provided. **DO NOT** use alternative screws to secure the cover as this can cause damage to the appliance.

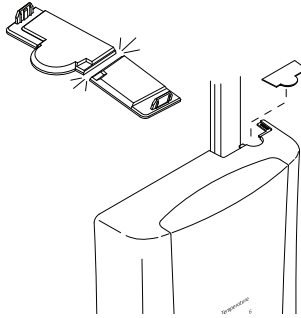

17. Plastic Inserts are provided to finish the top of the cover as required. Can accommodate sizes up to 25 mm Electrical Cable Trunking.

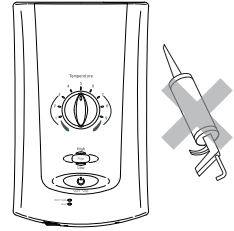

18. Do not seal around any part of the appliance.

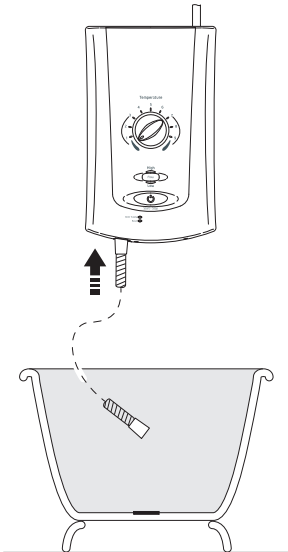

19. Connect hose and showerhead, pointing into bath or tray.

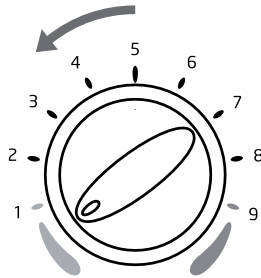

20. Temperature to full cold.



21. Turn on electrical supply.



22. Power to appliance, check **Start/Stop** for blue light.



23 Start shower to prime pump.

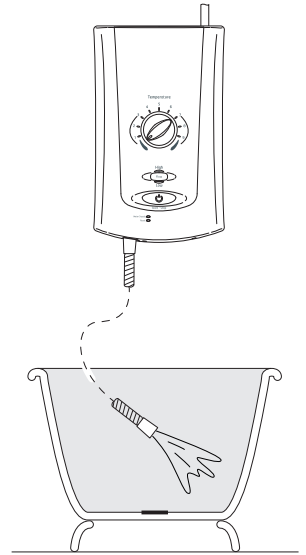

24. Allow water to flow until all air has been purged.

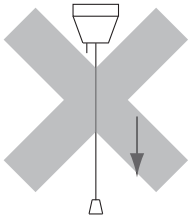

25. Push **Start/Stop** to turn off the appliance. The pulsing light and "beep" indicates that the appliance is shutting down. **Important! DO NOT** isolate the power until the water has stopped.

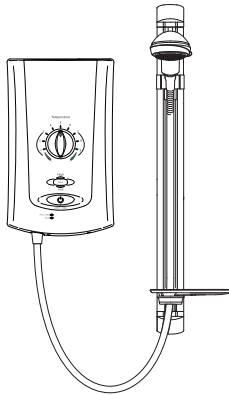

26. Install the shower fittings. Refer to separate Installation and User Guide.

COMMISSIONING

On initial installation, the appliance needs to 'learn' about the site conditions and does so during the commissioning cycle.

Once set, the shower constantly updates it's memory with information about the site conditions to deliver the best performance.

DO NOT commission the appliance if water leaks from the unit.

Set Maximum Temperature and Commissioning Cycle

1. Shower is **OFF**.
Water has **STOPPED** flowing.
Power/Electric is **OFF**.

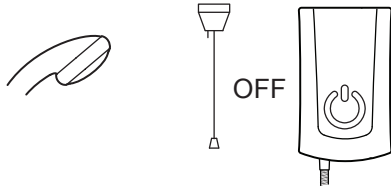

2. Set Maximum Temperature

Turn the dial to the desired position in the table. This will set the maximum temperature for showering.

When showering, the set maximum temperature is reached when the dial is turned to number '9'.

(See also section: "BEAB Care".)

Record the Maximum Temperature setting on the BEAB Care In-Service Test Record (separate form supplied) if applicable to the installation.

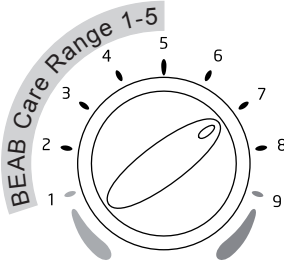



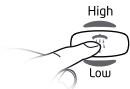
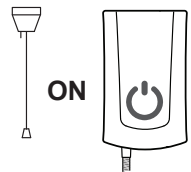

No.	Max. Temp °C
1	37
2	38
3	39
4	40
5	41
6	42
7	45
8	48

3. Turn Power/Electric **ON**.



Within 30 seconds push and hold **HIGH/LOW & START/STOP** buttons at the same time.



4.   1st Beep (LONG) - Release **START/STOP**. 
 2nd Beep (SHORT) - Release **FLOW**. 

5. HIGH FLOW LIGHT FLASHES

This indicates the shower is commissioning.
 Water flows for approximately 1 minute 20 seconds.
 In some cases the cycle can take up to 3 minutes.
 Allow the shower to stop automatically.



IMPORTANT! DO NOT INTERRUPT THE CYCLE!

FLOW LIGHT doesn't flash... solution ...Restart the commissioning cycle as step one.

6. Push **START/STOP** to turn the shower **ON**.
 Check that the maximum temperature is acceptable to the user.

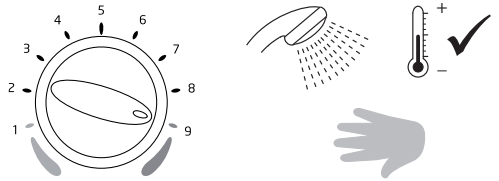

7. Push **START/STOP** to turn the shower **OFF**.
 Wait until the water has stopped flowing **BEFORE** turning the Power/Electric **OFF**.

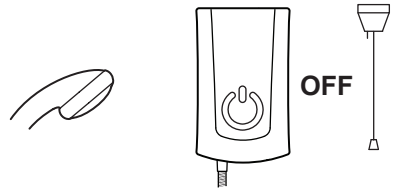

8. Residual water may drain over a few minutes.



BEAB Care

If the shower's maximum temperature is set to 41 °C or cooler, there is a clear triple beep tone and single pulse of the **Start/Stop** light every time the double pole switch is turned on. This is to indicate that the appliance is in a '**BEAB Care**' compliant mode. If recommissioning is required whilst in this mode, wait until beeps have passed before starting the commissioning cycle.

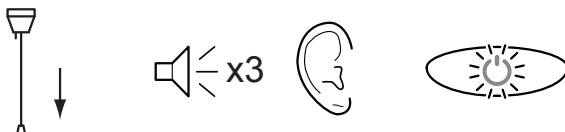

When set in 'BEAB' mode, the maximum set temperature is reached when the temperature control is turned to number '9'.

MAINTENANCE

Tradesperson Maintenance - Inlet Filter Cleaning/Replacing

Read the section 'Important Safety Information' first.

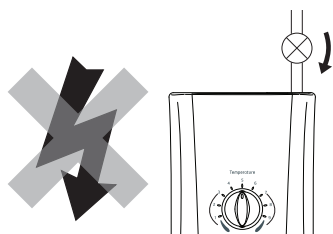

1. Electrical and water supplies to the appliance are turned off.

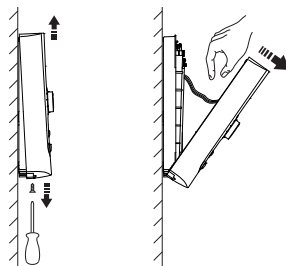

2. Remove the cover screw, cover and splash guard. Disconnect the ribbon cable from the cover

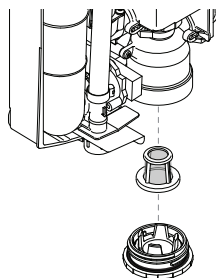

3. Unscrew the filter cap. Remove, clean and refit, or replace the filter as necessary. Refit the filter and the filter cap, making sure it is screwed fully home.

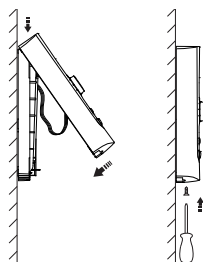

4. Restore the water supply and check for leaks. **Re-prime the appliance** (refer to 'Installation') before restoring the electricity supply. Refit ribbon cable and cover.

FAULT DIAGNOSIS

1. Installer Troubleshooting Guide

Refer to section: 'Important Safety Information' first and refer also to 'User Trouble Shooting Guide'.

The following troubleshooting solutions may require the removal of the cover of the shower. The cover should only be removed by a competent tradesperson and when doing so they should be aware of the following:

- Isolate the electrical and water supplies before initially removing the cover.
- Make sure Ribbon Cable is disconnected when removing the front cover and reconnect when maintenance is complete.

- Mains connections are exposed when the cover is removed.
- Refer to wiring diagram before making any electrical connections.
- Make sure all electrical connections are tight to prevent arcing/overheating.
- Make sure all plumbing connections are watertight.

When following these instructions, it is sometimes necessary to examine the appliance with the electrical and water supplies turned **on**. It is therefore essential that the appropriate safe working practices are followed in accordance with the current Health and Safety Legislation.

If conducting a continuity check using a multimeter, make sure the electrical supply is **ISOLATED**.

2. DIAGNOSTIC PROCEDURE

1. Ensure the shower pullcord / isolator switch is in the **OFF** position, then turn **ON** the pullcord / isolator switch.
2. If the unit 'Beeps' & the Start / Stop button is flashing **WAIT for 20 SECONDS** until the button stops flashing.

NOTE! If the Start / Stop button continues to flash & no beep was heard upon start up, then the failure is due to a sticking switch on the Control PCB - Refer to **ERROR CODE 16** on the fault code sheet.

3. Start the shower & observe light fault indication (if any) & refer to Error Code Sheet to determine failure and rectify.

NOTE! If the shower operates normally run the unit for at least 5 minutes at showering temperature & ensure the temperature remains stable.























4. Turn the shower off at the Start / Stop Button & observe 'phased shutdown'. **DO NOT** isolate the power at the pullcord / isolator switch until the water flow stops.
5. Turn off the power at the pullcord / isolator switch, then turn the power back on and commission the shower.
6. Run the shower for at least 5 minutes.
7. Show the user the correct start / stop procedure and general operation of the shower. Advise user that isolating the shower before the flow has stopped may damage the shower.

For all fault codes 0 to 14 the reset light will be on or flashing. This will require the shower to be turned off at the pullcord / isolator switch to reset the unit. When the pullcord / isolation switch is turned back on the shower may beep and the Start / Stop button may flash. If this occurs go back to action number 2 and re-follow the Diagnostic Procedure.





Advance² Error Codes X - 7 / Display, Causes and Rectification

No light  Flashing light  Solid light 

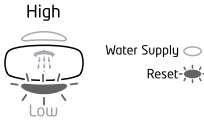
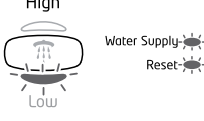
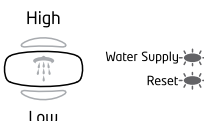
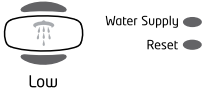
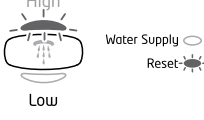
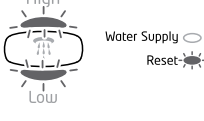
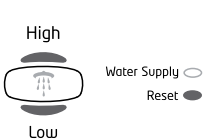
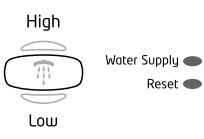
For all fault codes 0 to 14 the Reset light will be on or flashing. This will require the shower to be turned off at the pullcord / isolator switch to reset the unit. When the pullcord / isolation switch is turned back on the shower may beep and the Start / Stop button may flash. If this occurs go back to action number 2 and re-follow the Diagnostic Procedure

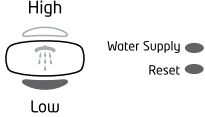
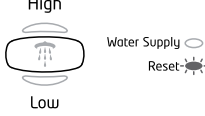
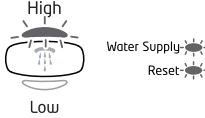
Error Code	Indicator Display	Possible Cause/Rectification
X	All lights in a normal state	No fault found
A	Water Supply  OR  Reset 	Problem with water supply, unit still operates. 1. Check all isolator valves are fully open. 2. Clean / replace filter, refer to section: 'Maintenance' . 3. Check Inlet Temperature not too high. 4. Blocked Hose / Handset.
0	High   Water Supply  Low  Reset 	An unidentified error has occurred. 1. Replace Control PCB / Cover.
1	High   Water Supply  Low  Reset 	Incoming flow too low for appliance to operate safely. 1. Check all plumbing isolator valves to the shower are turned fully on 2. Reset - Commission the shower. 3. Blocked or partially blocked filter. 4. A section of the supply pipe may be frozen (thaw). (Advise customer of incorrect installation) 5. Replace Flow Valve. 6. Replace Thermal Switch. 7. Replace Heater Tank. 8. Check header tank installation height. 9. Ensure Pump is running.
2	High   Water Supply  Low  Reset 	Internal electrical supply problem. 1. Replace Relay Board. 2. Replace Control PCB / Cover. 3. Replace Thermal Switch.
3	High   Water Supply  Low  Reset 	

4		<p>Appliance has been incorrectly shut down.</p> <ol style="list-style-type: none"> 1. Replace Relay Board & Control PCB / Cover TOGETHER. <p>Advise the user on correct start/stop procedure and general operation of the shower, refer to User Guide.</p>
5		<p>Incoming water temperature too high.</p> <ol style="list-style-type: none"> 1. Check inlet water temperature is not too high. 2. Replace Flow Valve. 3. Replace Control PCB / Cover.
6		<p>Flow Valve Assembly is disconnected or faulty.</p> <ol style="list-style-type: none"> 1. Check Multiway Cable Connection. 2. Check Flow Valve connection. 3. The shower or a section of the supply pipe may be frozen. 4. Replace Flow Valve. 5. Replace Control PCB / Cover.
7		<p>False flow reading/No shut off failure.</p> <ol style="list-style-type: none"> 1. Isolate power to the unit. Does the flow stop? No - Replace Flow Valve. Yes - Replace Relay Board.
8		<p>Safety relay failure.</p> <ol style="list-style-type: none"> 1. Check relay contacts. (debris on contacts or welded closed) 2. Check Multiway Cable Connection. 3. Replace Relay Board.
9		<ol style="list-style-type: none"> 4. Replace Control PCB / Cover. 5. Replace Thermal Switch.
10		<p>Internal Electrical Supply problem / Faulty Control PCB or Relay Board. Appliance has been incorrectly shut down.</p> <ol style="list-style-type: none"> 1. Push bleed button to flush the heater tank. 2. Replace Relay Board 3. Replace Control PCB / Cover. <p>Advise the user on correct start/stop procedure and general operation of the shower, refer to User Guide.</p>
11		<p>Outlet Sensor faulty or disconnected from Relay Board or faulty Control PCB.</p> <ol style="list-style-type: none"> 1. Check Outlet Sensor connection to the Relay Board. 2. Check Multiway Cable Connection. 3. Replace Control PCB / Cover. 4. Replace Relay Board. 5. Replace Heater Tank.

12		<p>Unsafe hot water detected.</p> <ol style="list-style-type: none"> Unit incorrectly shut down causing hot water to trip the max temp limit, this would be following ERROR 17. Hot water in the heater tank, bleed via the blue button. Check Outlet Sensor connection to the Relay Board. Check Multiway Cable Connection. Replace Control PCB / Cover. Replace Relay Board. Replace Heater Tank. <p>Advise the user on correct start/stop procedure and general operation of the shower, refer to User Guide.</p>
13		<p>This failure only occurs during commissioning.</p> <ol style="list-style-type: none"> Check operation of relays / replace Relay Board Replace Flow valve. Replace Control PCB / Cover. Check resistance of Heater Tank elements./ replace Heater Tank.
14		<p>Error lights when unit is re-started.</p> <p>This error occurs when the shower has been incorrectly shutdown and the unit senses over temperature (refer to ERROR 17).</p> <p>Advise the user on correct start/stop procedure and general operation of the shower, refer to User Guide.</p>
15	 <p>Lights flashing in peculiar ways.</p>	<p>Unit fails to start.</p> <ol style="list-style-type: none"> Replace Relay Board and Control PCB / Cover TOGETHER.
16		<p>High & Low or Start / Stop lights pulsing rapidly.</p> <ol style="list-style-type: none"> Associated Button stuck / Replace Control PCB / Cover.
17		<p>Start / Stop Lights Pulsing Slowly</p> <ol style="list-style-type: none"> If a 2 second beep and the Start / Stop button is pulsing SLOWLY = Appliance has been incorrectly shut down. Refer to Diagnostic Procedure action number 2. <p>Advise the user on correct start/stop procedure and general operation of the shower, refer to User Guide.</p>

Unattended Operation

The appliance has a built in 'Shower Stop' timer to protect from accidental unattended operation. This feature automatically switches the shower off after 30 minutes of continuous use. Normal operation is restored by re-selecting the **Start/Stop** button, but should be allowed to cool for 30 minutes first.

1. Run the shower with the temperature control set to full cold and the flow set to high for 2 - 3 minutes and then stop the shower. Clean and if necessary renew the inlet filter (see Maintenance) but do not refit either the filter, the filter cap or the shower front cover.
2. Gradually turn on the water supply at the isolator valve enough to catch a small quantity of water in the cup or container and measure the temperature. Isolate the water supply again and record the temperature on the test record.
3. Switch on the electrical supply to the shower and measure the voltage at the terminal block. Isolate electrical supply again and record the voltage on the test record.
4. Refit the inlet filter and filter cap. Turn on the water supply and check for leaks. Reprime the shower (see Installation - Priming the Shower).
5. Remove the handset from the hose. Position the end of the hose to allow water to drain safely when the shower is running, if necessary secure the hose in this position.
6. **WARNING, LIVE ELECTRICAL WIRES ARE EXPOSED WHILE SHOWER IS RUNNING!**
Connect the ribbon cable to the cover. Switch on the electrical supply to the shower and run the shower with the temperature control turned to full hot and the flow set to high. Measure the supply voltage at the terminal block (this may require a second person to assist). Stop the shower, isolate the electrical supply and record the voltage on the test record.
(If the ribbon cable becomes disconnected the shower will assume a failure has occurred and stop automatically. Isolate the electrical supply, reconnect the ribbon cable and restart this section of the test.)
7. Refit the cover and screws. Refit the handset to the hose and reattach to the sidebar or handset holder.
8. Switch on the electrical supply to the shower and run the shower with the temperature set to full hot and the flow set to high. Using the plastic funnel, catch all the water flowing from the handset and measure the temperature of the water flowing from the funnel. Record the temperature on the test record. Using the flow measure cup, measure the rate of water flow from the funnel and record the result on the test record.
9. Run the shower set to full hot and the flow set to high. Slowly restrict the water supply to the shower by closing the isolating valve gradually until the water starts to cavitate. This is indicated by a change in the tone of the internal pump and a '*whooshing*' sound (typically this is achieved when the isolating valve is closed by at least half). Allow the shower to run for 2 - 3 minutes to make sure that it will operate continuously, then measure the water temperature and rate of flow as described in test 8 and record the results on the test record. If the shower will not run continuously for at least 2 minutes, then the isolating valve should be reopened fully and the shower reset and reprimed. Attempt a retest without closing the isolating valve as much as previously. When a successful test has been performed and recorded, reopen the isolating valve fully and set the temperature to mid blend. Stop the shower and isolate the electrical supply.

If the normal operation outlet water temperature has changed by more than 1 °C since the previous inspection, or if either of the outlet water temperature measurements are more than 2 °C above the maximum temperature setting, the shower handset, hose and inlet filter should be checked for blockages and cleaned and descaled or if required renewed. Checks should be performed to confirm that any check valves or other backflow prevention devices are working correctly and that any isolating valves in the supply pipework are fully open. The shower should be recommissioned at the relevant maximum temperature setting and retested. If the temperatures are not able to be brought in line with these requirements, **the shower must not be used.**

SPARE PARTS

416.38	Universal Inlet Clamp Bracket.
1643.100	Thermal Switch.
1643.103	Terminal Block/Earth Wire/Neutral Wire.
1643.149	Flow Valve Assembly.
1759.106	Cover and PCB Assembly (Standard).
1759.107	Cover and PCB Assembly (Flex).
1759.109	Cover Inserts (white) includes rubber case feet.
1759.110	Cover Inserts (grey) includes rubber case feet.
1759.111	Filter Assembly.
1759.112	Filter.
1759.113	Pump Motor Assembly.
1759.114	Pump Motor Cover.
1759.115	Relay Board (including screws).
1759.116	Screw Pack.
1759.117	Component Pack (components identified 'A').
1759.118	Seal Pack.
1759.119	Inlet Connector.
1759.147	Tank Assembly 9.0 kW/230 V (earth wire not included).

Warning! If the wiring layout is changed or amended, the product functionality and safety may be affected.

Warning! In the interests of safety, spares requiring exposure to mains voltage should only be fitted by competent persons.

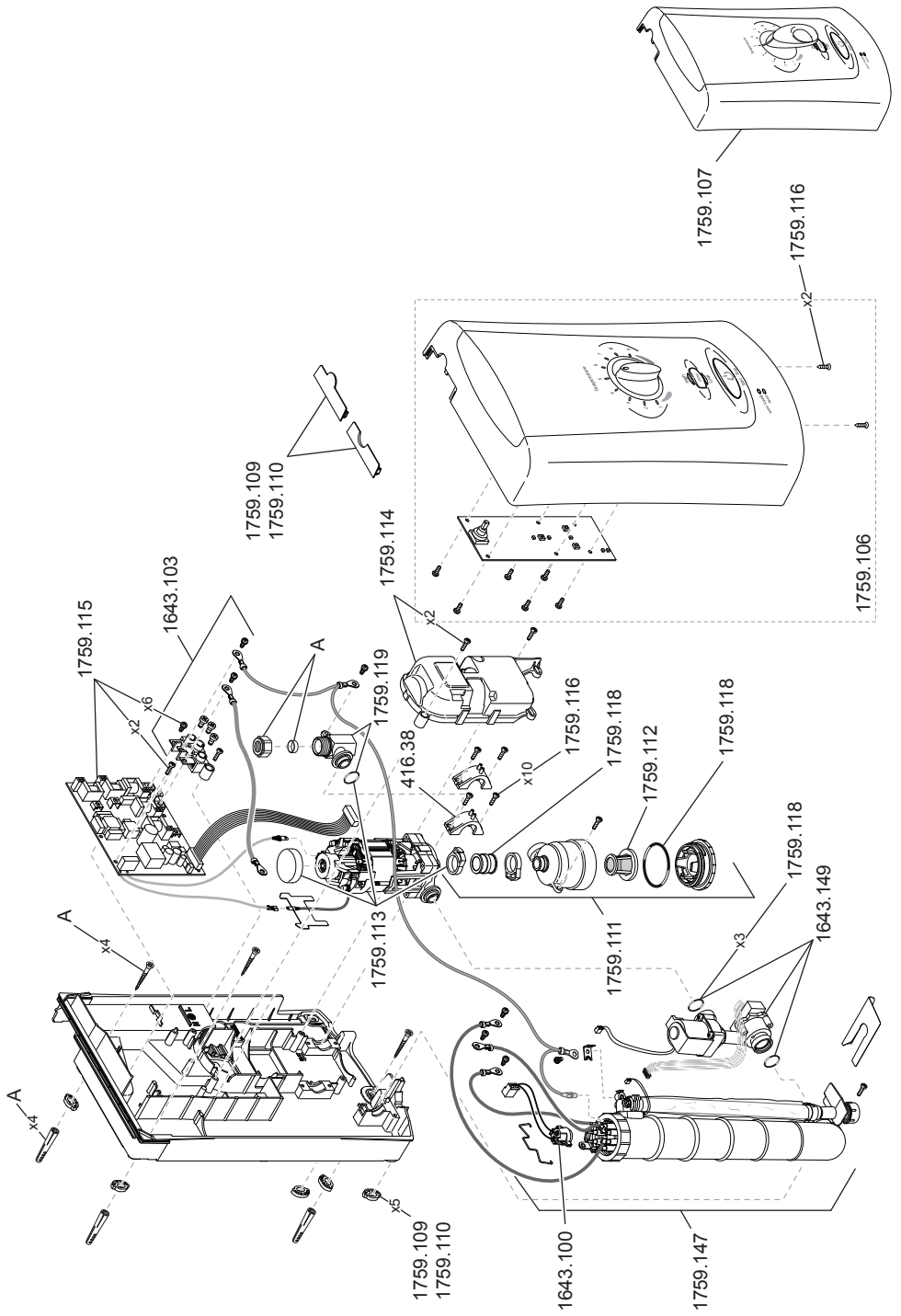

WIRING DIAGRAM

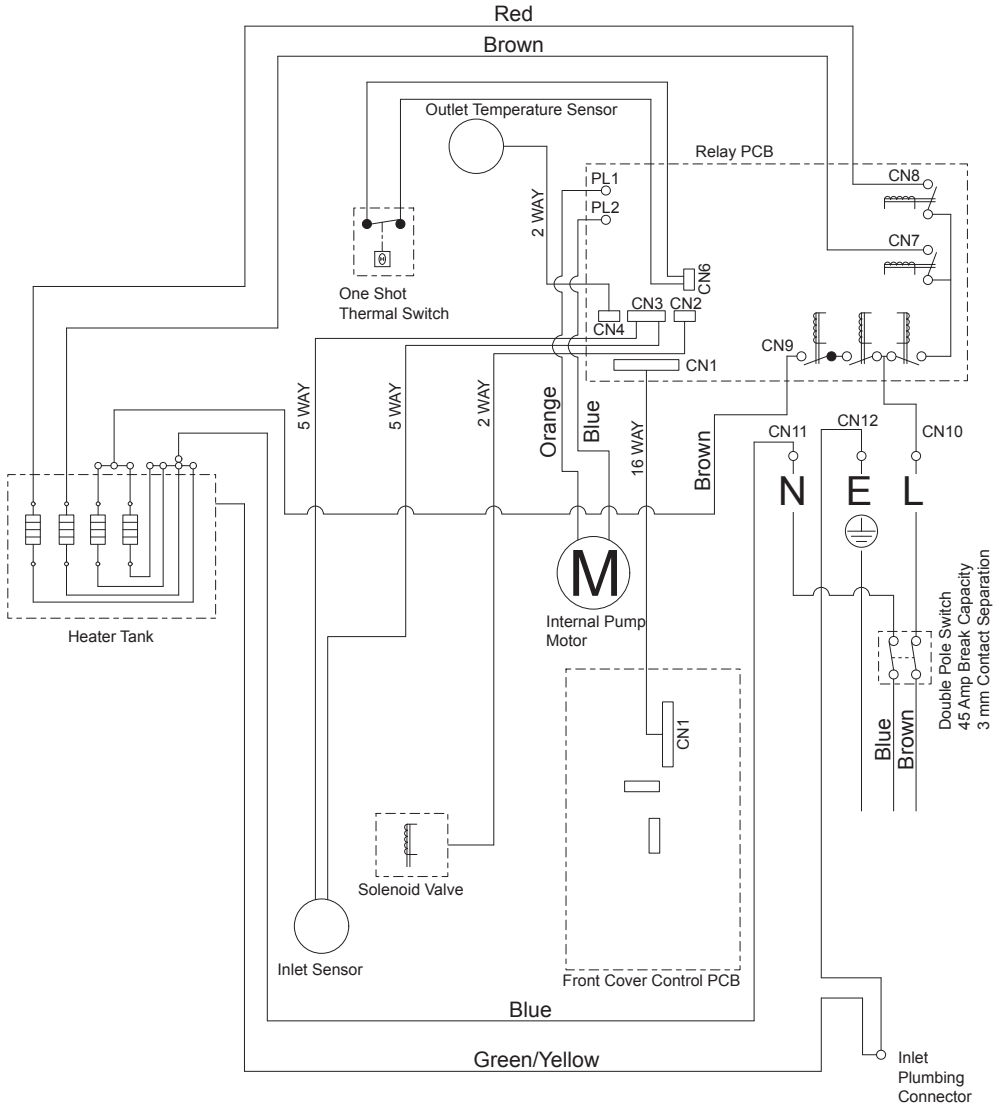

ACCESSORIES

Genuine Mira accessories can be purchased direct from Customers Services (our contact details can be found on the back cover of this guide) or from approved stockists or merchants.



Everclear Showerhead
White - 2.1616.030
Chrome - 2.1616.031

Mira's new Everclear range has been specially designed for hard water areas and reduces the risk of lime scale build up.

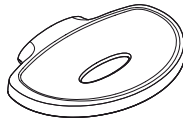

Wall Mounted Soap Dish
White - 1.1540.278
Chrome - 1.1540.279

Wall mounted for use anywhere in, or outside the showering area.

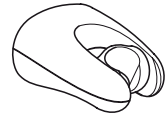

Logic Showerhead Holder
White - 2.1605.149
White/Chrome - 2.1605.150

An alternative to the traditional slide bar. Often a useful addition when positioned for the smaller members of the family.



Mira Standard Grab Bars
300 mm - 2.1605.070
450 mm - 2.1605.071
600 mm - 2.1605.072

Premium grade, highly polished, stainless steel grab bars.

Note! Must be installed onto a solid wall.

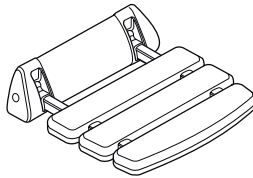

Shower Seat
White - 2.1536.128
White/Chrome - 2.1536.129

For use in or out of the showering area. Folds up when not in use. Maximum User Weight - 127 kg (20 stone) **Note!** Must be installed onto a solid wall.

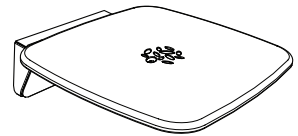

Premium Shower Seat
White/Chrome - 2.1731.001
Grey/Chrome - 2.1731.002

Stylish, slim-line and robust shower seat for use in or outside of the shower area. Folds up when not in use. Maximum User Weight - 150 kg (23.5 stone) **Note!** Must be installed onto a solid wall.

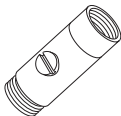

Outlet Double Check Valve (DCV-H)
Chrome - 1.0.110.55.1

An outlet double check valve, designed to prevent the back flow or back-siphonage of potentially contaminated water, through shower controls which are fitted with a flexible shower hose as part of the outlet shower fitting.

CUSTOMER SERVICE

Guarantee

Your product has the benefit of our manufacturer's guarantee which starts from the date of purchase.

To activate this guarantee, please return your completed registration card, visit our website or free phone 0800 0731248 within 30 days of purchase (UK only).

Within the guarantee period we will resolve defects in materials or workmanship, free of charge, by repairing or replacing parts or product as we may choose.

This guarantee is in addition to your statutory rights and is subject to the following conditions:

- The guarantee applies solely to the original installation under normal use and to the original purchaser only. The product must be installed and maintained in accordance with the instructions given in this user guide.
- Servicing must only be undertaken by us or our appointed representative. **Note!** if a service visit is required the product must be fully installed and connected to services.
- Repair under this guarantee does not extend the original expiry date. The guarantee on any replacement parts or product ends at the original expiry date.
- For shower fittings or consumable items we reserve the right to supply replacement parts only.

The guarantee does not cover:

- Call out charges for non product faults (such as damage or performance issues arising from incorrect installation, improper use, inappropriate cleaning, lack of maintenance, build up of limescale, frost damage, corrosion, system debris or blocked filters) or where no fault has been found with the product.
- Water or electrical supply, waste and isolation issues.
- Compensation for loss of use of the product or consequential loss of any kind.
- Damage or defects caused if the product is repaired or modified by persons not authorised by us or our appointed representative.
- Routine maintenance or replacement parts to comply with the requirements of the TMV 2 or TMV 3 healthcare schemes.
- Accidental or wilful damage.
- Products purchased ex-showroom display.

What to do if something goes wrong

If your product does not work correctly refer to this manual for fault diagnosis and check that it is installed and commissioned in accordance with our instructions.

If this does not resolve the issue, contact us for help and advice.

Extended Guarantees

A selection of protection plans are available that enable you to cover repair bills (excludes Eire). Ring 01922 471763 for more details.



Helpdesk Service - Ring our Customer Services Team for product advice, to purchase spare parts or accessories or to set up service visit. You can contact us via phone or e-mail, details below. Please provide your model name, power rating (if applicable) and date of purchase.



Mira Showers Website (www.mirashowers.co.uk)

Visit our website to register your guarantee, download user guides, diagnose faults, purchase our full range of accessories and popular spares, or request a service visit.



Spares and Accessories - We hold the largest stocks of genuine Mira spares and accessories. Contact us for a price or visit our website to purchase items from our accessory range and popular spares.



Service/Repairs - No one knows our products better than our nationwide team of Service Technicians. We can carry out service or repair work to your product both during and after the guarantee period. Ask about our fixed price service repairs.

To Contact Us: UK



0844 571 5000



Fax: 01242 282595



E-mail: Visit www.mirashowers.co.uk/contactus



Mira Customer Services Dept, Cromwell Road, Cheltenham, Gloucestershire, GL52 5EP

To Contact Us: Eire Only



01 531 9337



E-mail: CustomerServiceEire@mirashowers.com

Mira is a registered trade mark of Kohler Mira Limited.

The company reserves the right to alter product specifications without notice.



mira
SHOWERS