

Installation Guide

4 Fold Bath Screen

Important

Please familiarise yourself with the fitting instructions before commencing fitting.

1. Check that you have the tools required.
2. Check that the installation site is compatible with size of screen supplied
3. Check all the screen components.
4. Check that the installation kit is complete

DO NOT attempt to install the product unless you can tick ALL 4 boxes as satisfactory.

The wall plugs supplied with the installation kit are for use in solid walls. Hollow or 'stud-partition' walls will require alternative fixings. Please consult a hardware supplier for the correct type.

It may also be necessary to consult your tiling supplier about the correct method for drilling your tiles.

USE SAFETY EYEWEAR WHEN DRILLING

Any parts missing or damaged must be reported to your supplier within 5 days of purchase. Inspect shower enclosure before fitting . No claims will be acceptable after product has been installed.

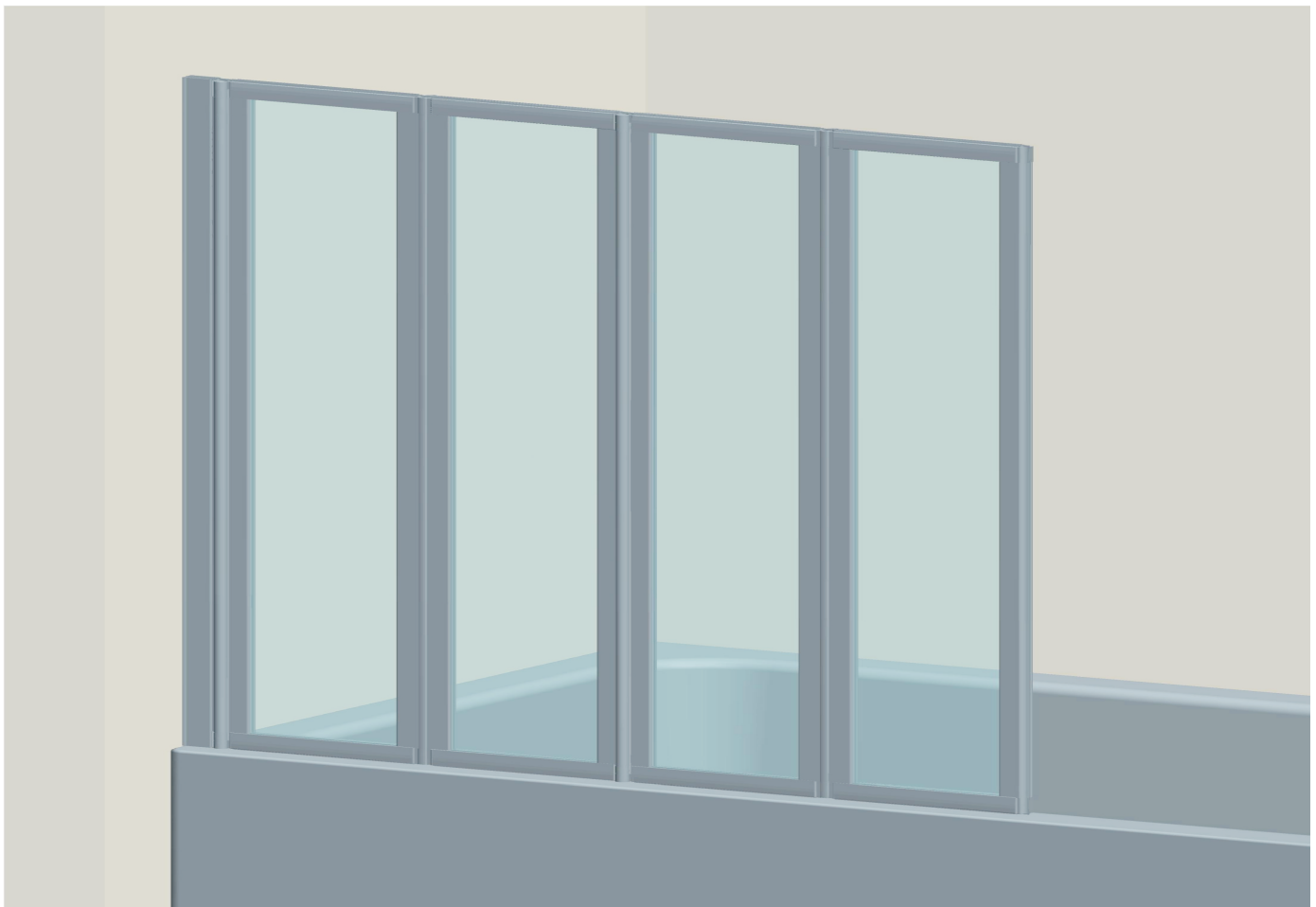

Tools Required

Power Drill 

Pencil 

Steel Drill bit, 3.0mm 

Spirit Level 

Masonry Drill Bit 6mm 

#2 Philips Screwdriver 

Tape measure 

Please read these installation instructions carefully before attempting to install the product.

Inspect Contents

Check that none of the parts or fittings are missing and that nothing is damaged. If anything is missing or damaged, contact your place of purchase/retailer within 5 working days.

Ensure your bath is level before fitting. This screen is not designed to fit on baths with stepped fronts, roll top rims or integral soap dishes.

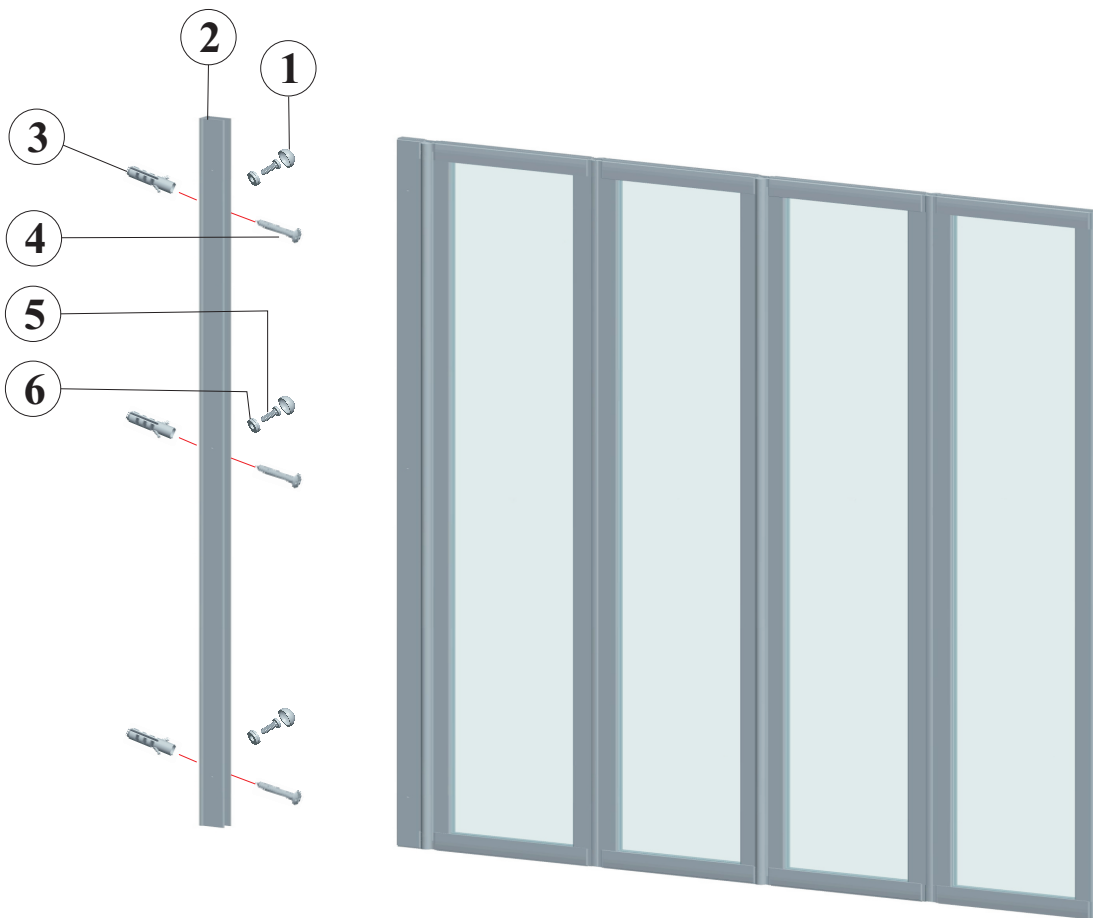

No.	Description	QTY	Part No.
1	Screw Cover Cap	3	A308
2	Wall Profile	1	P2D09101
3	Wall Plug	3	BB6304
4	Screw (4x30mm)	3	A2403001
5	Screw (4x12mm)	3	A2401201
6	Screw cover cap clip	3	A309

Installation

1. This bathscreen is reversible and can be used on the left or the right hand side of the bath.

IMPORTANT: Panel close to wall must fold to inside of bath.

2. Position the wall profile **P2D09101** so the seal on the moving panel sits on the inside edge of the bath. **Fig 2.**

FIG 2

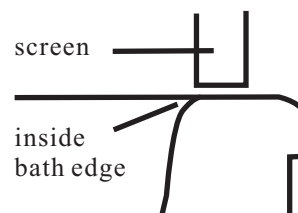

3. Plumb the wall profiles **P2D09101** using the vertical element of the spirit level. Mark 3 holes, drill with 6mm masonry bit and fit wall plugs **BB6304**. Using the 3 screw **A2403001** fix wall profiles to wall. **Fig 3.**

FIG 3

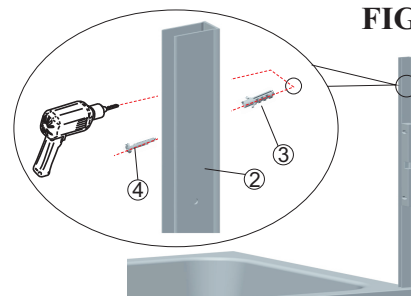

4. Insert the screen into the wall profile. Ensure the bottom seal on the moving panels are parallel to the top surface of the bath. **Fig 4.**

FIG 4

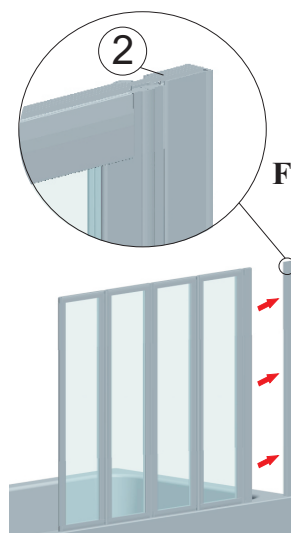

IMPORTANT: Ensure bottom seal is tight to bath top surface along the screen.

5. Drill 3 holes through the wall profile and fixed panel using a 3.0mm steel drill bit. Using the screws **A2401201**, and screw clips **A309**, fix the screen upright to the wall profile in 3 places. **Fig 5**

FIG 5

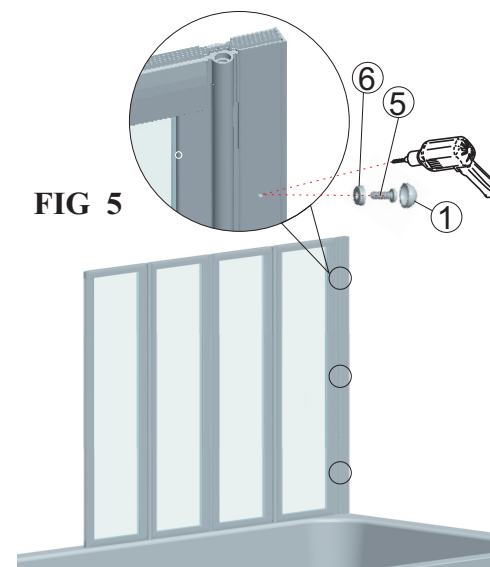

Sealing. Fig 6

Inside (dashed line)

When installation is complete seal the joint between the wall profile and the wall, top to bottom on the inside only. DO NOT SEAL where the wall profile sits on the Bath.

Outside (full line)

From outside the screen, SEAL where the wall profile sits on the bath. Seal 50mm up where the wall profile meets the wall and where the frame upright and the wall profile over lap.

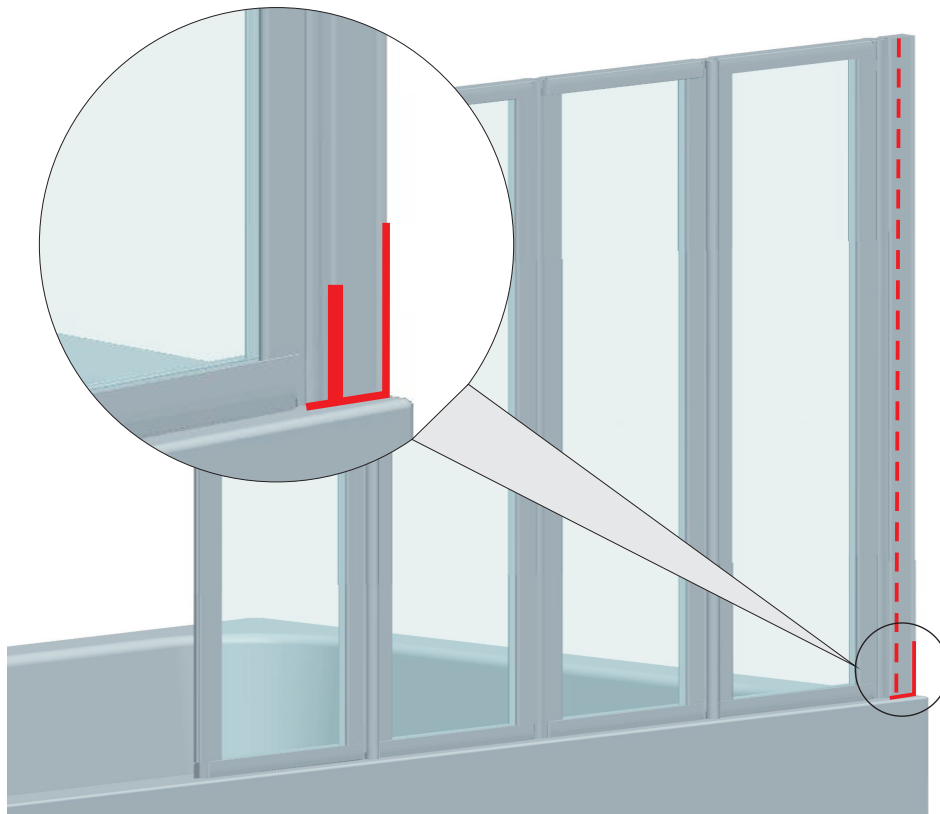

FIG 6



24 HRS

DO NOT USE THE
ENCLOSURE FOR
24 HOURS AFTER
SEALING

Visit our website, www.merlynshowering.com