

Insignia

INSTALLATION MANUAL

1100L | 1200L

Platinum Series



30 Day Technical Support: 01908 226545

This service is only available to customers from the day of delivery, please have your supplier's details and your postcode to hand before calling.

Replacements Parts: Inside of your warranty period contact: www.insigniarange.co.uk/support

Spares/Replacements Parts: Outside of your warranty period contact **0844 800 3069**

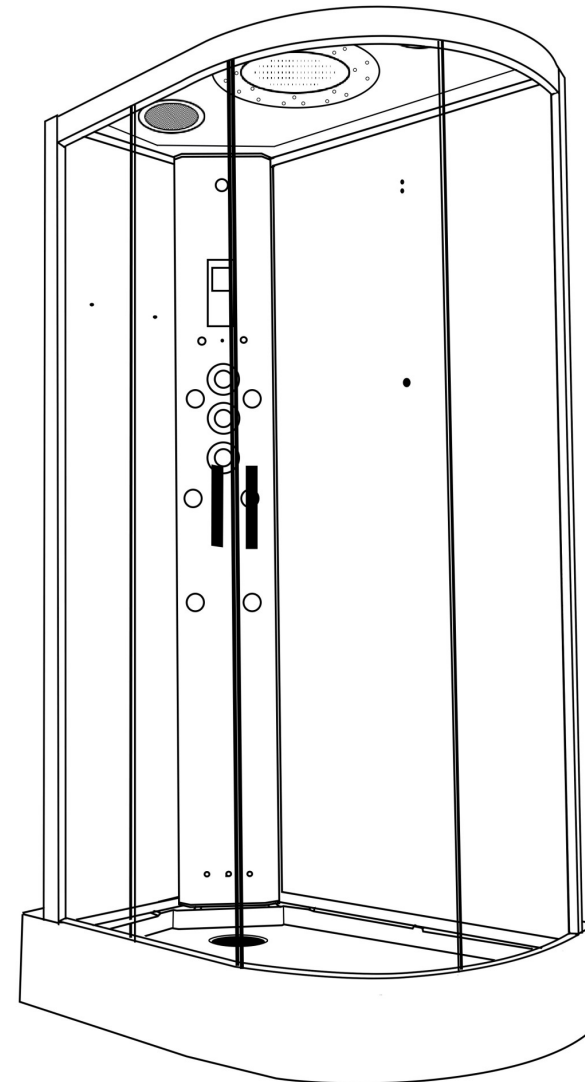

ATTENTION INSTALLERS:

These instructions must be left with the customer

CHECK ALL CONTENTS BEFORE BUILD COMMENCES. NO RETURNS CAN BE MADE ONCE THE BUILD HAS STARTED AS IT IS DEEMED ACCEPTANCE OF PRODUCT!

WARRANTY REG NO: _____

To claim your full 5 year warranty, register your shower within 90 days at: www.insigniarange.co.uk/warranty

Contents

Thank you for your purchase	3
Tips for assembly	4
Electrical/Pressure/Tool requirements	5
Box contents	6
Starting the installation	7
Accessory installation	16
Water valve connections	17
Control panel connections	18
Steam generator connections	19
Signing off your shower	20
Control panel instructions	21
Parts list	23

*Thank
You*

Thank you for your recent purchase of an Insignia shower. Please read this booklet with great care to ensure you get the best out of your build and have a shower that will last for many years to come! Like everything, in order to obtain a first class product that will serve you well for many years, the effort and correctness put into the assembly will reflect in the quality of your finish.

Before we start, here's our 4 top tips which may assist you...

TIP 1—Building Your Shower

This product is suitable for a DIY build, providing you are confident in your DIY abilities. Please look through this build guide and decide on whether you feel confident in undertaking this task. If you are not, seek the services of a professional and show them these instructions before hiring.

TIP 2—Hard Water

Due to the nature of this product we highly advise the purchase and fitting of a water softener.

(Please note: limescale build up may cause damage to your shower and will not be covered under warranty)

TIP 3—Installation

These showers are designed to be free standing and movable from their location should you have the need to replace anything.

ALWAYS USE Flexible braided water inlet pipes (not supplied) at least a metre long (not central heating plastic type!)

NEVER FIX with rigid pipes, **NEVER FIX** the unit to the wall or floor.

TIP 4—Sealing

When using Insignia's RubberGum, please ensure the product does not come in contact with your silicone as this will cause the RubberGum to fail and will not adhere as intended. RubberGum is immediately waterproof and will gain additional strength over time.

Electrical Requirements

Voltage Rating 220 -240AC

Frequency Rating 50HZ

Power Rating 2.8KW (steam version only)

Your electrical contractor should understand **ALL** legal requirements of connection before undertaking any work or installation.

UNDER NO CIRCUMSTANCES UNDERTAKE THIS YOURSELF!!!

Note for electrician: This product comes with 13 amp plug (s) fitted with an RCD unit. We leave it this way for you to connect it your own way due to continued additions to current regulations.

- 1) Connect within current laws and IP directives.
- 2) (Preferred) Wire into isolated fused feed connecting directly to the house consumer/service box.

Always use protection against electrical surge. Your shower should be treated the same as a home computer. A surge protector should eradicate the possibility of either the transformer or control panel being burnt out.

Electrical work needs to be signed off by a fully qualified operative by law. Failure to adhere to this will not only void your electrical warranty for your shower, but could void your house insurance too.

Pressure/Water Requirements

We recommend a BAR pressure between 2.5 and 3.4 BAR. If you have a combi boiler system no problem should be experienced. If you have a gravity feed older type installation (hot water tank type usually less than 1 BAR) you will almost certainly need a pump. We cannot advise on which type of pump is used, location or design because all house plumbing layouts vary. This is a job for your installer/plumber. The end delivery however must fall within the scope above.

Important Note Do not exceed 3.4 BAR pressure under any circumstances. Warranty is void if so as damage will occur. If you have a combi supply, please use a pressure reducing valve if required to lower the BAR pressure to the shower.

Please Remember that this product is free standing and is designed to be pulled away from the wall.

The waste hose must be of a flexible type (1m flexible waste supplied).

The water supply pipes need to be at least 1 metre in length and must be that of a flexible braided type (not supplied).

DO NOT OVERTIGHTEN THE BRAIDED HOSES AS IT CAN CAUSE THE CONNECTION TO POP AFTER A FEW WEEKS OF USE.

Always fit easy to get to isolation taps on both hot and cold water supply (not supplied). Just like a dishwasher or washing machine, this product **MUST** be isolated when not in use.

Tools Required

You will require:

- Scissors
- Knife
- Silicone Gun
- Spirit Level
- Tape Measure
- Philips Screwdriver
- Electric Drill
- Safety Gloves
- Safety Glasses
- Silicone

Parts Required

- RubberGum (supplied)
- Plumbers Mait (not supplied)
- Hot and cold isolation valves (not supplied)
- 2 x Braided hoses (not supplied) **Steam version requires 3.**

What's in the Boxes?

Box	Contents	Quantity	✓
Tray	Shower Tray	1	[]
	Waste + Hose	1	[]
	Glass Shelf	1	[]
	Riser Rail for hand shower	1	[]
	Screw Pack	1	[]
	Flexible seal (12mm)	2	[]
	Shower hose	1	[]
Glass Room	Glass Doors	2	[]
	Front Fixed Glass	2	[]
Column	Complete Column	1	[]
	Hand Shower	1	[]
Backwalls	Left Back Panel	1	[]
	Right Back Panel	1	[]

Framework	Top Rail	1	[]
	Bottom Rail	1	[]
	Outer Fixed Uprights	2	[]
	Inner upright posts	2	[]
	Magnetic door seals	2	[]
	Rear flap door seals	2	[]
	Framework Securing Clips	4	[]
Roof	Roof with fittings	1	[]

Screw Pack Contents

Product Code	Description	Quantity
SP097	Door Handles	2
SP276	Twin Door Wheels Non-Push	4
SP276A	Twin Door Wheels Push button	4
SP072	Door stops	8
ST10	10mm Screws	8
ST16	16mm Screws	28
ST20	20mm Nut and Bolt	12
PRC20	Glass Retaining Clips	4
AMI01	Jubilee Clip (For steam version only)	1
SW9	Small Washers	20
DB9	Drill Piece	1

VERY IMPORTANT

Have you got everything? If not please contact the Insignia Support Line on **01908 226545**. Remember **NEVER** book your tradesman until everything has arrived, been checked and is present. No replacement/missing parts can be obtained free of charge during or after the build. Any claims can only be within the timescale permitted (48 hours after delivery) and always **BEFORE** build.

Step 1 — Level the Tray and connecting the waste

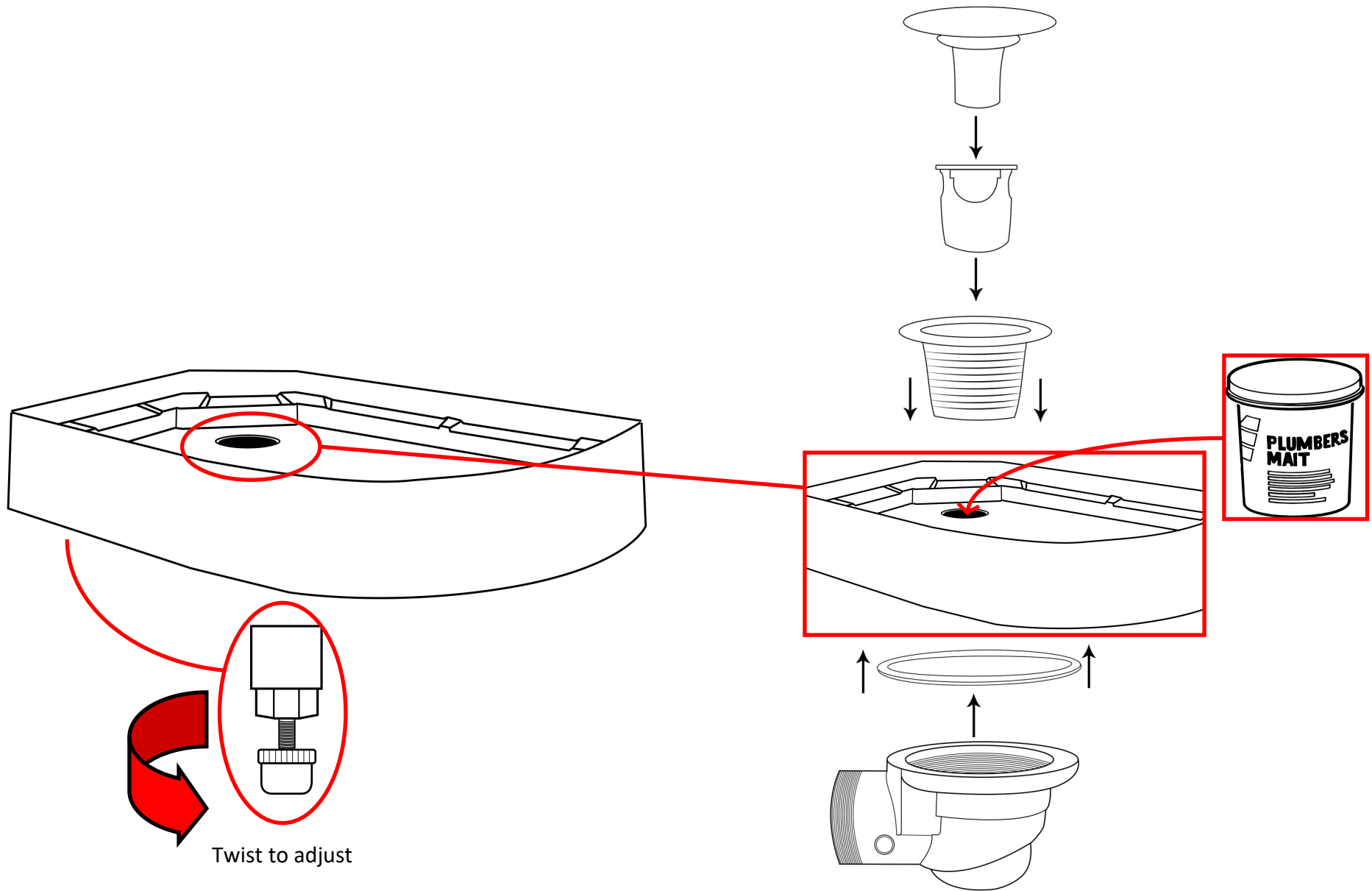

Step 2 — Connecting framework

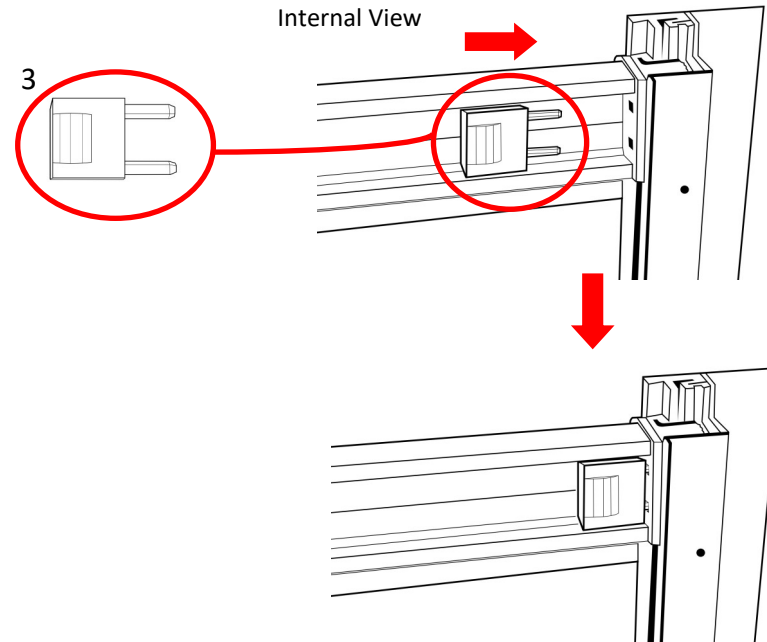
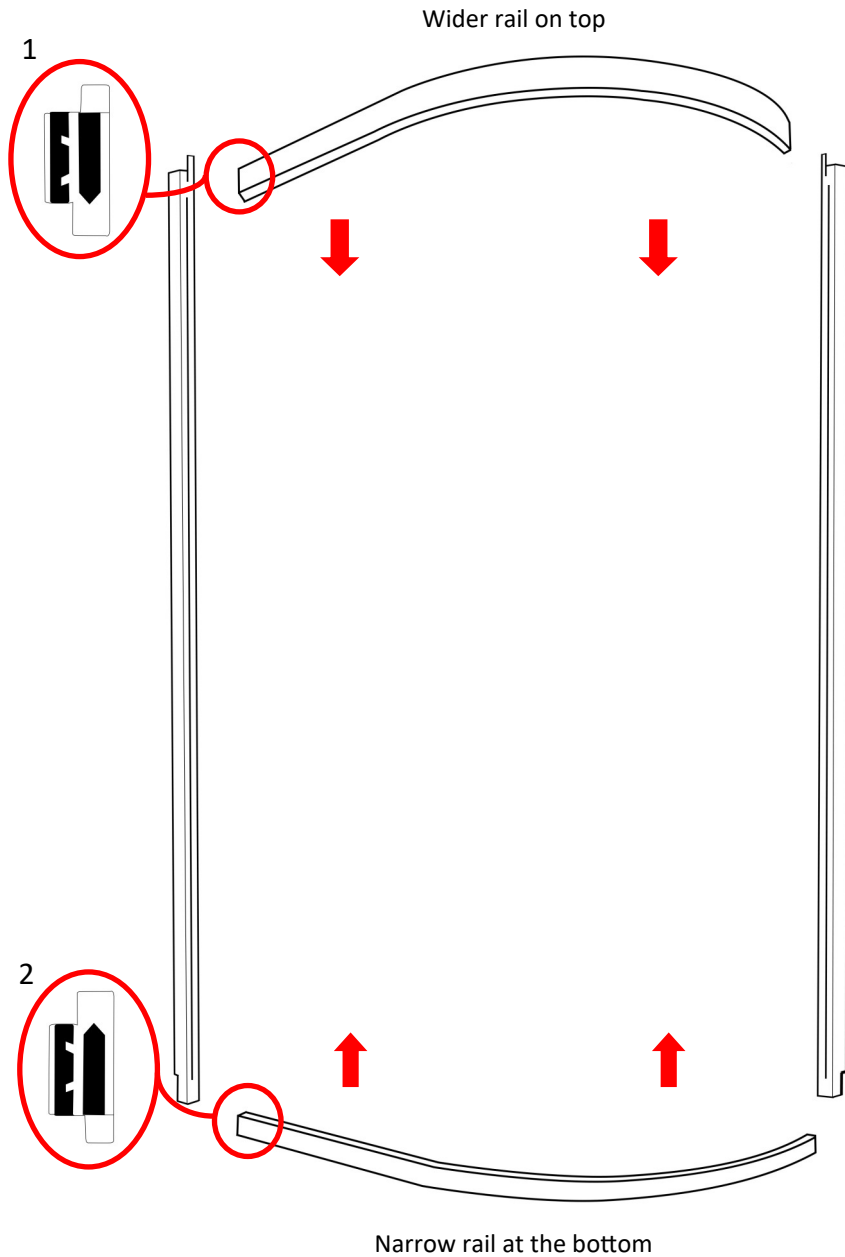

Step 3 — RubberGum the tray

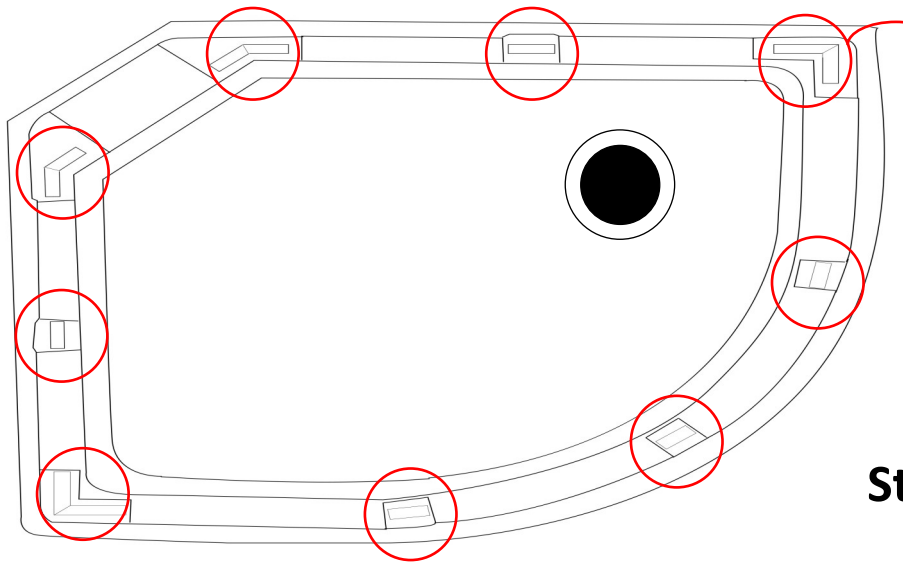

Apply RubberGum to raised sections of the tray and remove backing paper.



The image shows a black box of 'Insignia RubberGum Rubber Adhesive Sealing Seal' and a roll of white adhesive tape. The box has the text 'NEW', 'Insignia', 'RubberGum', 'Rubber Adhesive Sealing Seal', and 'Peel... Stick... Trim... Done!'.

Step 4 — Fix framework to the tray

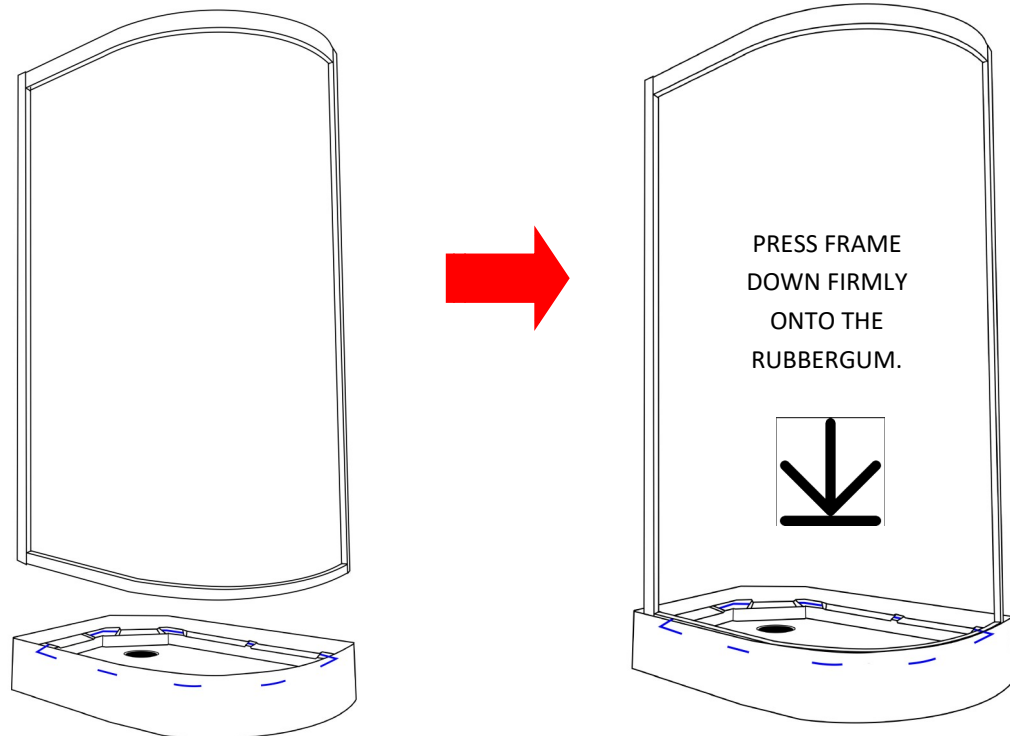

Step 5 — Connecting the back panels

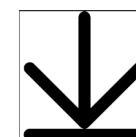
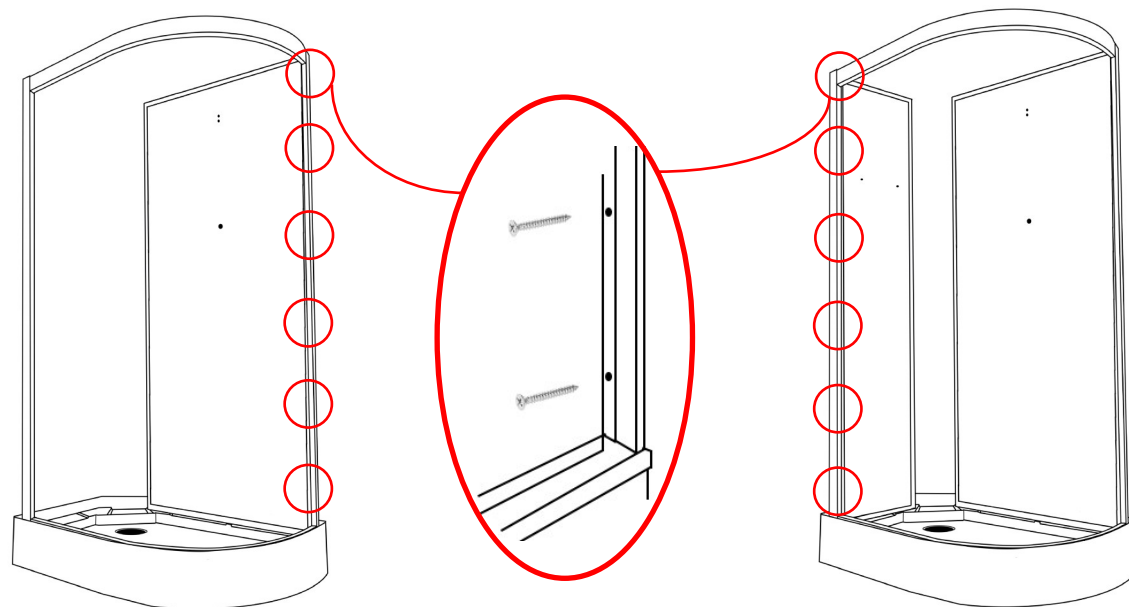

PRESS PANELS
DOWN FIRMLY
ON TO THE
RUBBERGUM.



DO NOT SCREW BACK PANELS TO THE TRAY.

Step 7 — Column Connection

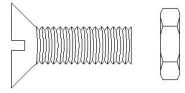

ST20 x 12



SW9 x 12

Rear View (attach nuts and bolts from rear)

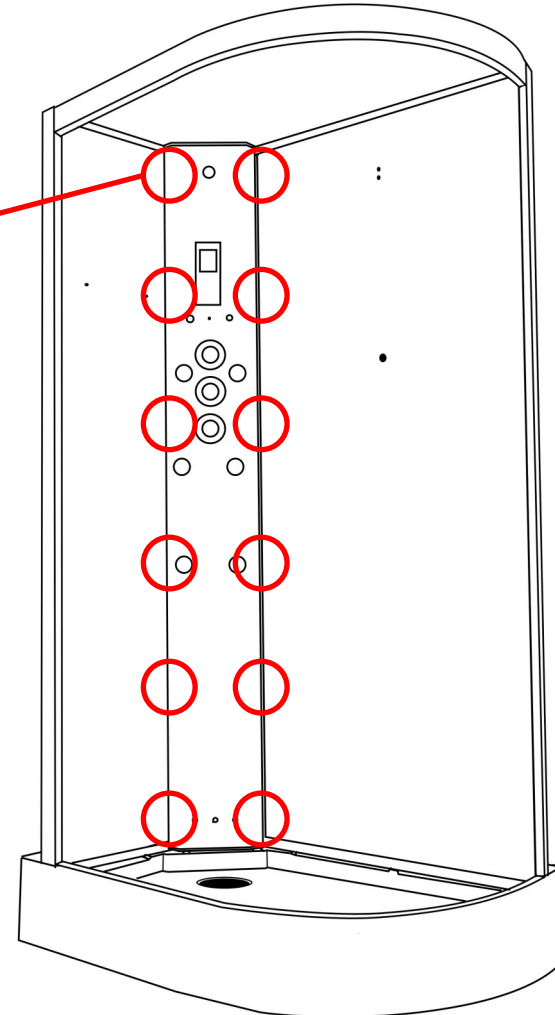
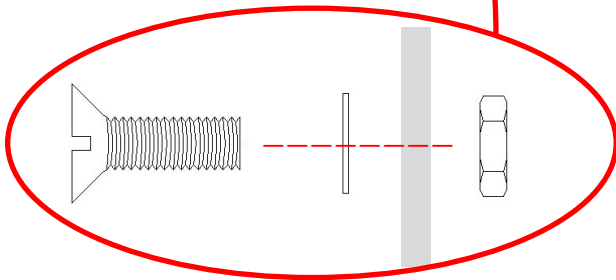
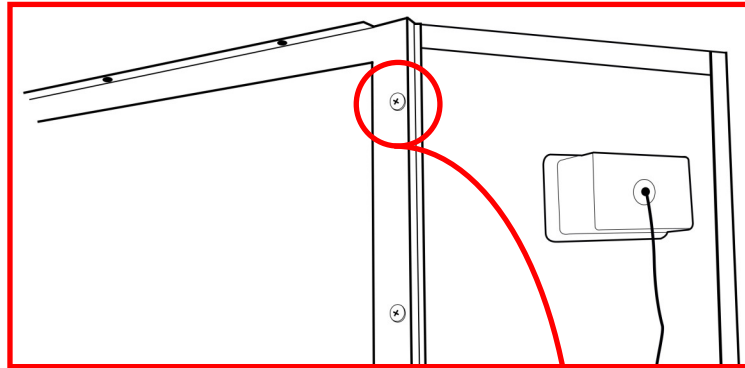

NOTE: Column features varies between models

Step 8 — Fixed Glass Connection

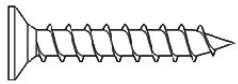

ST16 x 4



PRC20 x 4

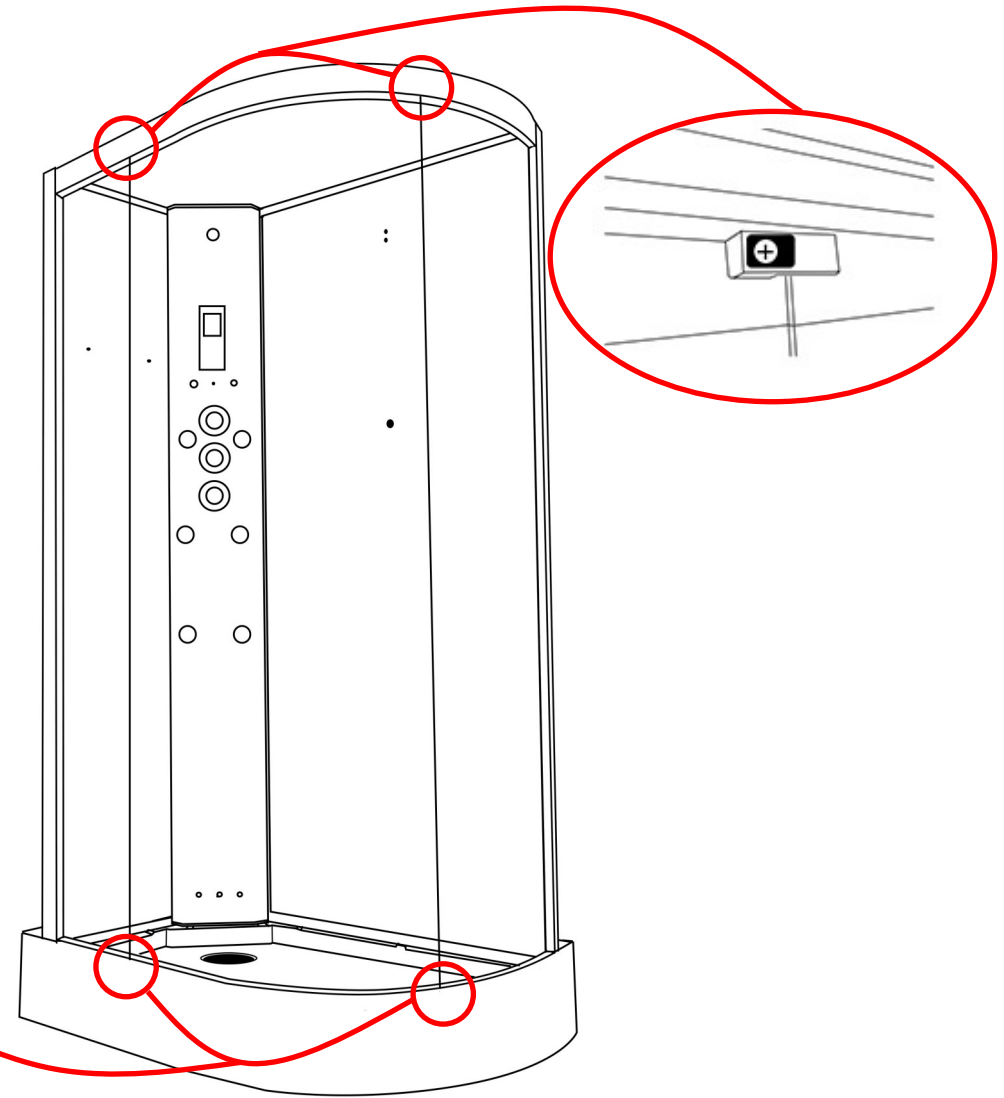
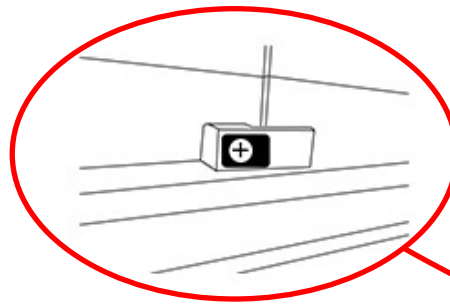
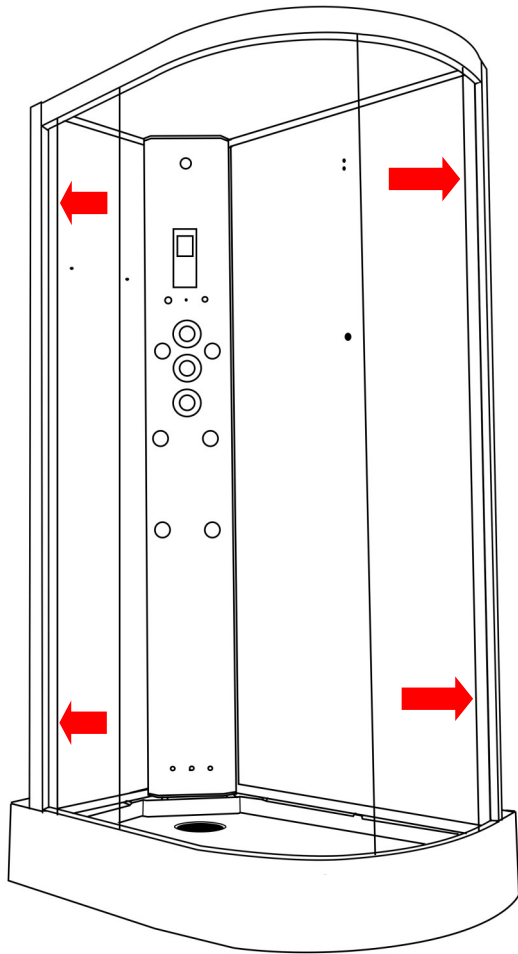

Step 9 — Fitting the glass seals

Fit seal inside the shower between the glass and framework

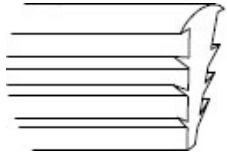

2x 12mm Seals

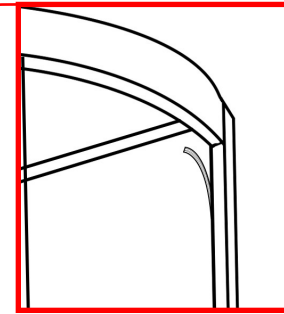
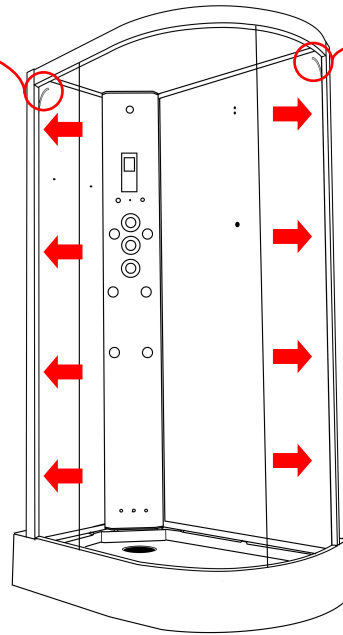
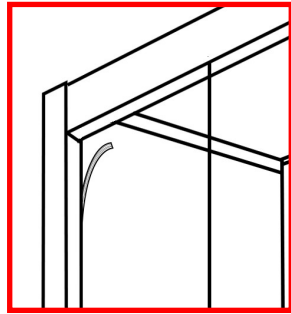

Step 10 — Fitting the door stops

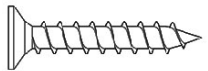

ST10 x8

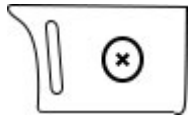

SP072 x8

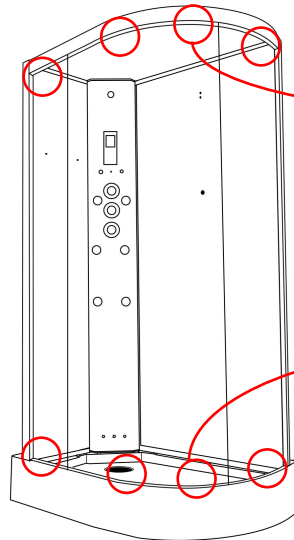

Internal View — Top Rail

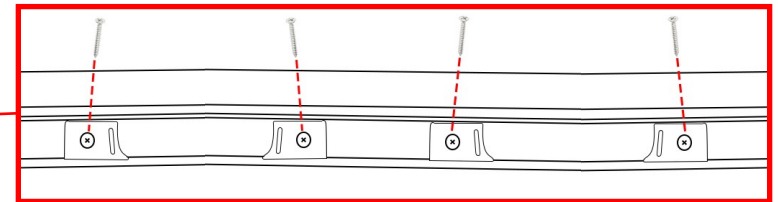
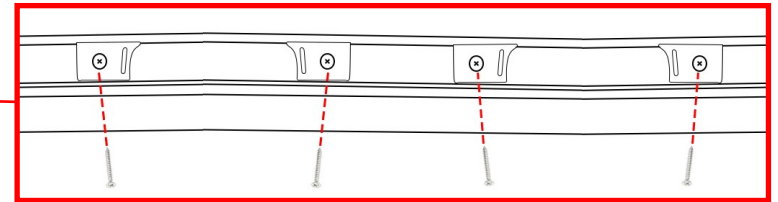

Internal View — Bottom Rail

Step 11 — Attaching the Roof

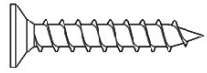

ST16 x6

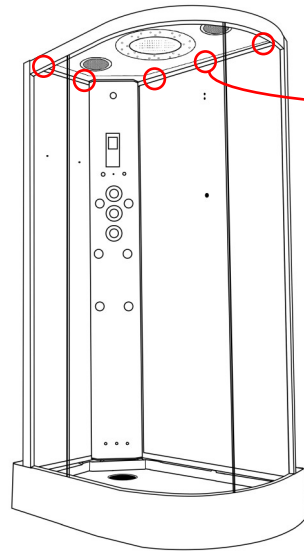
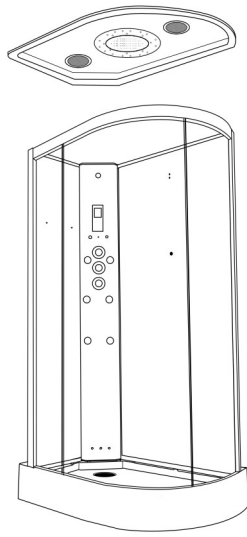

Screw from the rear

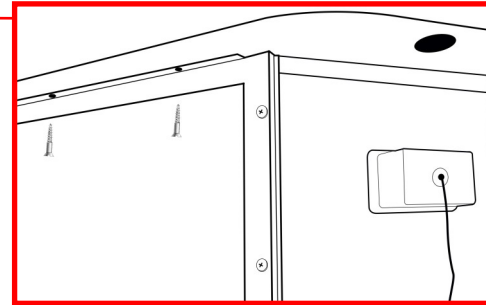

Step 12 — Fit door handles, seals and magnets

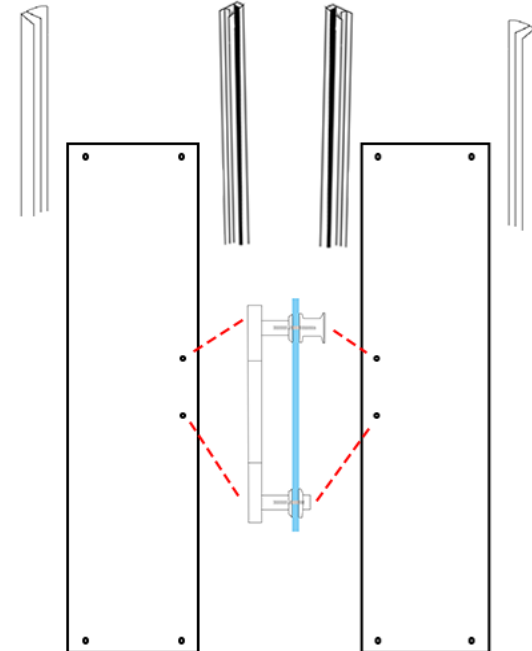
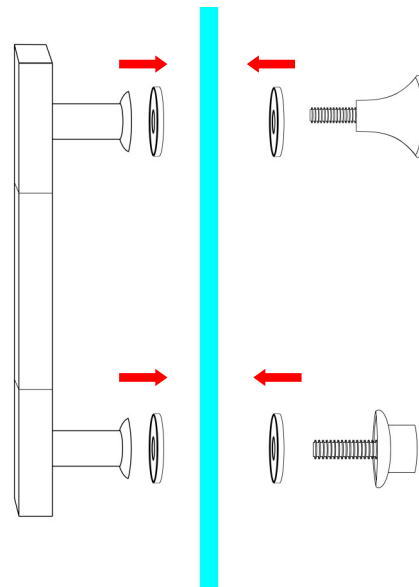

Step 13 — Fit top door wheels x 4

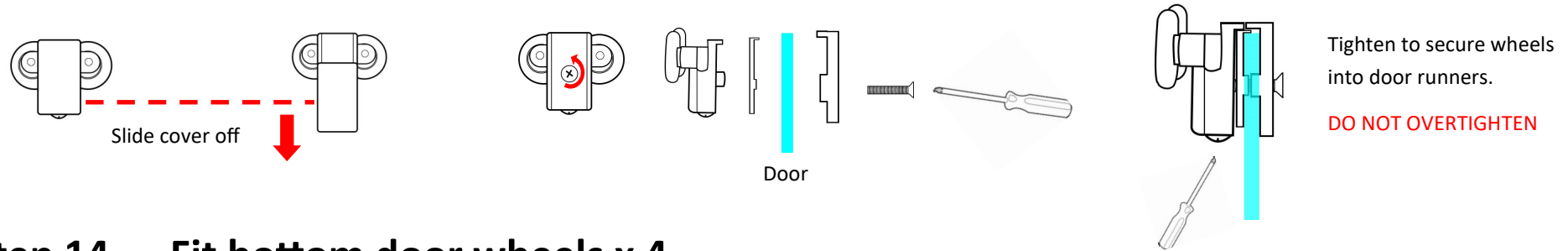

Step 14 — Fit bottom door wheels x 4

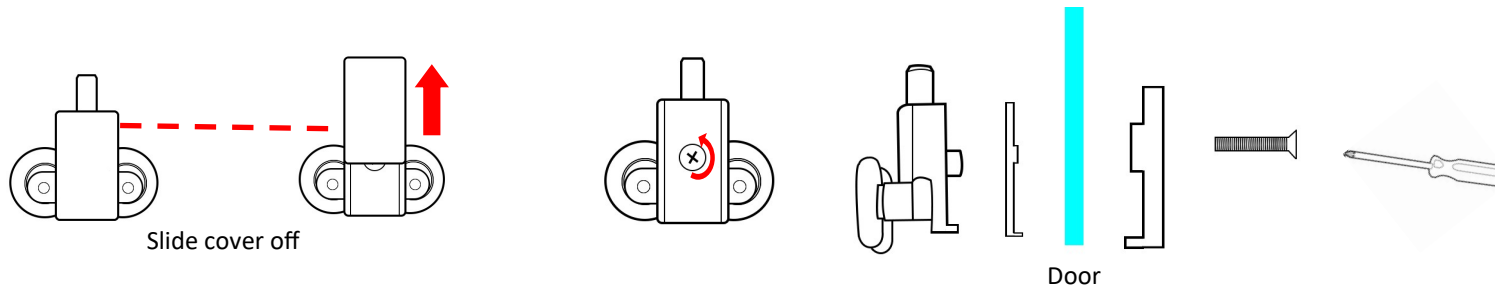

Step 15 — Fitting the doors

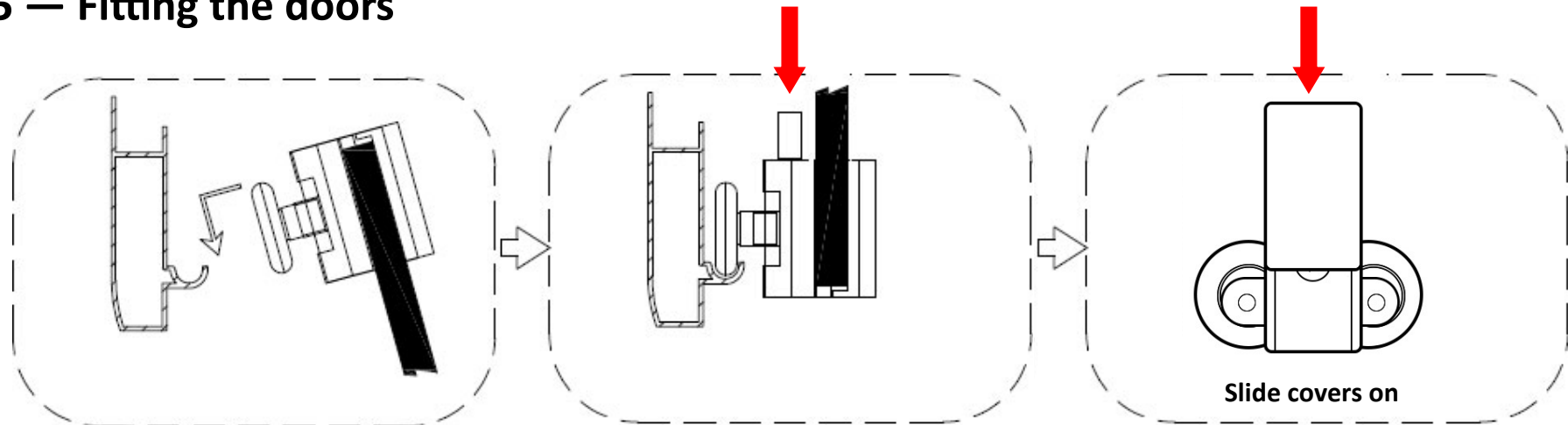

Step 16 — Accessory Installation

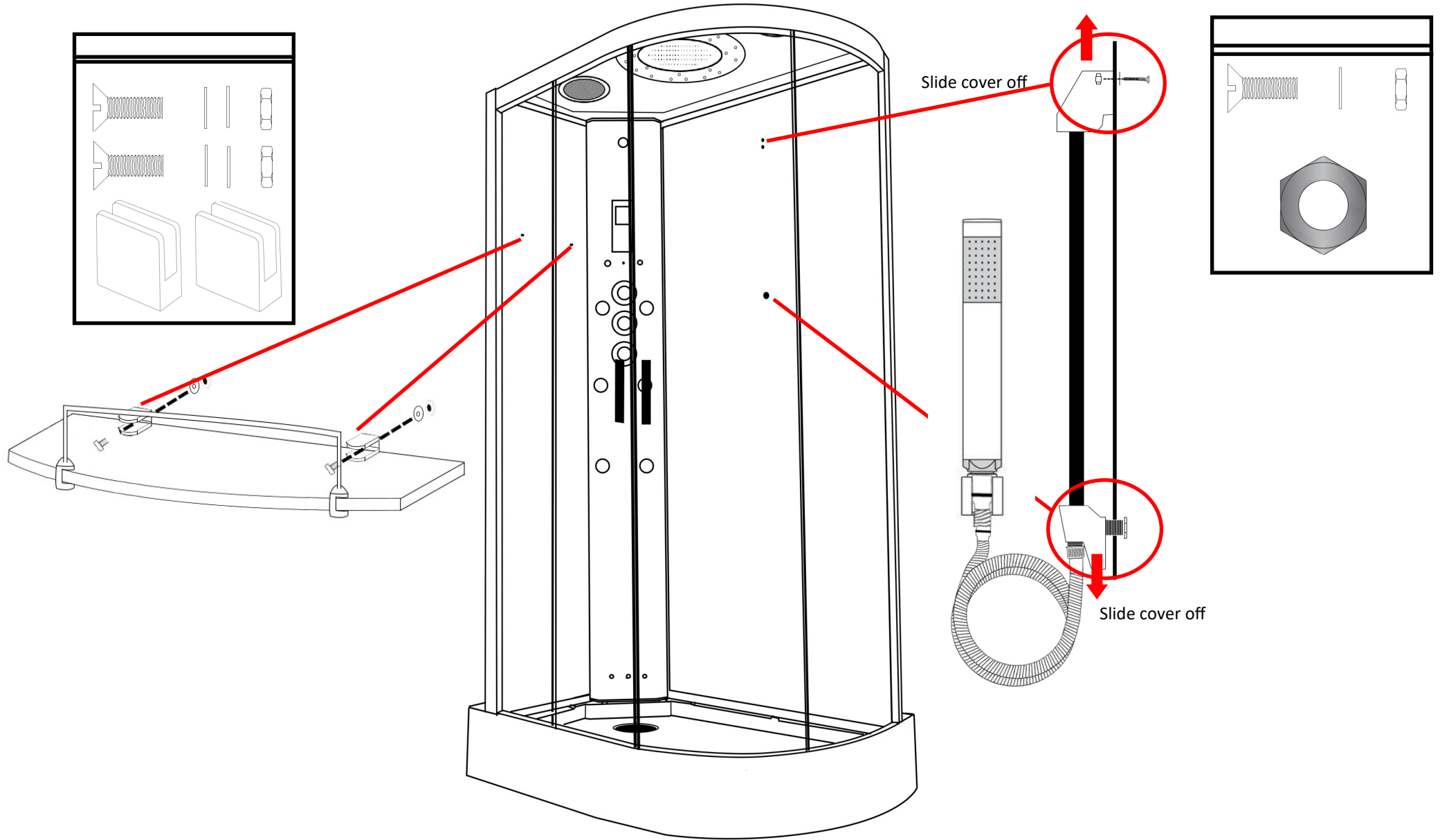

Step 17 — Valve/Water Connections

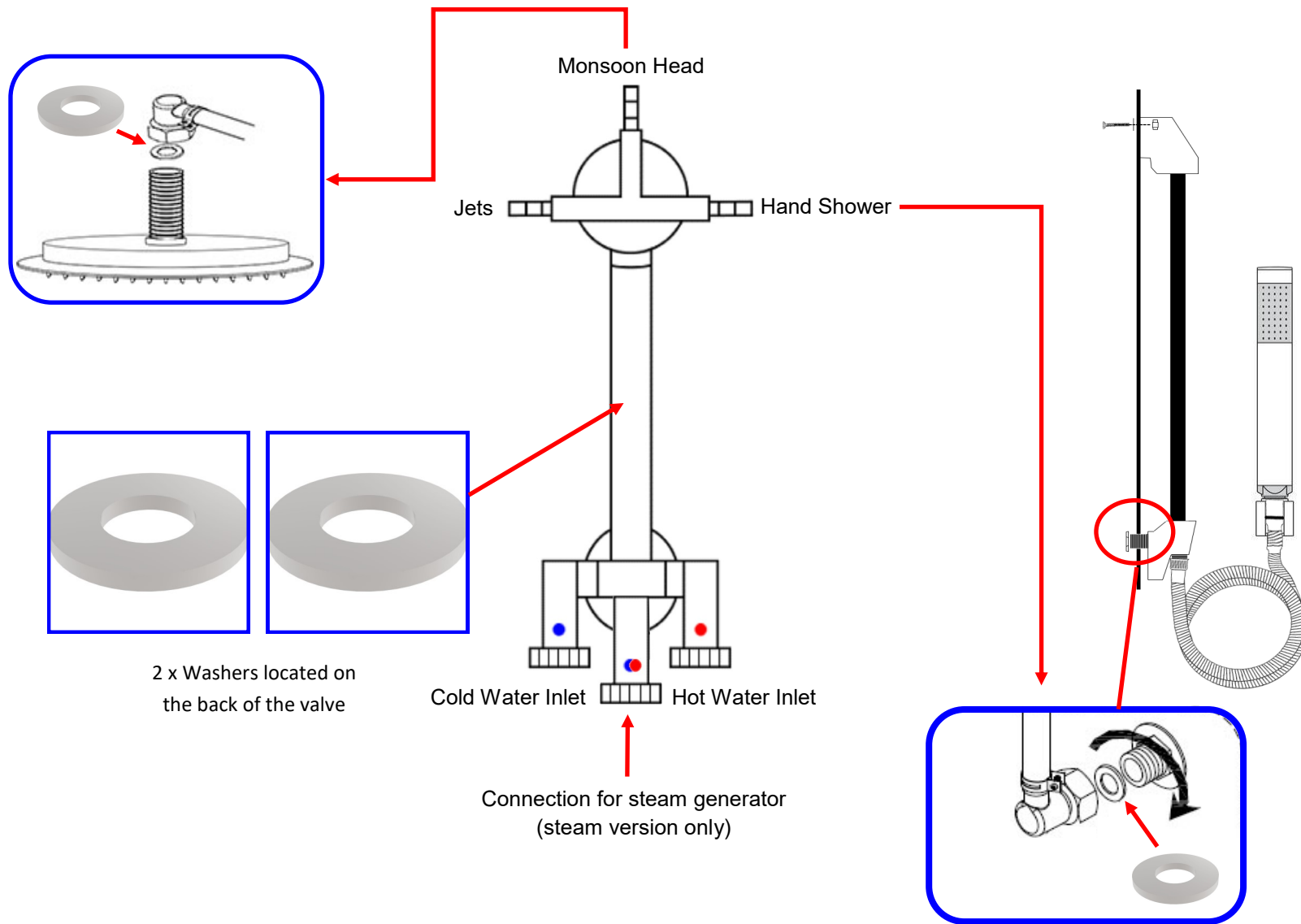

2 x Washers located on the back of the valve

Cold Water Inlet Hot Water Inlet

Connection for steam generator (steam version only)

Step 18 — Control Panel Connections

Platinum Steam Version

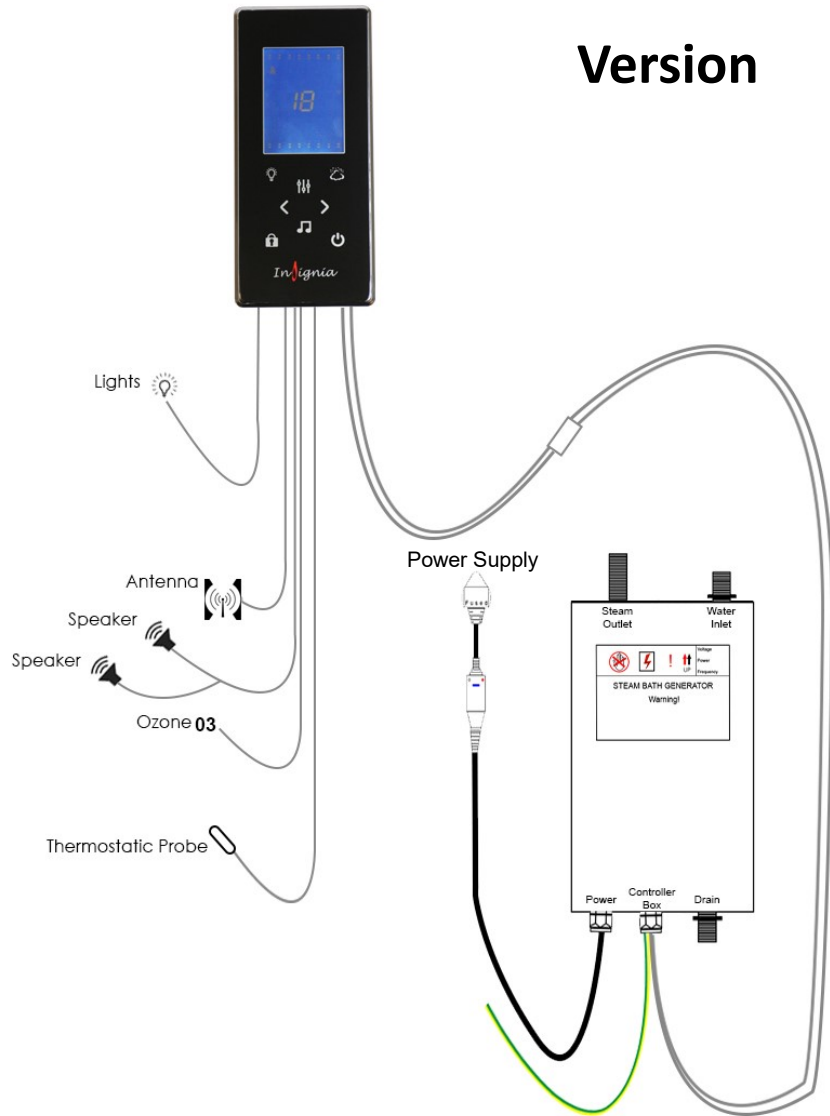

Platinum Version

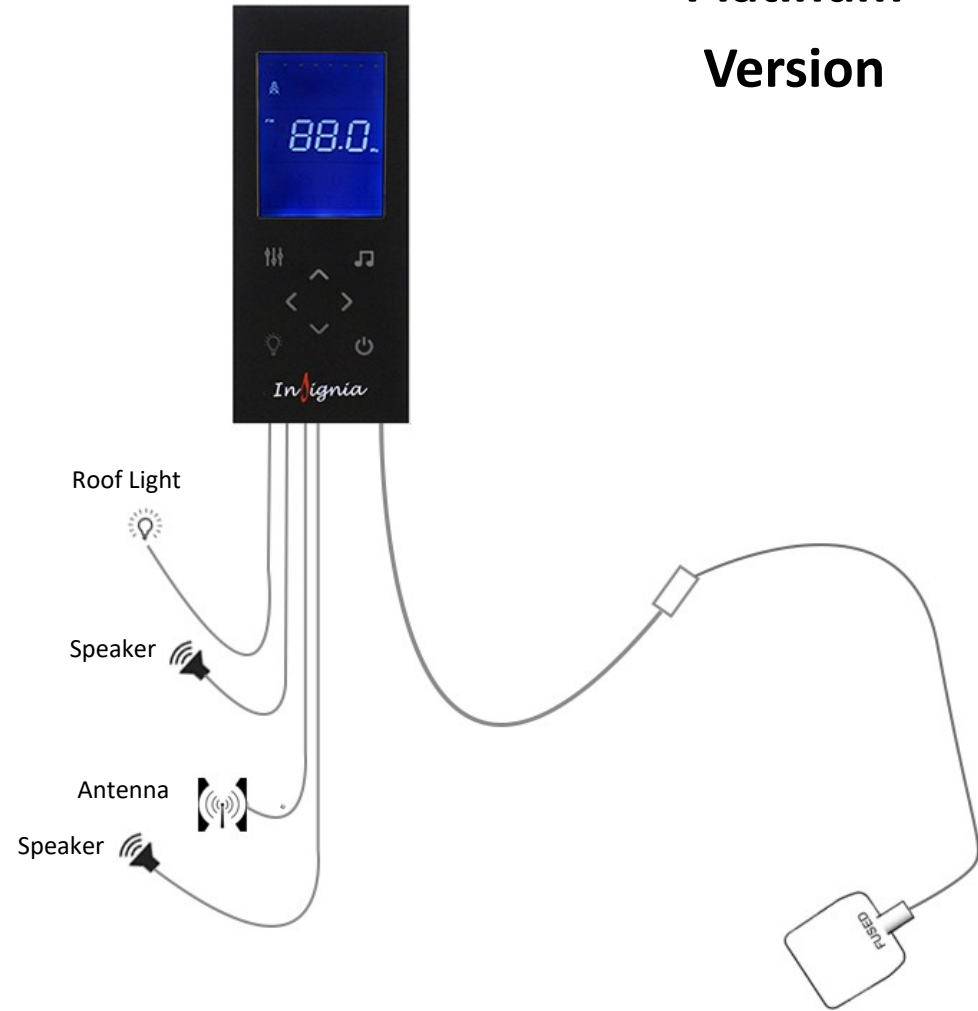

Steam Generator Connections (steam version only)

The steam generator has 3 connections.

1. **Steam Outlet:** Connect the white insulated hose to the steam outlet within your shower as shown in image **A**. Make sure these are fitted in the correct position as they are only attached for transportation reasons only.
2. **Water Inlet:** Connect a braided hose (not supplied) from the shower valve's centre feed to this opening.
2. **Drain:** Connect the grey rubber hose from the steam generators drain opening to the nozzle on the shower waste as shown in image **B**. Secure in place with the use of the Jubilee clip (AMI01) found in your screw pack Ensure you drill out the spigot to allow the steam generator water to drain in to the waste.

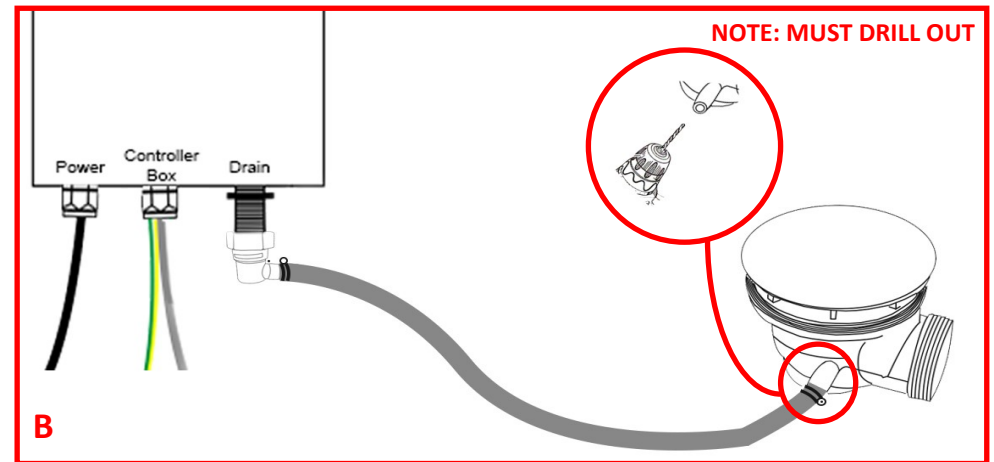
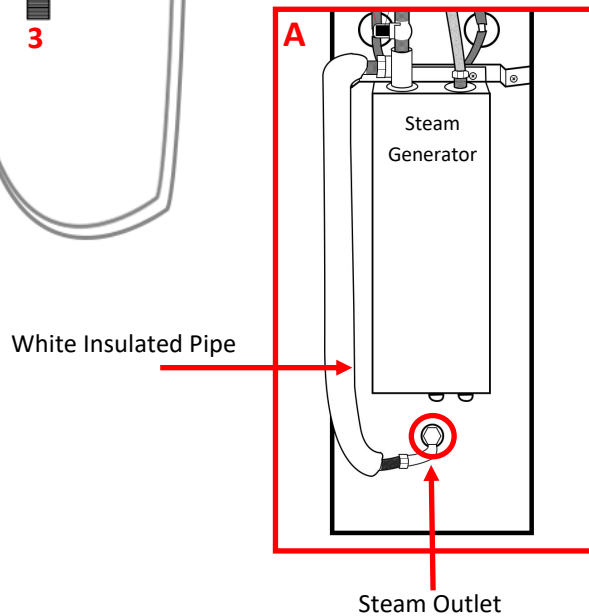
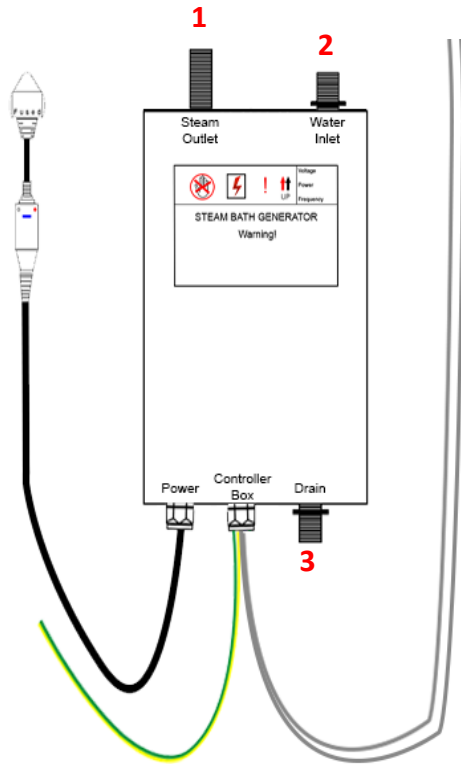

Signing off your shower

Now your shower is assembled, there is just few steps before you can sign the shower off.

1. Please ensure all the connections are watertight including the waste, body jets, internal and external hoses and steam connections (model dependent).

2. Once you are happy, check the shower functions by switching on the overhead shower and then adjust the selector knob (top knob) to the hand shower and then onto the body jets. Whilst the water is running, check external hoses for any signs or water drips or leaks and tighten accordingly.

Please note, when testing the body jets, water will shoot towards the open doors and the user.

3. Do not aim the hand shower directly at the joints of your shower as this does not fall under “normal showering conditions”. However, due to Insignia’s unique design of the shower tray, water will only leak back in to the tray so you won’t get flooded.

4. Visually check the water flow in to the waste and adjust the feet of the tray accordingly to ensure the direction of the water flows towards to the waste to prevent over puddling (a small amount of puddling is normal).

5. Never use the shower until all checks have been made and the installer is 100% happy in the knowledge no hose leaks are present.

7. Any Rubbergum which has squeezed out between the panels and the tray, simply cut off using a sharp, clean knife blade.

6. Now push the shower from it’s base into it’s final position. **NEVER PUSH THE GLASS OR FRAME** into its final resting position.

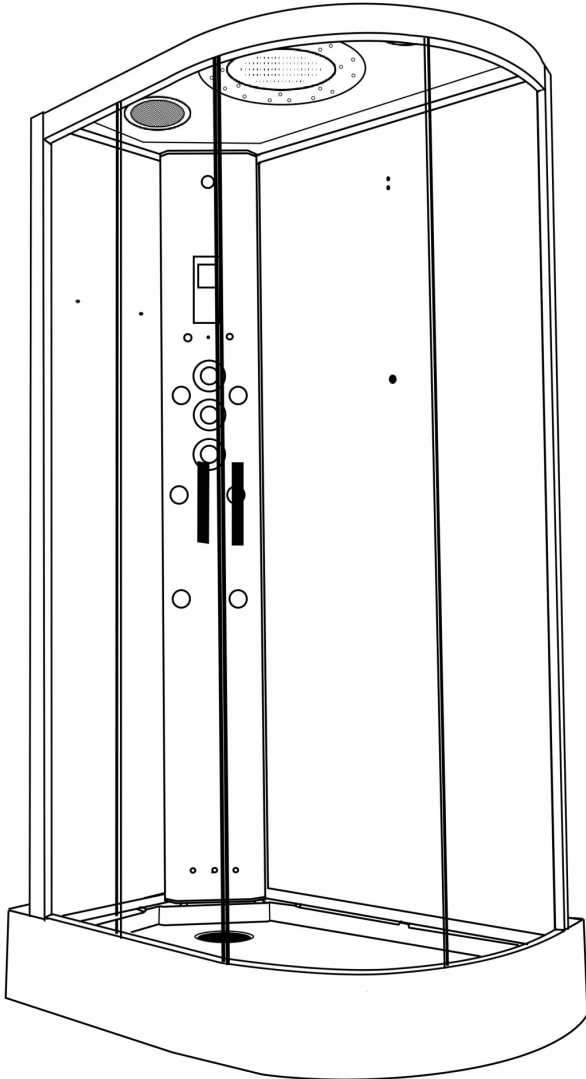

Happy Showering!

Control Panel Instructions (steam version only)



Button 1 (Lights)

Once the control panel is switched on, the lights will come on automatically. Press the Light button once and the lights will start to scroll through the multiple colour options. Then to stop the lights on a specific colour simply press the light button again on the desired colour. To turn the lights off press the light button again.

Button 2 (Steam)

To start the steam function, simply press the steam button (which looks like a cloud). To set the time and temperature of the steam session, simply press the mode button (button 3) and then use the arrows to scroll up and down (button 6)

Button 3 (Mode)

This will do nothing on start-up, however it will be your go to button when using steam, radio and Bluetooth options

Button 4 (Padlock)

This is your unlock button. After twenty seconds of inactivity the steam function will lock on the panel. This is done as a safety feature, so it can't be accidentally activated. Other buttons will remain functional whilst in this state of 'lock mode'

Button 5 (Music)

Press once for FM Radio and press twice for Bluetooth. For tuning radio stations or connecting Bluetooth, please see the next page. For volume control, once on the radio or Bluetooth setting press Mode (button 3) then use the left and right arrows to change the volume. The volume is denoted by a number followed by the letters 'db'

Button 6 (Left and Right Arrows)

This will do nothing on start-up, however they are multi-functional depending on what setting you are using. When in the radio setting you can use them to change the station. When using the Bluetooth setting you can skip forward or back tracks in your playlist. You can also control the volume with these arrows as directed above.

Button 7 (Power)

Press once to turn on the panel. Simply press again to turn it off. When powering down the O3 will automatically start and last for approximately 10 minutes. After this the screen will power off.

To see our tutorial videos for operating this control panel's features, please search for "Insignia Showers" on YouTube and find our "SUN Control Panel" Playlist, or you can [click here](#)

Control Panel Instructions



Button 1 (Radio Search)

With the Radio function active, hold for approximately three seconds to automatically tune you radio

Button 2 (Mode)

Press x1 to turn on the radio

Press x2 to activate the Bluetooth

Button 3/7 (Audio Volume)

Press up or down to increase or decrease the volume in the cabin.

Button 4/5 (Skip button)

Press to skip radio station on the radio setting. When the Bluetooth is activated this will skip to the next song in your playlist.

Button 6 (Lights)

Press to activate or deactivate the lights.

Button 8 (Power Button)

On/Off.

To see our tutorial videos for operating this control panel's features, please search for "Insignia Showers" on YouTube and find our "SUN Control Panel" Playlist, or you can [click here](#)

Control Panel Instructions

Connecting to Bluetooth



Step 1

To connect a device via Bluetooth, press the music function button twice (which looks like a musical note) the control panel will then show "INS".

Step 2

Then simply go on your device and pair up with the shower which should be shown as "INS". Once this is complete you will hear a beep to signify you're connected and ready to listen to any music of your choice.

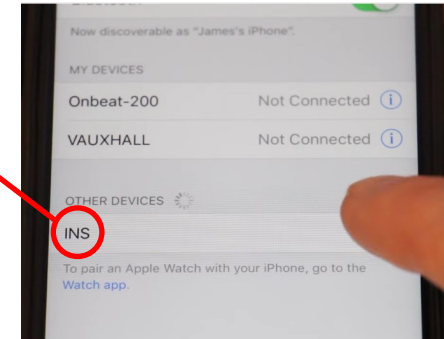

Tuning your radio channels



Step 1

To tune your radio channels firstly press the music function button (which looks like a musical note)



Step 2

Then once the radio is on press and hold the mode button until it starts scrolling.



Step 3

Finally, once the panel has finished scrolling then use the left and right arrows to cycle through all the radio stations that were found.

Parts List

Internal Items

Part Code	Part Description
SP170	Monsoon Shower head
SP078	Ozone Module
SP174	Round Body Jet (Two Open Ends)
SP174a	Round Body Jet (One Open End)
SP236 SP112 (warranty) SP120 (warranty)	Complete riser bar Shower holder (for riser bar) Water Inlet (bottom part of riser bar)
SP142	Shower waste
SP097	Chrome rectangular door handles
SP190	Glass Shelf
SP196	Thermo sensor holder
SP072	Door stoppers
SP276	Twin Door Wheels Non-Push
SP276A	Twin Door Wheels Push Button
SP034	Tri-Jet system
SP105	Chrome Flexible Hose
SP060	Electrical extension cable
SP270	Chromotherapy Lighting
SP036	Speaker
SP228	Speaker cover
SP211	12V Transformer

SP200	Insignia Control Panel
SP117	Insignia Control Panel (steam version only)
SP227	Microphone Style Hand Shower
SP194	Fixed Glass Seals (12mm)

External Items

Part Code	Part Description
SP300	Waste hose
SP301	White insulated pipe
SP221	Drain Hose
SP234	Vertical steam generator/Electric box
SP308	Magnetic door seals
SP310	Rear door seals
SP173	3 port—3 feed thermostatic valve
SP095	3 Port Selector Cartridge
SP044	On/Off Water Mixer Valve
SP182	Vernet Screw Fit Thermostatic Cartridge
SP043	Plastic Thermostatic Valve Safety Lock Ring

All images are registered with
ImageTraker

Insignia™ is a registered trademark of Maclean International Ltd

All images are subject to copyright. Images may not be used in any way shape or form with out written permission from Maclean International Ltd. Images are NOT permitted to be saved, printed or uploaded. Violation of copyright laws are punishable by law.