

# IMPERIAL

## Pan Connector Instruction Guide

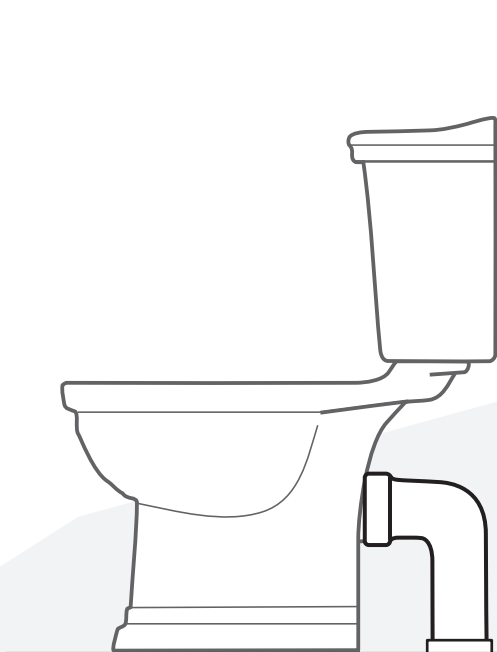

**Important Information:**

Please check the products for transport damage and that contents are complete before installation.

Consult a qualified plumber if you have any problems installing this product.

Complaints made following installation regarding the above cannot be accepted.

## Installation Guide

Thank you for purchasing this Imperial product.  
These instructions relate to the products shown below.  
Before you start check you have the necessary tools for installation.



Before you begin:

**Always handle our products with care and attention.**

**Ceramic products are brittle, and may chip, crack or break if not handled carefully.  
Broken ceramic is extremely sharp.**

Take care not to over tighten screws and fittings. Over tightening may lead to breaks or chips in the ceramic. Before installing the product, please inspect for damage incurred during transport. Imperial can not take responsibility for damaged products after or during their installation.

We recommend that the guidance of a qualified plumber is sought throughout the installation process. Always observe the plumbing and building regulations in the area the product is being installed in.

Imperial reserves the right to amend the design of its products without notice, as specified in the company catalogue.

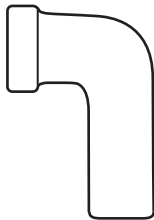

Ceramic 90 Degree  
Pan Connector

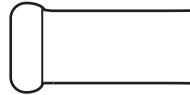

Ceramic Straight Pan  
Connector 236mm

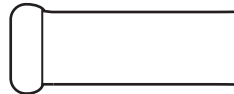

Ceramic Straight Pan  
Connector 330mm

## Tools Required

The following tools are necessary for the installation of this product.  
Imperial would once again recommend that a qualified plumber carry out the installation of this product.



Pencil

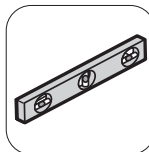

Spirit Level

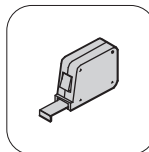

Tape measure

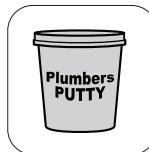

Plumbers putty



Silicone Sealant

To install the ceramic connector:

1. Install WC pan as directed by instructions provided.
2. Measure and plan the connection to be made from the WC outlet to the soil pipe.
3. Place ceramic connector and shroud ring over the WC outlet and into soil pipe.

**⚠ NOTE:** It may be required to cut into floor boards/walls. If this is required ensure to check for hidden pipes and cables.

4. Using plumbers putty create a secure seal.
5. If desired finish off the seal with a thin bead of white silicon.



**⚠** Imperial recommends to use Plumber's mait.

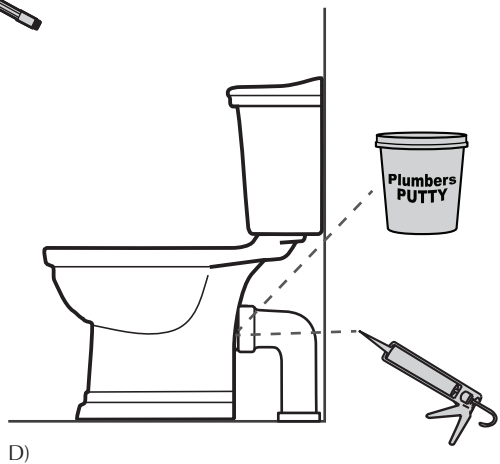
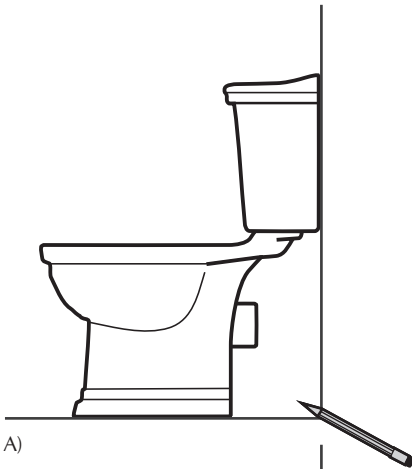

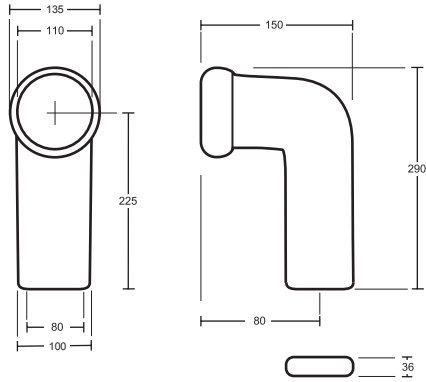

Ceramic 90 Degree  
Pan Connector

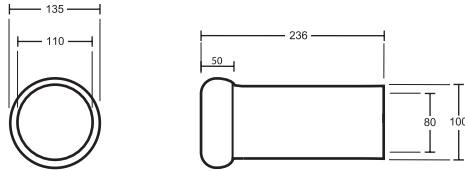

Ceramic Straight Pan  
Connector 236mm

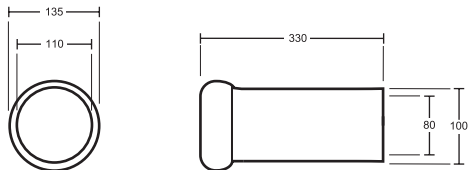
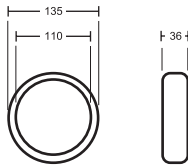

Ceramic Straight Pan  
Connector 330mm

