

# Installation Manual

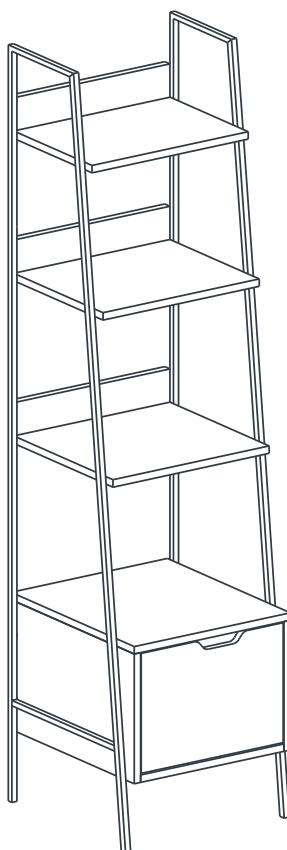

# Tools List



$\phi 8$



$\phi 8$

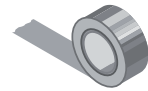
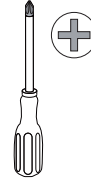

# Parts List

## Fixed System1

### Side Cabinet

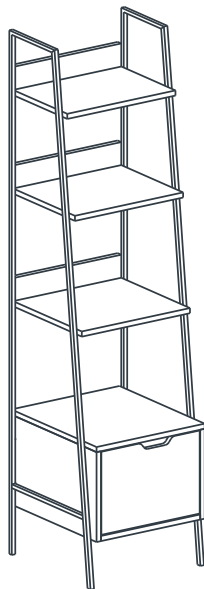

### Fixed Accessories

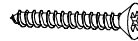

A- $\phi 4 * 50$



B- $\phi 4 * 70$



$\phi 8 * 40$

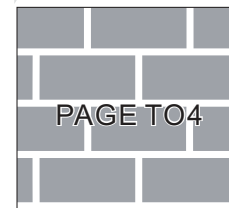

PAGE TO4

1

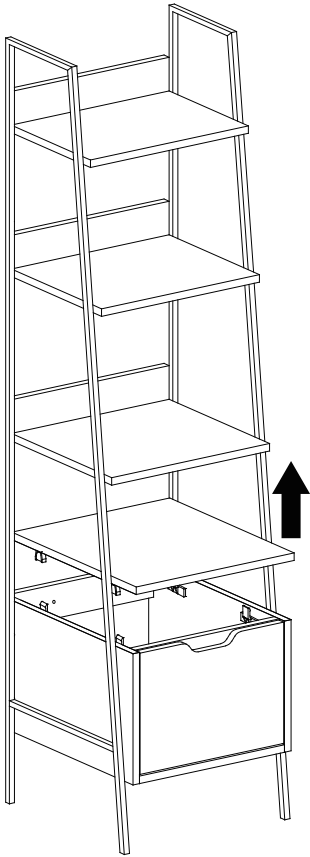

2

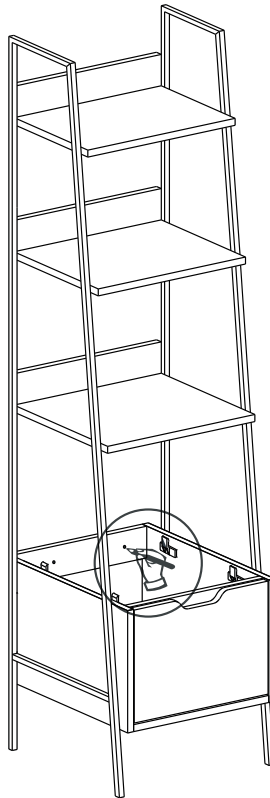

Screw position

3

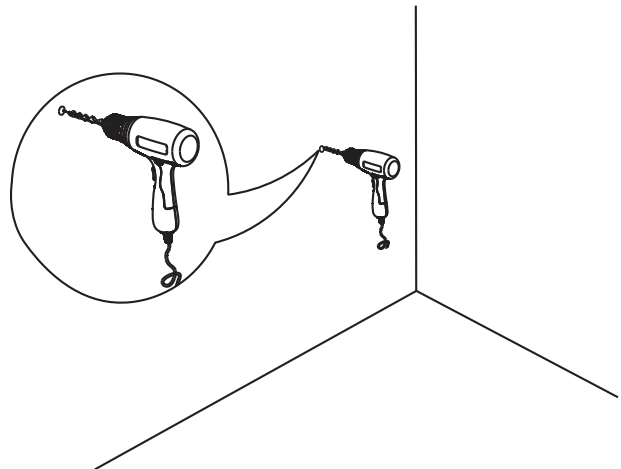
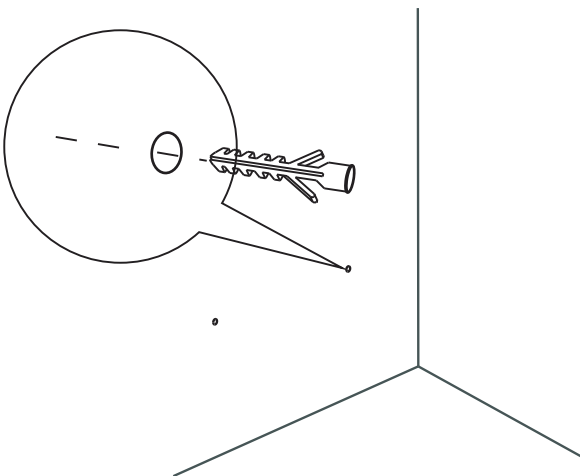

4

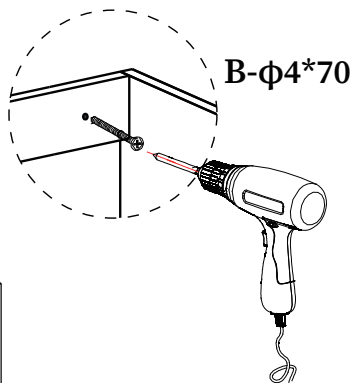
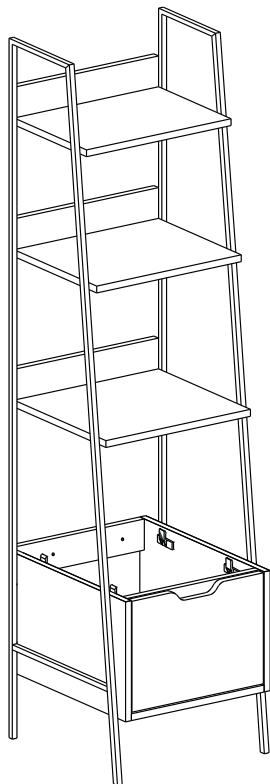

5

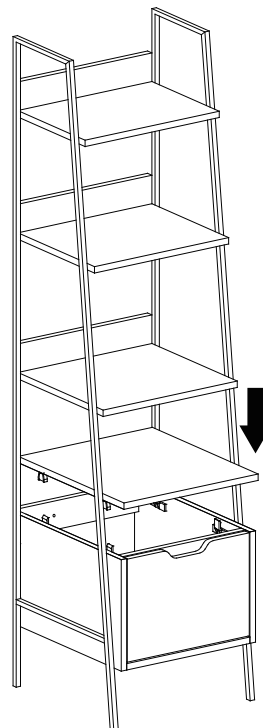

6

