

INSTALLATION
INSTRUCTIONS

CODE: SE30014W0/SE30022W0

IMPORTANT: Please read these instructions before commencing installation and retain for future reference.

Components

Tools required

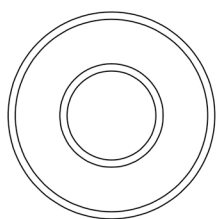

1 x SE30014W0/SE30022W0 Ceiling Light

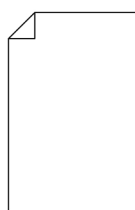

1 x Instructions



73mm Hole Opener

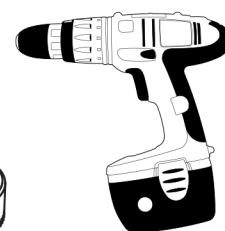

Power Drill

Important Safety Information

Please read these instructions carefully before attempting to install this product. It is advisable to keep these instructions in a safe place for future reference.

We recommend that you consult a qualified electrician. All electrical installation must be carried out in accordance with current IEE wiring regulations (BS7671).

These products must not be modified, if any modifications are made, it may invalidate the warranty and may render the product unsafe.

Do not install the luminaire close to flammable materials and do not under any circumstances cover with any insulation material.

- This product is IP65 Rated.
- Always switch off the mains supply before servicing, fitting or replacing lamps.
- Always check the lamp is correct for the application including its wattage and voltage.
- Special attention should be made to any installations with low ceiling voids.
- Never exceed the maximum wattage.
- Ensure the lamp is correctly installed into the lamp holder.
- 0.5m is the minimum distance between the fitting and lighted objects.

Please note, there must be at least 0.5m distance between the front of the luminaire and the nearest illuminated surface. Do not install this product into new plaster or damp areas.

Safety Instructions

1. Before commencing installation or maintenance, isolate the main electrical supply for the appropriate circuit at the fuse board.
2. This product is only suitable for connecting to a 240V 50Hz supply.
3. The lights should be recessed into a secure surface.

4. Suitable for furniture lighting.

Waste Electrical & Electronic Equipment (WEEE)

The symbol on the product, or on the document accompanying the product, the crossed out wheellie bin symbol, indicates that this product may not be treated as household waste. Instead it shall be handed over to the applicable collection point for the recycling of electrical and electronic waste.



RoHS
Compliant ✓



Installation

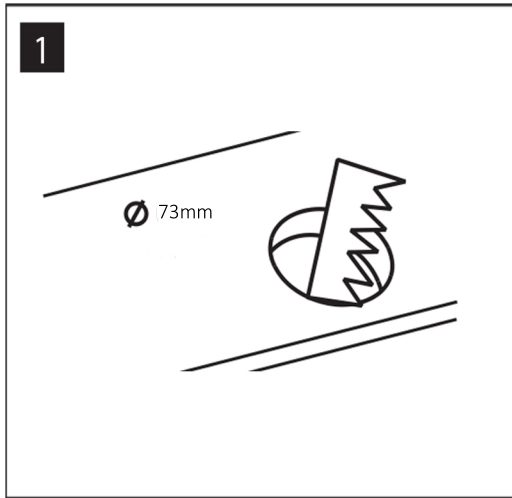

Check that the correct lamp type and wattage is fitted. The lamp supplied with this pack is correct. Select the required position, beware of joists, water pipes and electric cables. Cut a 73mm hole in the ceiling.

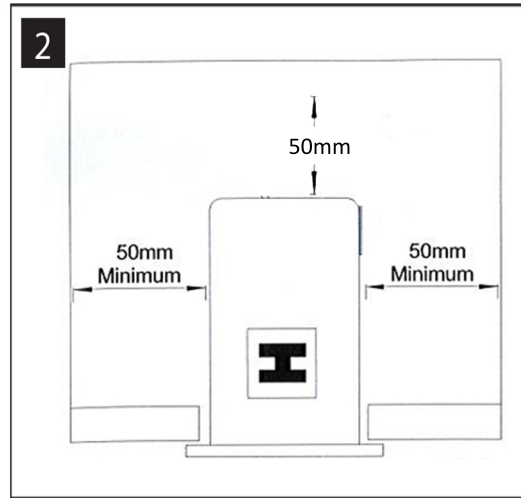

Please see above diagram for clearance measurements. To meet "Part C" of the building regulation's and to provide sufficient air-tightness, a seal is fitted in front of the bezel ring. This avoids the occurrence of condensation forming in cold un-vented roof spaces.

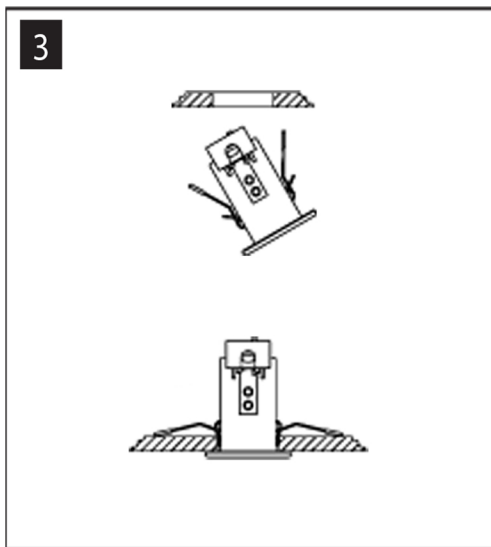

Insert the light into the hole cut, allowing the legs to clip back onto the ceiling to create a secure fitting. Then connect the product to a mains 240V supply.

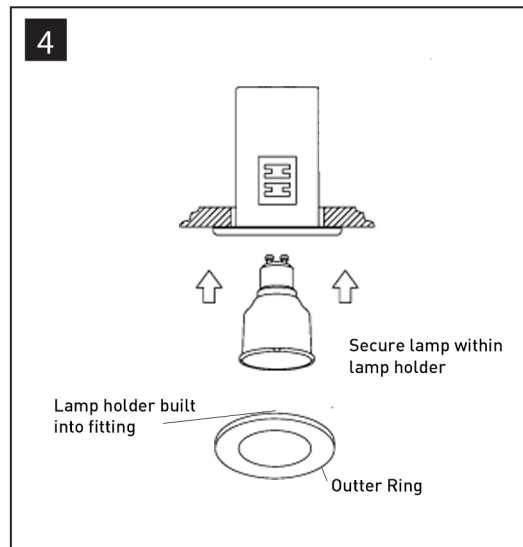

Insert the lamp into the front ring. Then secure the lamp within the lamp holder that is built into the fitting- as shown in figure 4. The electricity supply can be turned on.

Maintenance & Care

- Ensure that the power is disconnected prior to cleaning.
- To keep the finish of this product, wipe over with soft cloth periodically.
- Do not use harsh chemical solvents, it may dis-colour or damage the finish.