

HERITAGE

BATHROOMS

Installation Guide



Models Covered:

Salcombe Basin Mixers

**TSACC04, TSACBB04,
TSACBL04, TSACCT04,
TSACBBT04, TSACBLT04**

Please keep this booklet for future reference.

Installer: When you have read these instructions, please ensure you leave them with the user.

INTRODUCTION

Thank you for buying a Heritage Product. When you buy a Heritage product, you can be confident that it not only features a beautiful, distinctive, classic design, but that it has also been made to the very highest quality standards.

To ensure that it works to its full potential, it needs to be fitted correctly.

These fitting instructions have been created to give you all of the information you need and, if you need any further help, please do not hesitate to give us a call on: 0330 026 8503.

CONTENTS

SAFETY NOTES	3
SPECIFICATION	3
PACK CONTENTS	4
TOOLS REQUIRED	5
INSTALLATION - BASIN MIXER	6
INSTALLATION - TALL BASIN MIXER	7
MAINTENANCE	8-9
TROUBLESHOOTING	10
CARING FOR YOUR PRODUCT	11
GUARANTEE	11
NEED HELP?	11



SAFETY NOTES

All products manufactured and supplied by Bristan are safe to use provided that they are installed, operated and receive regular maintenance in accordance with these instructions.

This product needs to be installed in accordance with, and meet the requirements of the Water Supply (Water Fittings) Regulations 1999 and current by-laws.

Isolation valves must be fitted to the inlet water supplies to ensure ease of future maintenance. Before installing this product the water supply must be thoroughly flushed in order to remove any swarf, solder etc. Full access must be made available for future maintenance/servicing purposes.

This product must not be modified in any way as this will invalidate the guarantee.

If in doubt, contact a registered plumber, your Local Water Authority or the Secretary of the Institute of Plumbing, address as follows:-

The Institute of Plumbing,
64 Station Lane,
Hornchurch,
Essex,
RM12 6NB, Tel: 01708 472791

SPECIFICATION

OPERATING PRESSURE RANGE (BAR): Min 0.5 bar, Max 5.0 bar

MAXIMUM STATIC PRESSURE (BAR): 10 bar

INLET WATER TEMPERATURE RANGE: Hot - Max 65°C

INLET CONNECTIONS: 1/2" BSP Flexible Tails

Note: When installing flexible tails screw in by hand, DO NOT OVERTIGHTEN. Also ensure that there are no kinks or twists in the flexible tails when connecting to prevent water supply issues.

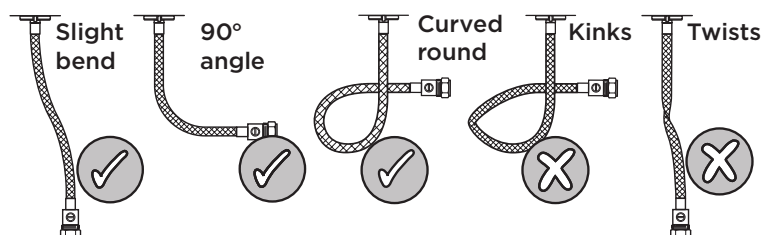

PACK CONTENTS

Basin Mixer

300mm;
285mm
length
available
once
screwed in

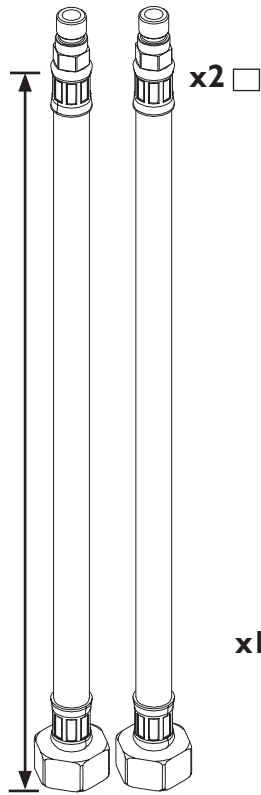

x1

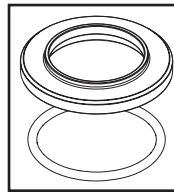

x1

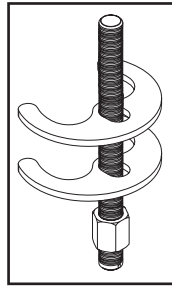

x1

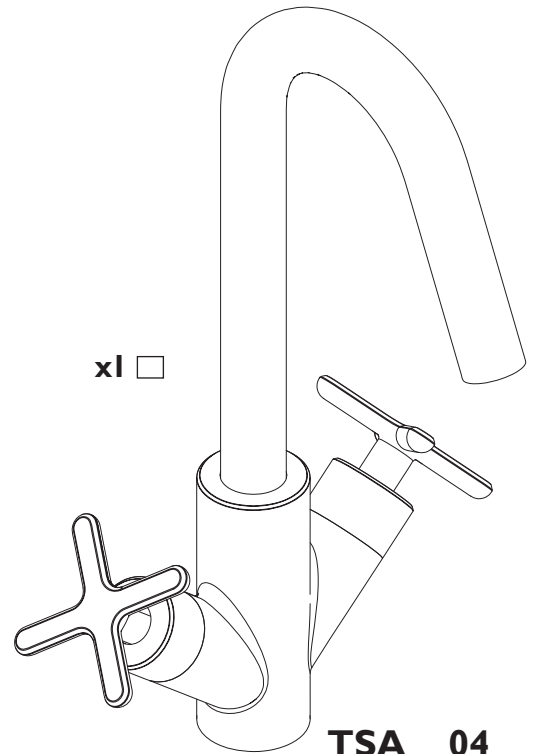

TSA__04

Tall Basin Mixer

300mm;
240mm
length
available
once
screwed in

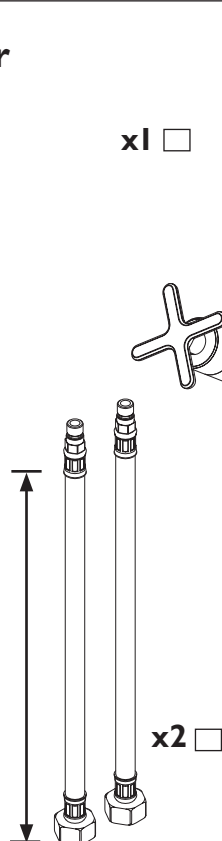

x1

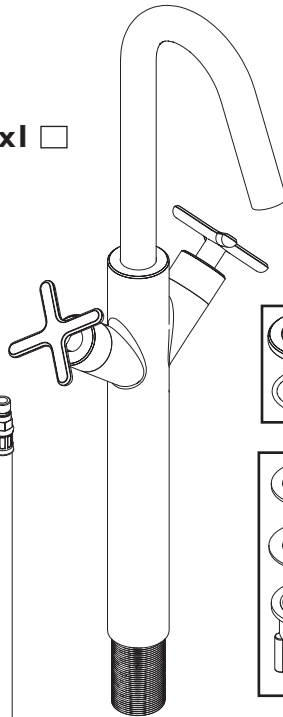

x1

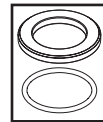

x1

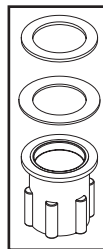

TSA__T04



TOOLS REQUIRED

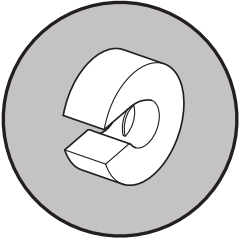

Pipe Cutter

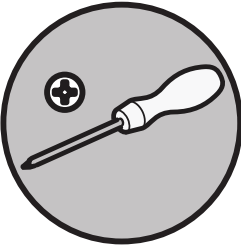

Cross Head Screwdriver



Adjustable Spanner

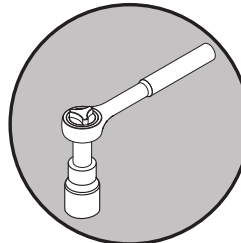

17mm Socket Spanner

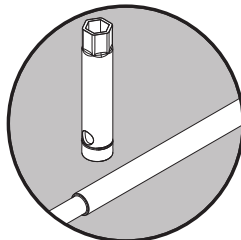

11mm Box Spanner

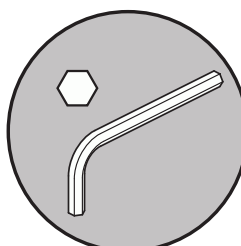

2mm Hexagonal Key



INSTALLATION - BASIN MIXER

1

Screw the flexible tails and fixing kit rod into the tap body. **DO NOT OVERTIGHTEN.**

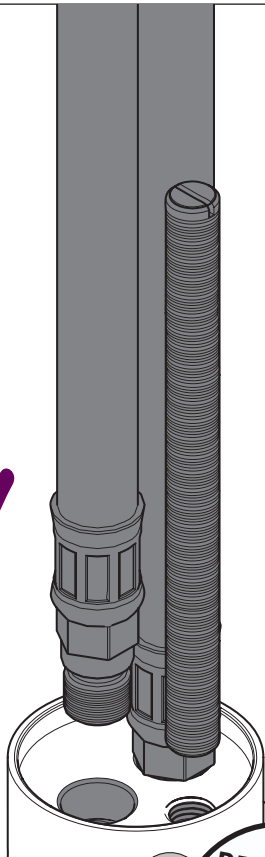

2

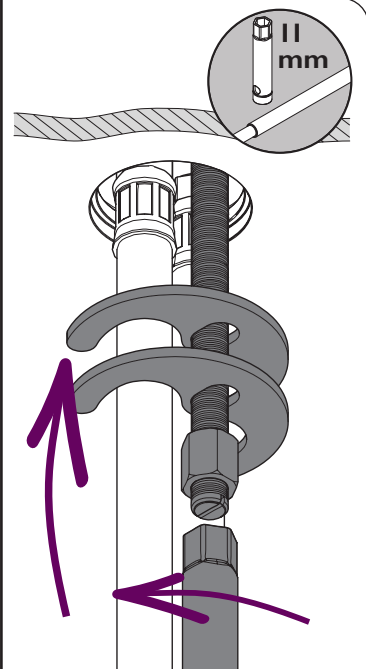
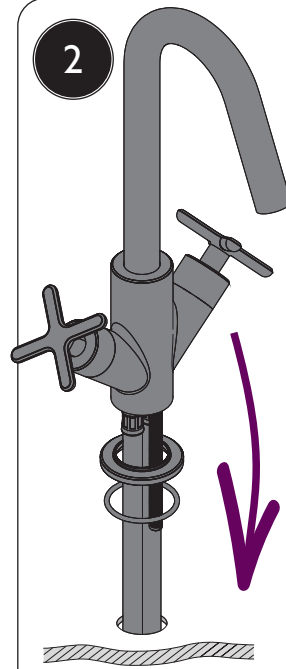

Feed the tap body through the hole in the basin, ensuring the plinth and washer is in place. Secure the basin mixer using the fixing kit.

3

Connect the hot and cold water supplies using suitable connectors (not supplied). Ensure that there are no kinks, twists or loops in the flexible tails when connecting to prevent water supply issues.

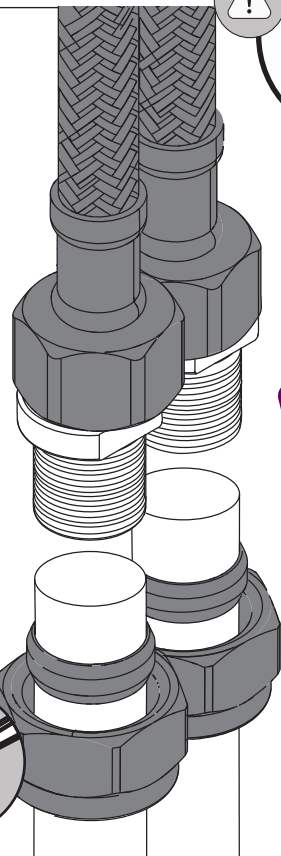
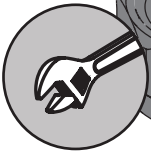
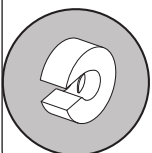

REMEMBER
Hot on the left, cold on the right!

4

Operation

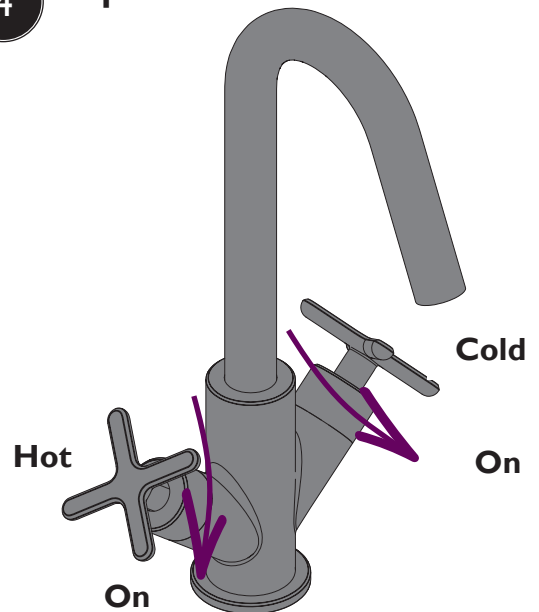

Turn on the water supply and check all joints and connections for leaks.



INSTALLATION - TALL BASIN MIXER

1

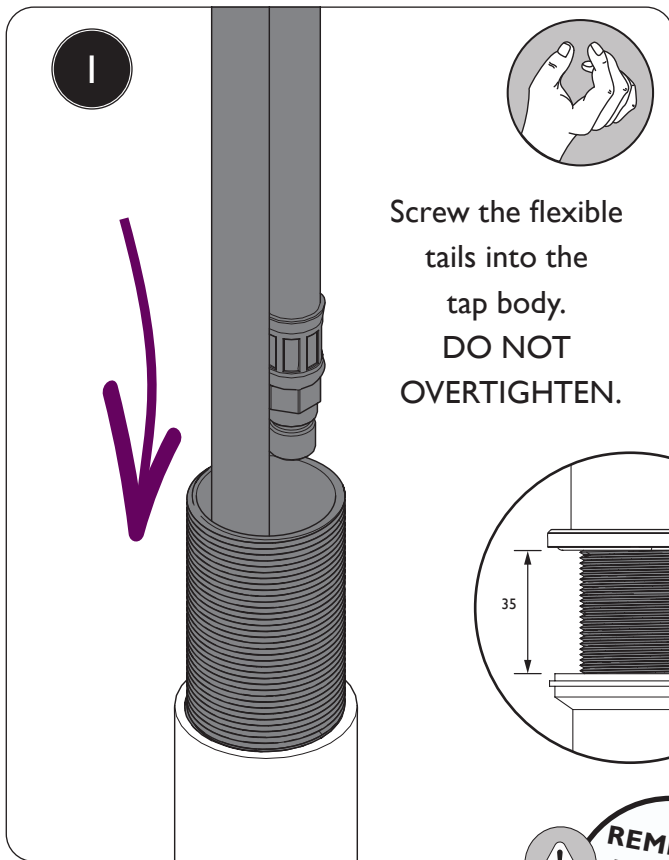

Screw the flexible tails into the tap body. **DO NOT OVERTIGHTEN.**

35

2

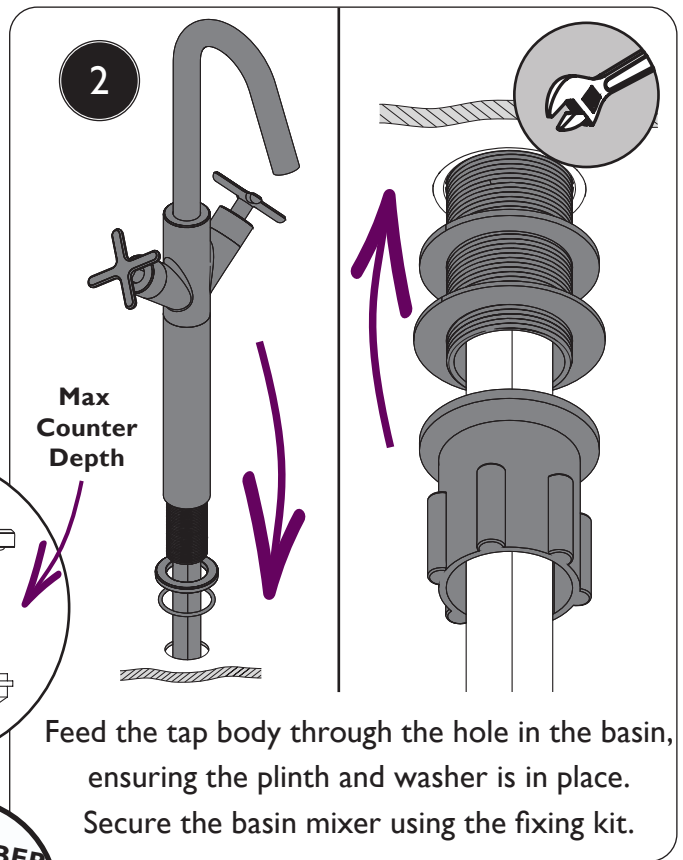

Max Counter Depth

Feed the tap body through the hole in the basin, ensuring the plinth and washer is in place. Secure the basin mixer using the fixing kit.

3

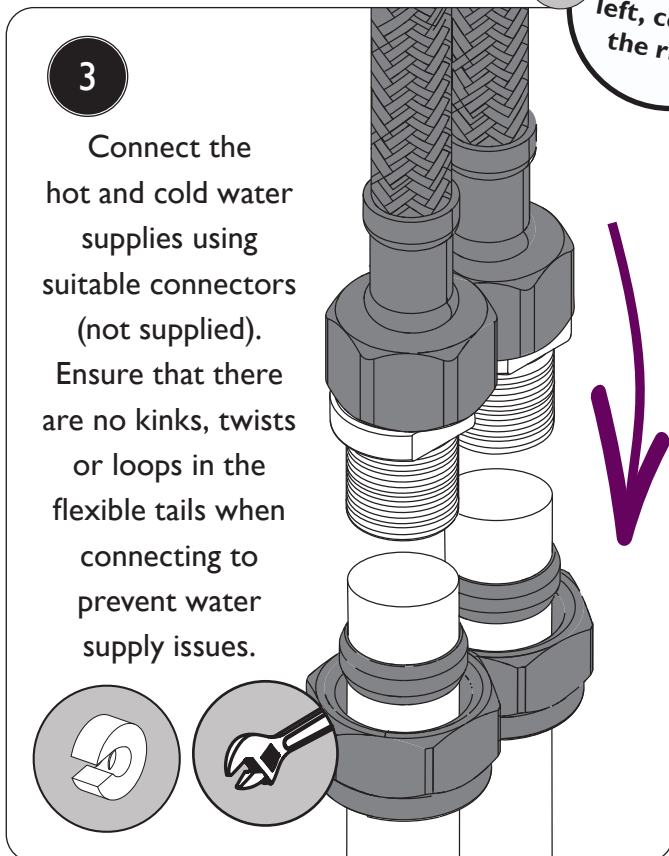

Connect the hot and cold water supplies using suitable connectors (not supplied). Ensure that there are no kinks, twists or loops in the flexible tails when connecting to prevent water supply issues.

REMEMBER
Hot on the left, cold on the right!

4 Operation

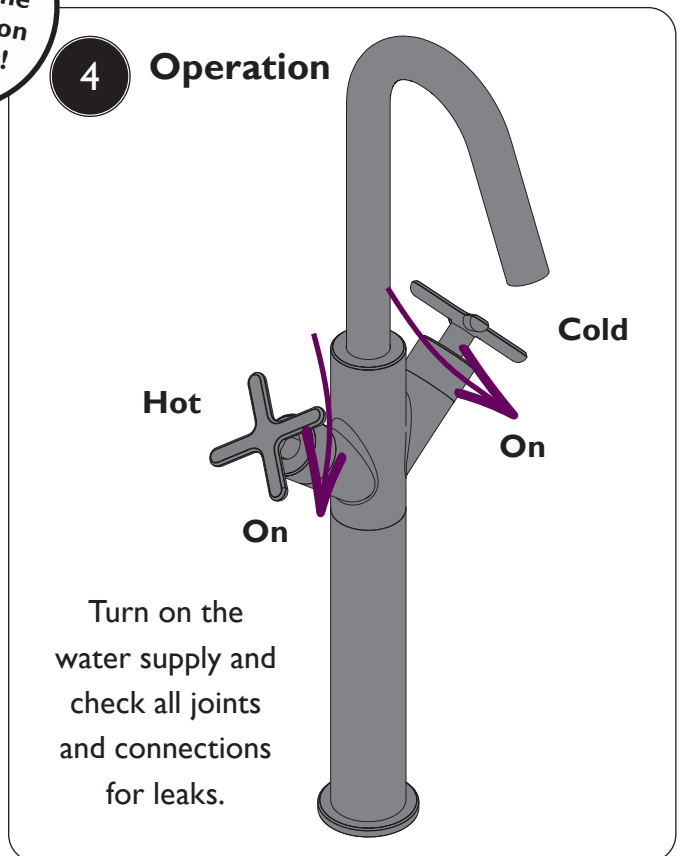

Hot On Cold On

Turn on the water supply and check all joints and connections for leaks.



MAINTENANCE

1 Remove/Replace Valves

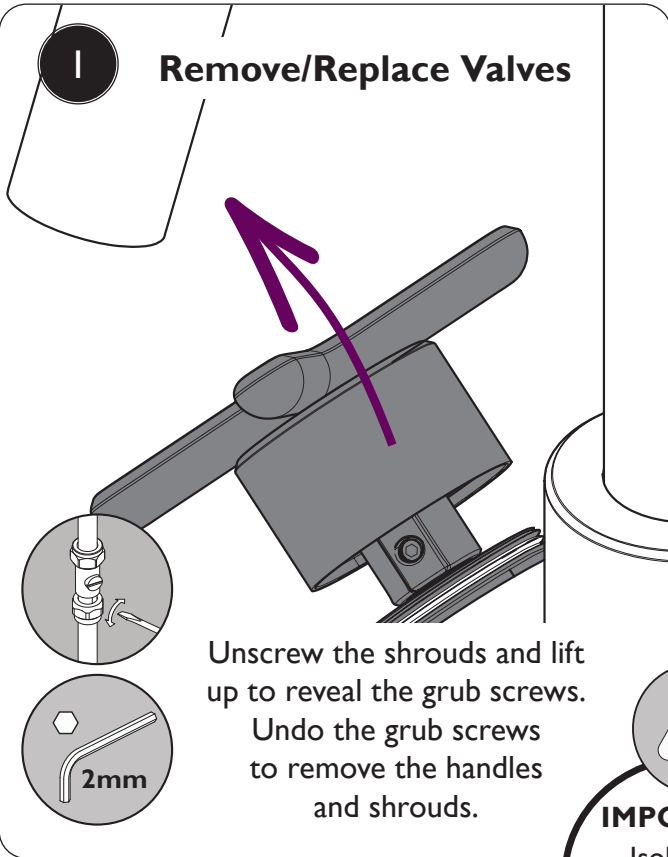

2

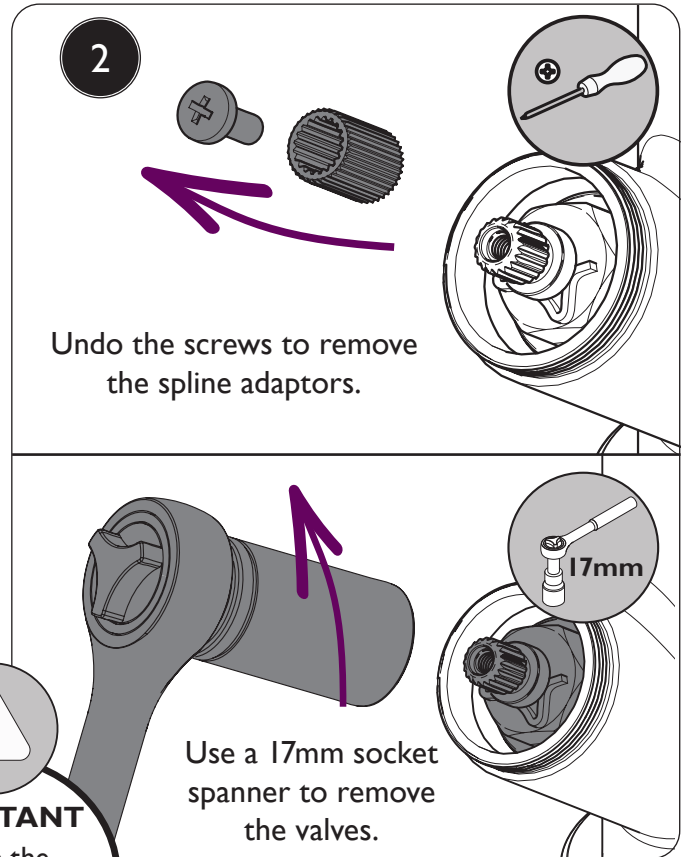

IMPORTANT
Isolate the water supply before starting!

3



Visit www.heritagebathrooms.com or scan the QR Code and search for your product code to replace valves if necessary.

4

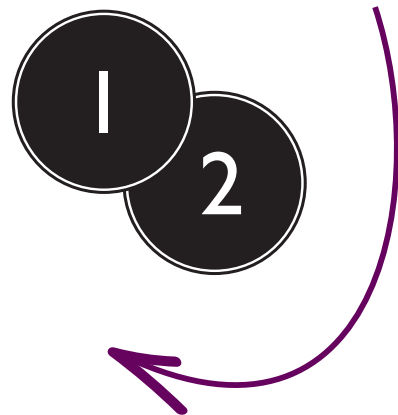

Reverse the steps to replace the valves and handles.



MAINTENANCE

1 Clean/Replace Outlet

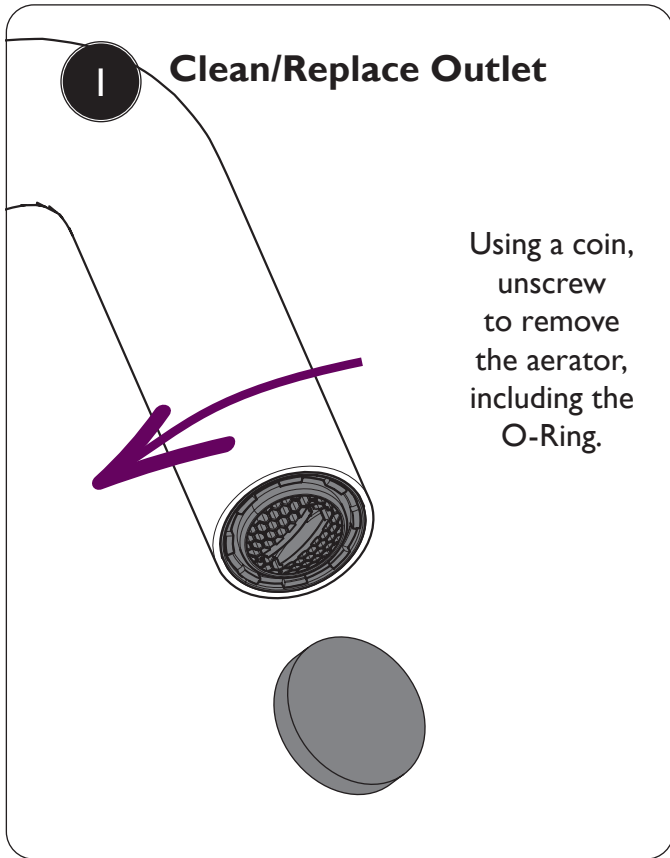

Using a coin, unscrew to remove the aerator, including the O-Ring.

2

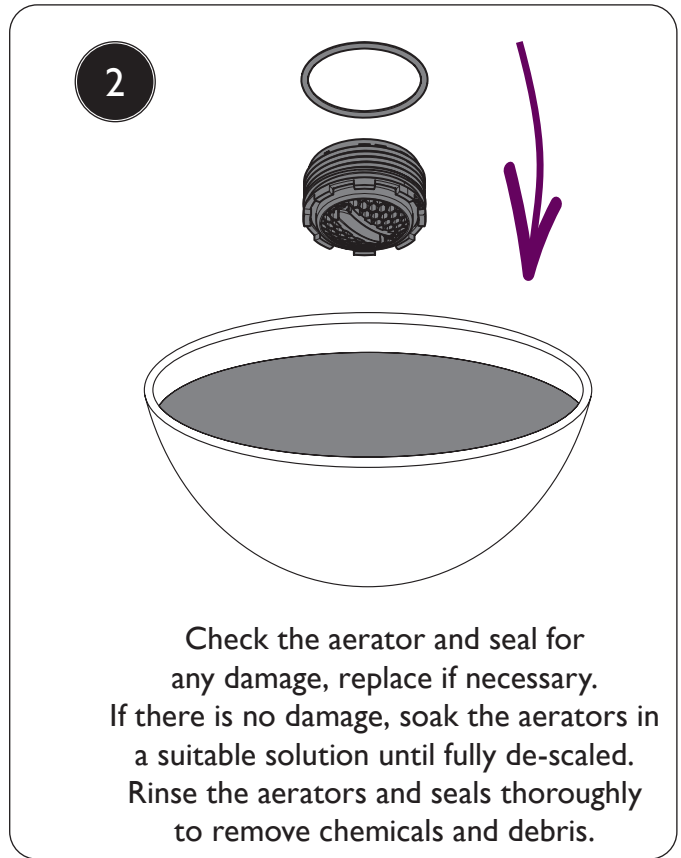

Check the aerator and seal for any damage, replace if necessary. If there is no damage, soak the aerators in a suitable solution until fully de-scaled. Rinse the aerators and seals thoroughly to remove chemicals and debris.

3

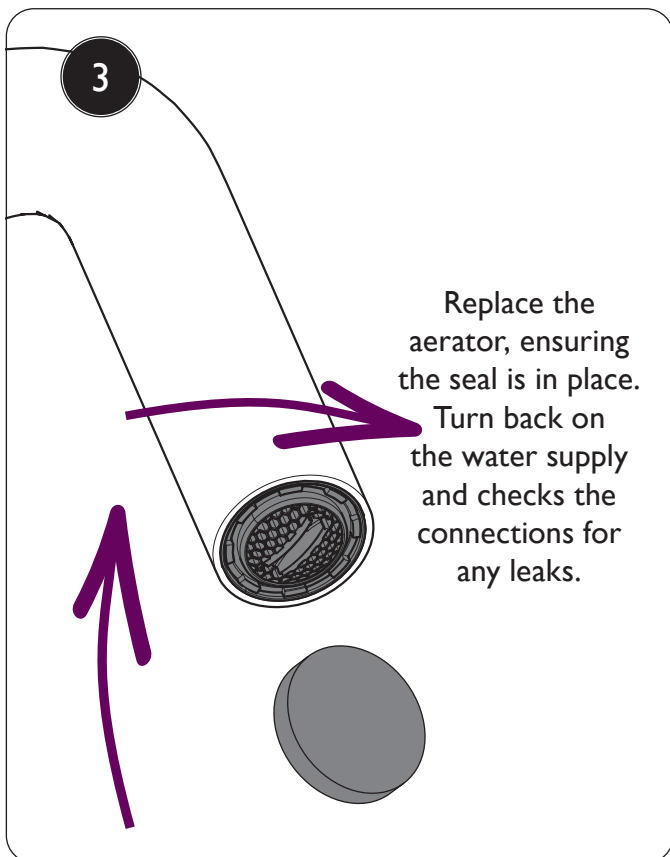

Replace the aerator, ensuring the seal is in place. Turn back on the water supply and check the connections for any leaks.



TROUBLESHOOTING

Symptom	Cause	Remedy
No flow or low flow rate	Partially closed isolation valve.	Open isolation valve.
	Instantaneous water heater cycles on and off as flow rate or pressure is too low.	Increase water flow rate or pressure through system.
	Head of water is below the minimum distance required.	Refer to specification for minimum distance required.
	Hot or cold water being drawn off elsewhere causing pressure changes or instantaneous boiler temperature changes.	Do not use other water outlets when using the taps.
	Airlock or partial blockage in the supply pipework.	Flush through pipework to ensure removal of debris and any airlocks.
Water dripping from taps	This is normal for a short time after using the taps.	This is caused by residual water tension, the build up of water in the tap body.
	If water continues to drip, possibly due to the ceramic disc valves	Remove valves and clean, refer to 'Maintenance' section before starting any maintenance.
Taps do not turn on	Closed isolation valve.	Open isolation valve.
	Mains water supply turned off.	Turn on mains water supply.



CARING FOR YOUR PRODUCT

Heritage products are made from premium materials, with hand polished, PVD, EPD or electroplated finishes.

Your product should be regularly cleaned with warm water, a mild pH-neutral liquid soap, and polished with a soft cloth. Any residues from soap, toiletries etc. should be rinsed off straight after use.

Household bleaches and cleaners contain harsh chemicals and may damage the surface finish. Avoid using abrasive cloths, scouring pads, scrub sponges, steel wool or anything similar.

Some surfaces such as nickel and pewter may be affected by the dye found in some cloths, so it is also important to avoid leaving cloths on surfaces.

GUARANTEE

The confidence we have in the quality of our products and services enables us to offer a free peace-of-mind product guarantee from 2 years up to a lifetime guarantee against any manufacturing faults, with proof of purchase. In addition, our attentive customer service team are available to help solve any problems which may arise quickly and effectively so you can enjoy your bathroom.

To see the specific guarantee for this product, scan the QR Code or visit the following URL:

<https://www.heritagebathrooms.com/service-centre/guarantee>

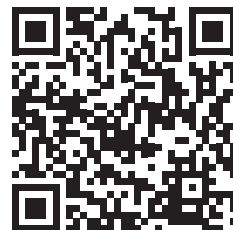

NEED HELP?

If your product does not function correctly when you first use it, contact your plumber and make sure that it has been installed and commissioned in line with this Installation and User Guide supplied with the product. If this doesn't solve the problem, then please visit <https://www.heritagebathrooms.com/service-centre/help-and-advice> for some helpful hints and tips; or contact Heritage Customer Service on 0330 026 8503 where our expert team of advisors will be able to offer you, or your plumber, help and advice.



HERITAGE[®]

BATHROOMS

We love to see how Heritage products are used so please keep in touch and share pictures of your new bathroom with us.



@heritagebathrooms

If you have any queries, our dedicated customer service teams and products experts are available to help.

Email us enquire@heritagebathrooms.com Call us **0330 026 8503** Website www.heritagebathrooms.com

UK: Heritage Bathrooms, Pooley Hall Drive, Birch Coppice Business Park, Dordon, Tamworth B78 1SG

EU: Masco Europe S.à.r.l., 14 Rue Strachen, 6933 Mensdorf, Luxembourg.