

HERITAGE

BATHROOMS

Installation Guide



Models Covered:

**Salcombe Bath Filler &
Bath Shower Mixer**

**TSACC02, TSACBB02,
TSACBL02, TSACC07,
TSACBB07, TSACBL07**

Please keep this booklet for future reference.

Installer: When you have read these instructions, please ensure you leave them with the user.

INTRODUCTION

Thank you for buying a Heritage Product. When you buy a Heritage product, you can be confident that it not only features a beautiful, distinctive, classic design, but that it has also been made to the very highest quality standards.

To ensure that it works to its full potential, it needs to be fitted correctly.

These fitting instructions have been created to give you all of the information you need and, if you need any further help, please do not hesitate to give us a call on: 0330 026 8503.

CONTENTS

SPECIFICATION	3
PACK CONTENTS	4
TOOLS REQUIRED	4
INSTALLATION - BATH SHOWER MIXER	5-6
INSTALLATION - BATH FILLER	7
MAINTENANCE	8-11
TROUBLESHOOTING	12
CARING FOR YOUR PRODUCT	13
GUARANTEE	13
NEED HELP?	13
NOTES	14-15



SAFETY NOTES

All products manufactured and supplied by Heritage are safe to use provided that they are installed, operated and receive regular maintenance in accordance with these instructions.

This product needs to be installed in accordance with, and meet the requirements of the Water Supply (Water Fittings) Regulations 1999 and current by-laws.

Isolation valves must be fitted to the inlet water supplies to ensure ease of future maintenance.

Before installing this product the water supply must be thoroughly flushed in order to remove any swarf, solder etc. Full access must be made available for future maintenance/ servicing purposes.

If power tools are used do not forget to:

- Wear eye protection
- Unplug equipment after use

This product must not be modified in any way as this will invalidate the guarantee.

If in doubt, contact a registered plumber, your Local Water Authority or the Secretary of the Institute of Plumbing, address as follows:-

The Institute of Plumbing,
64 Station Lane,
Hornchurch,
Essex,
RM12 6NB, Tel: 01708 472791

SPECIFICATION

OPERATING PRESSURE RANGE (BAR): TSA__02 - Min 0.5 bar, Max 5.0 bar
TSA__07 - Min 0.2 bar, Max 5.0 bar

MAXIMUM STATIC PRESSURE (BAR): 10 bar

INLET WATER TEMPERATURE RANGE: Hot - Max 65°C

INLET CONNECTIONS: 3/4" BSP

HOSE CONNECTION: G1/2" (TSA__02 only)



PACK CONTENTS

Bath Shower Mixer

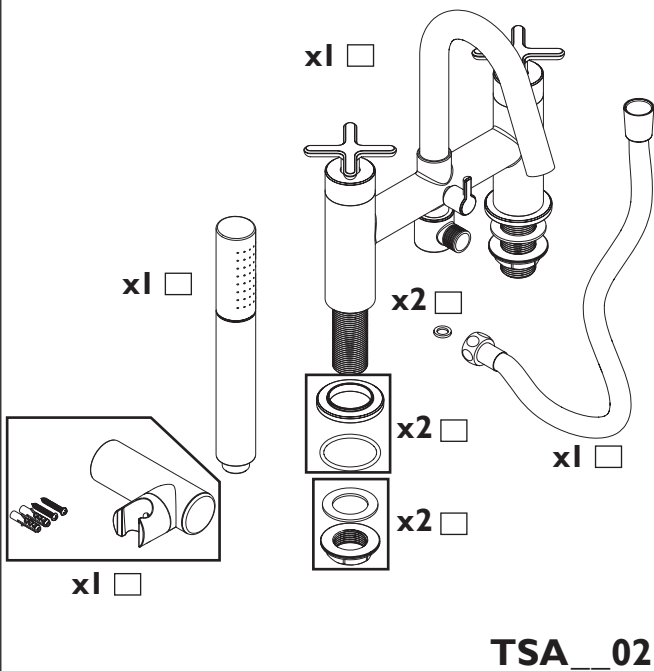

Bath Filler

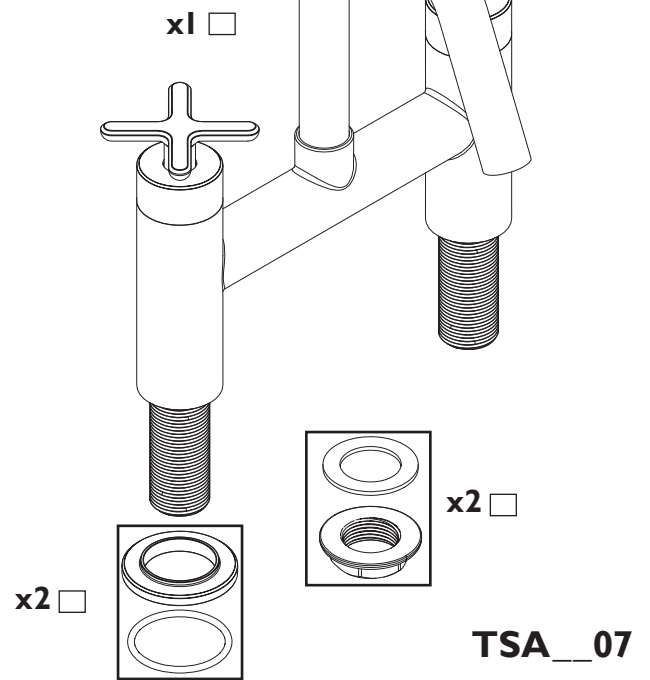

TOOLS REQUIRED

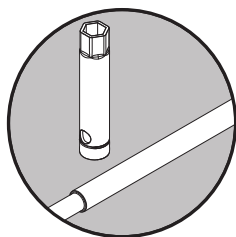

**32mm
Box Spanner**

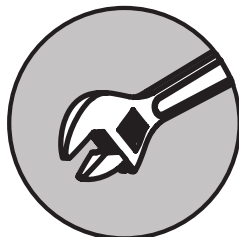

**Adjustable
Spanner**

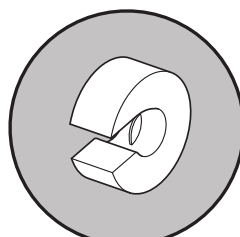

Pipe Cutter

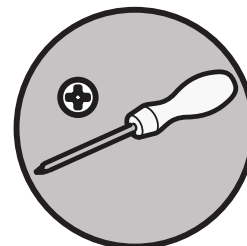

**Cross Head
Screwdriver**

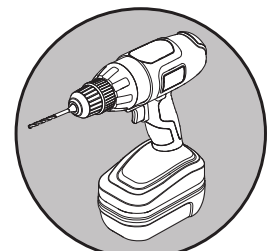

Drill

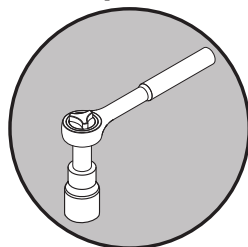

**17mm Socket
Spanner**

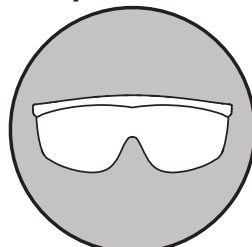

Safety Goggles

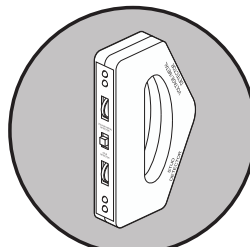

**Electronic
Detector**

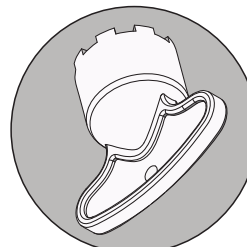

**16mm Outlet Key
(not supplied)**

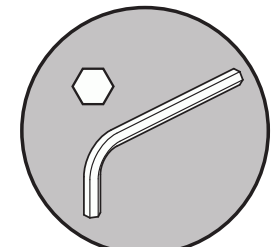

**2mm & 8mm
Hexagonal Keys**



INSTALLATION - BATH SHOWER MIXER

1

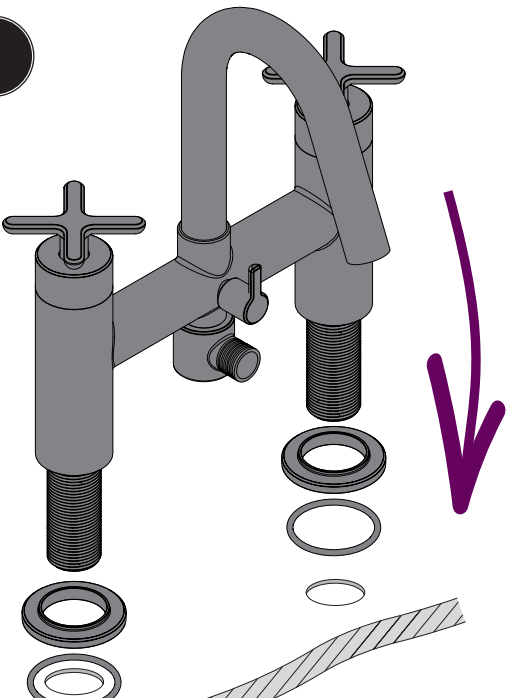

Fit the tap to the bath, ensuring the plinths are in place.

2

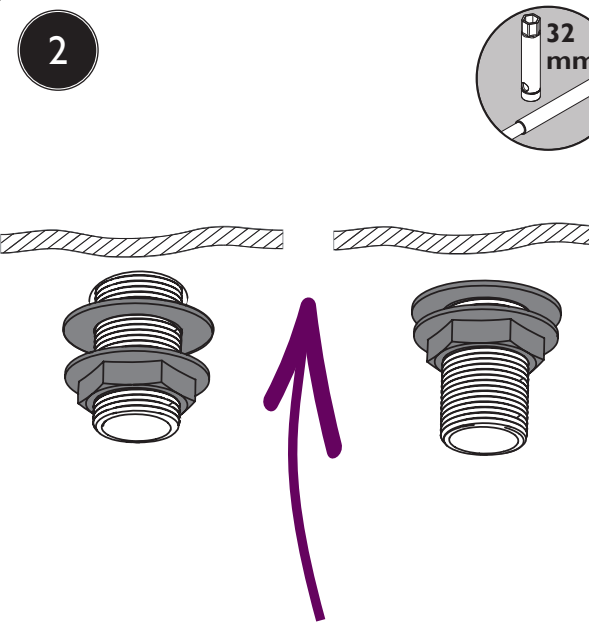

Secure the tap to the bath by using the washers and metal backnuts below the bath.

3

Hot Cold

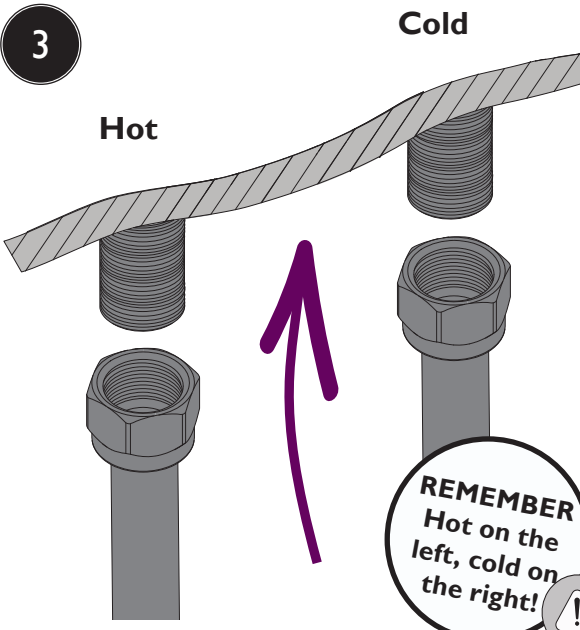

Connect the hot and cold water supplies to the threaded tails.

REMEMBER
Hot on the left, cold on the right!

4

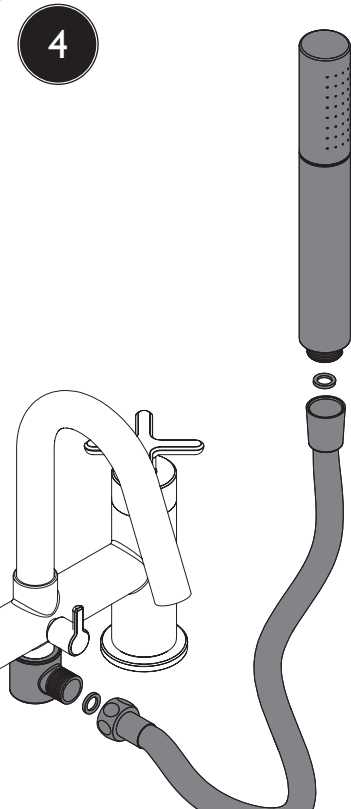

Connect the hose to the bath shower mixer and handset, ensuring the washers are in place.



INSTALLATION - BATH SHOWER MIXER

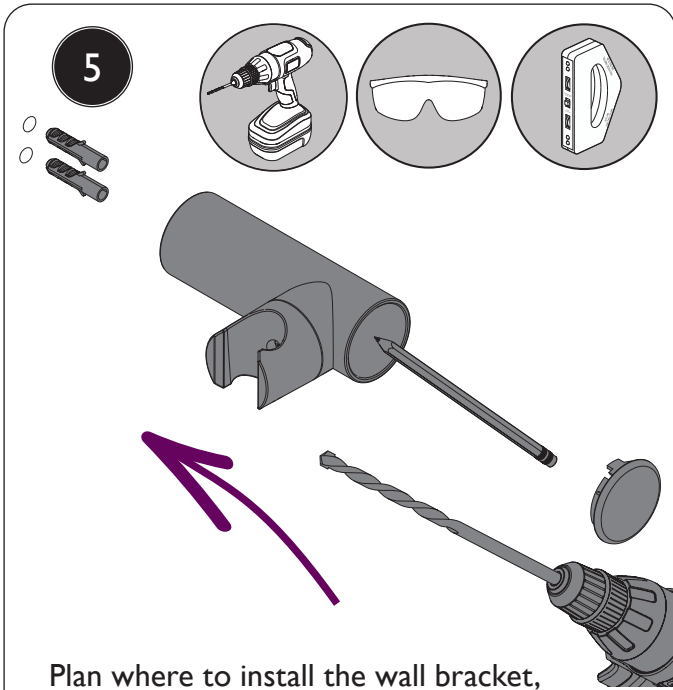

5 Plan where to install the wall bracket, making sure the hose and handset can easily reach. Remove the cap, mark the position of the fixing holes and drill using a 6mm drill bit..

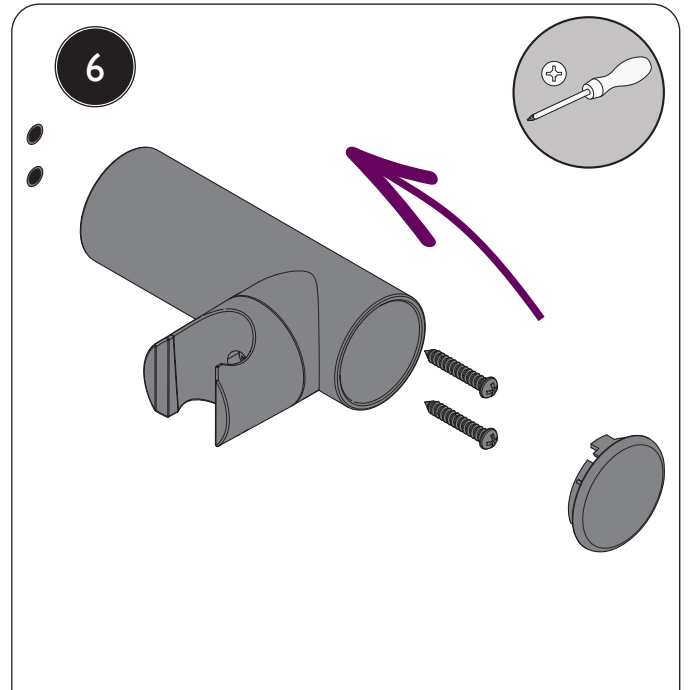

6 Screw the wall bracket to the wall. Use wall plugs where necessary depending on the wall type. Push on the cap.

IMPORTANT
Prior to drilling into walls check there are no hidden electrical wires, cables or water supply pipes.

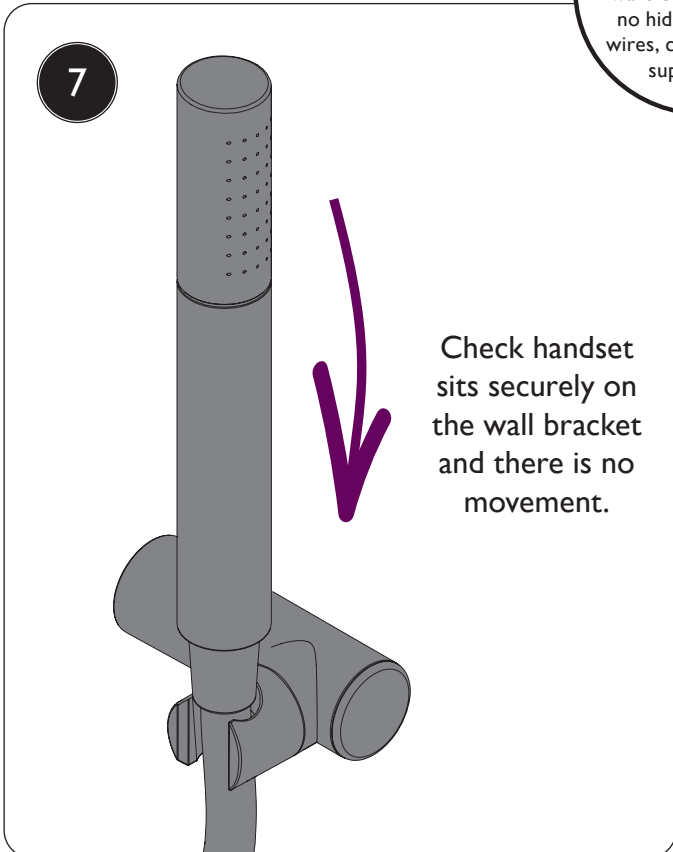

7 Check handset sits securely on the wall bracket and there is no movement.

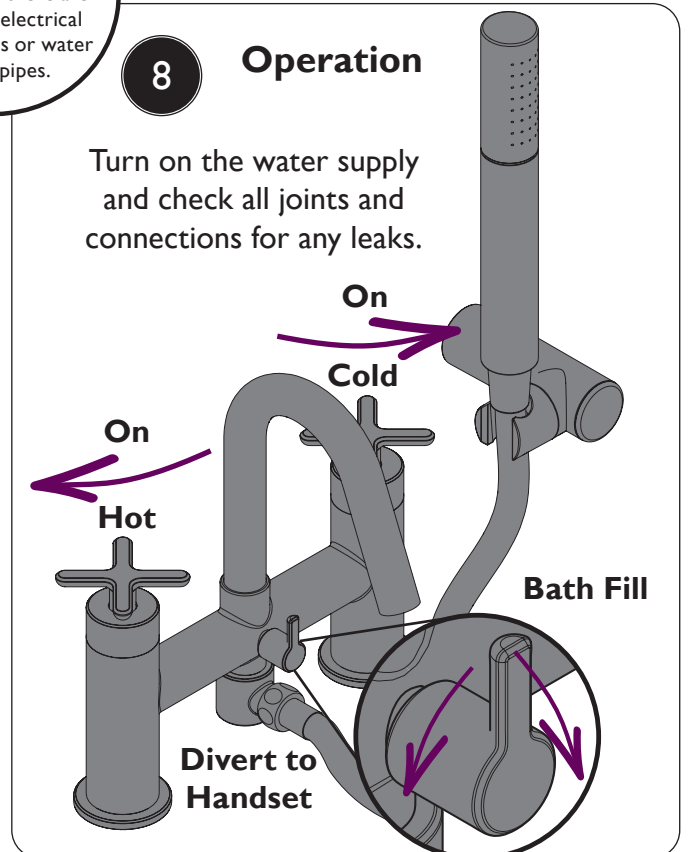

8 **Operation**
Turn on the water supply and check all joints and connections for any leaks.

INSTALLATION - BATH FILLER

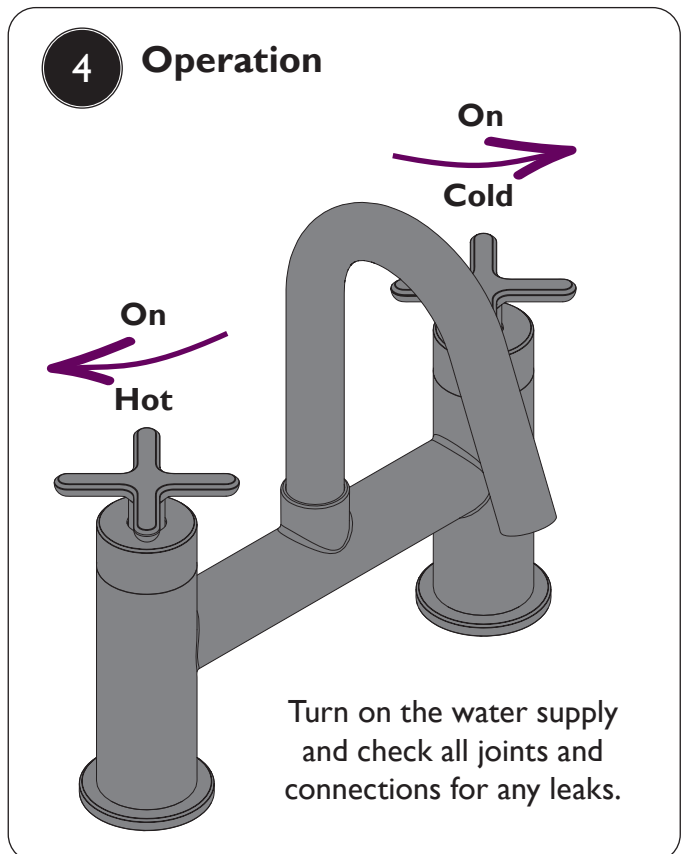
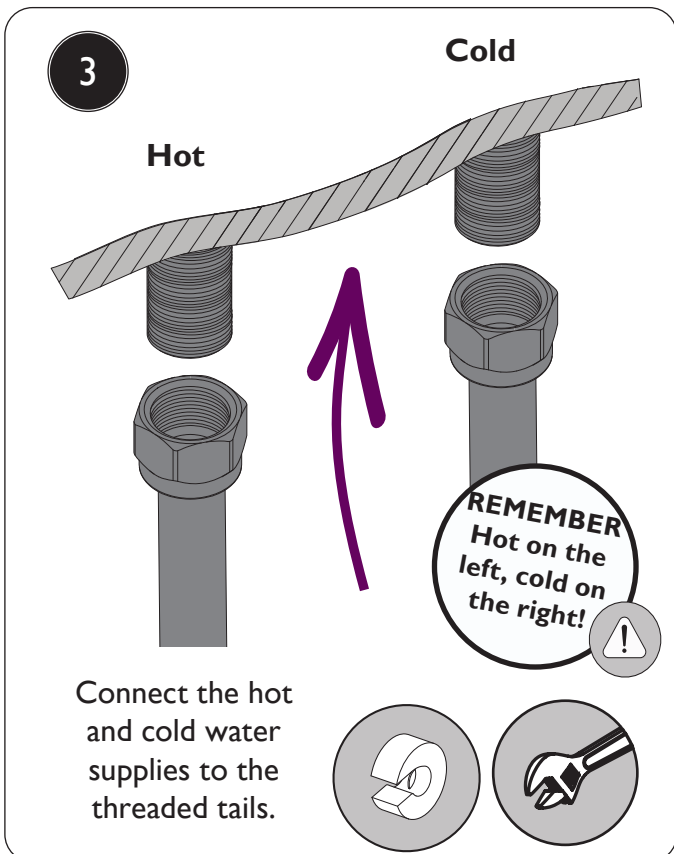
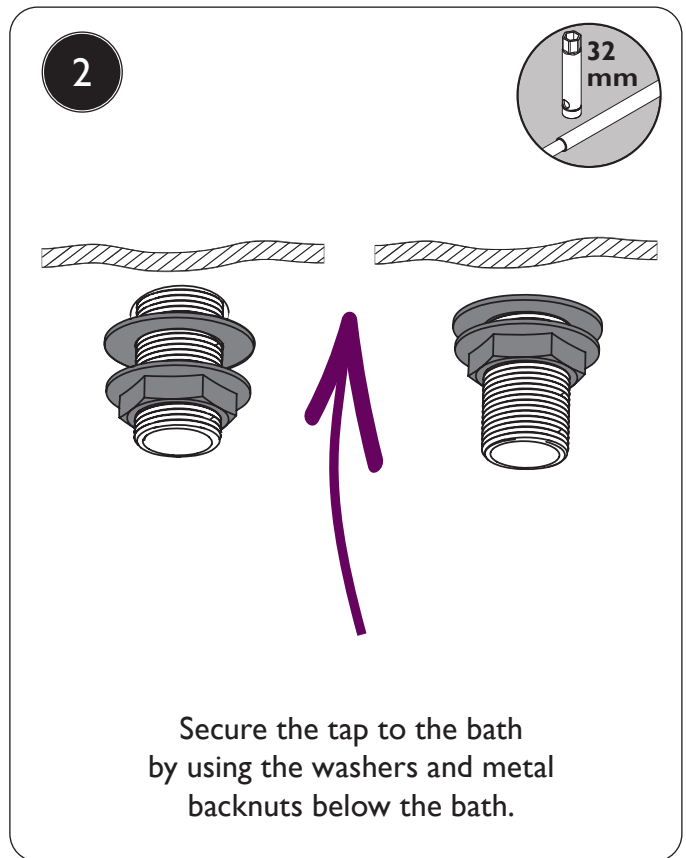
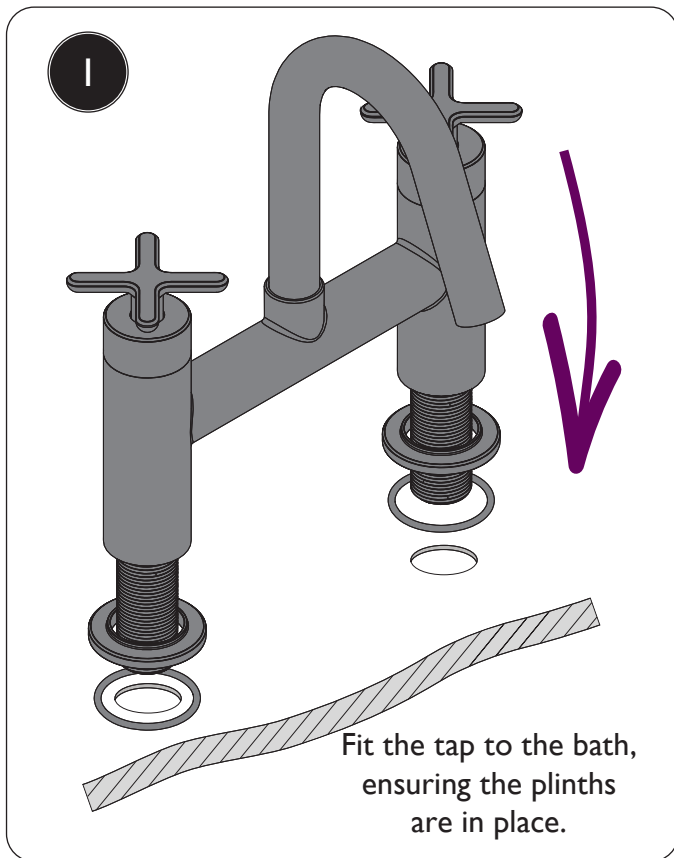

MAINTENANCE

1 Remove/Replace Valves

Unscrew the shrouds and lift up to reveal the grub screws.

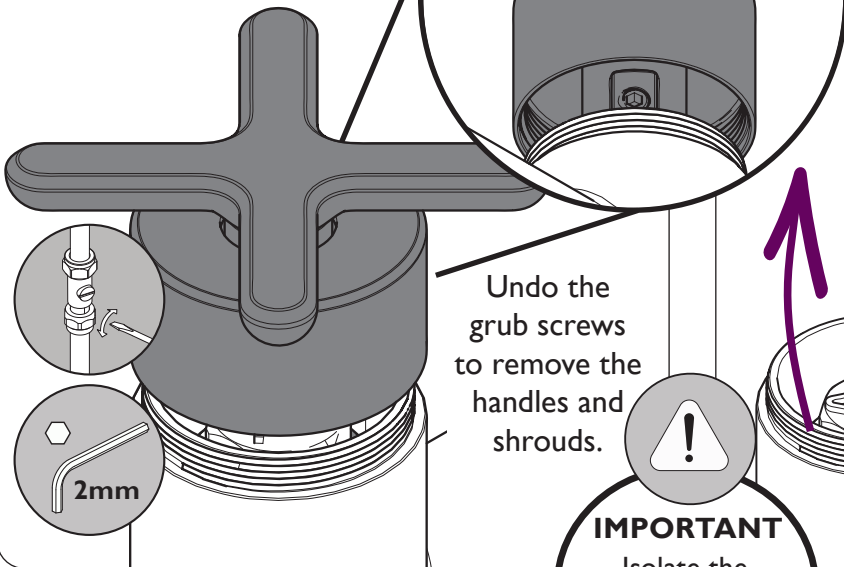

2

Undo the screws to remove the spline adaptors. Use a 17mm socket spanner to remove the valves.

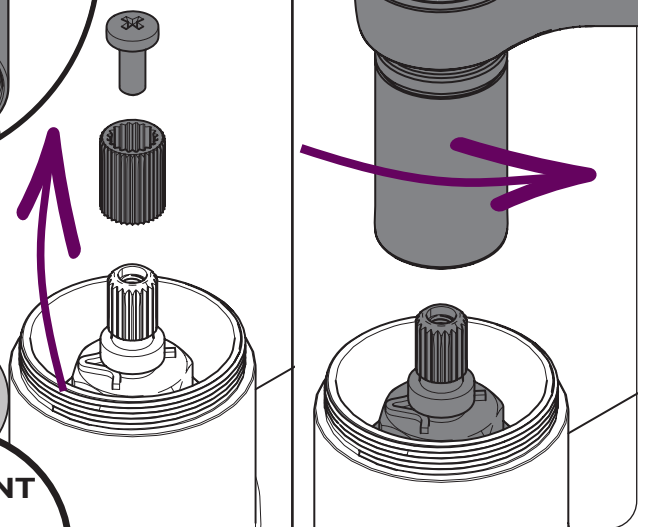

IMPORTANT
Isolate the water supply before starting!

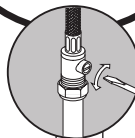

3



Visit www.heritagebathrooms.com or scan the QR Code and search for your product code to replace valves if necessary.

4

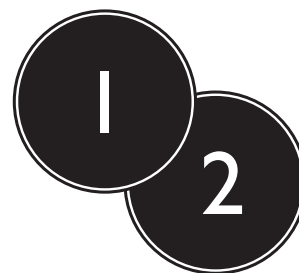

Reverse the steps to replace the valves and handles.



MAINTENANCE

1

Clean/Replace Outlet

Using a 16mm outlet key (not supplied), unscrew the aerator and remove, including the O-Ring.

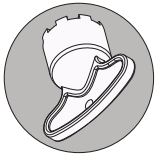
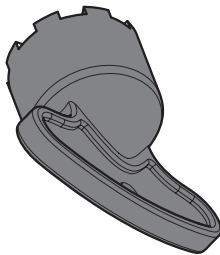

Visit our website to purchase your outlet key if required.



2

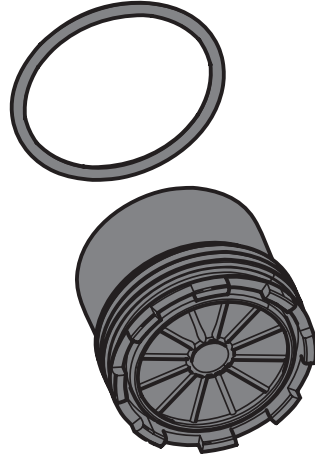

Check the outlet and seal for any damage, replace if necessary.

3

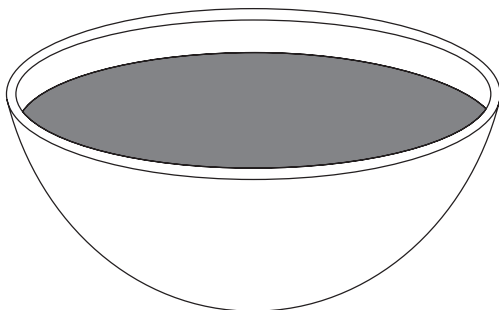
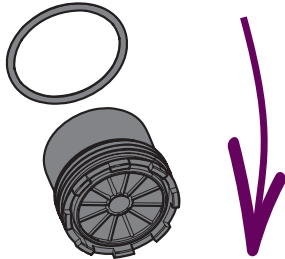

If there is no damage, soak the aerator in a suitable solution until fully de-scaled. Rinse the aerator and seal thoroughly to remove chemicals and debris.

4

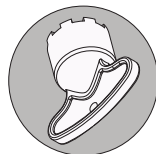
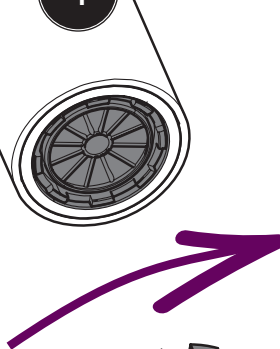

Replace the aerator, ensuring the seal is in place.

Turn back on the water supply and check the connections for any leaks.



MAINTENANCE

1 Clean/Replace Diverter

At the back of the tap, use a coin to undo the diverter cap; and a hex key to undo the spout screw.

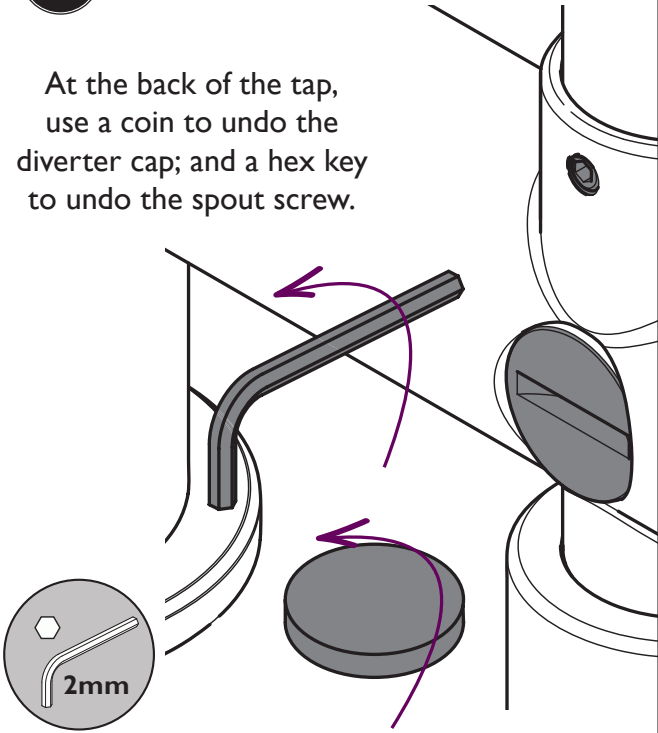

2

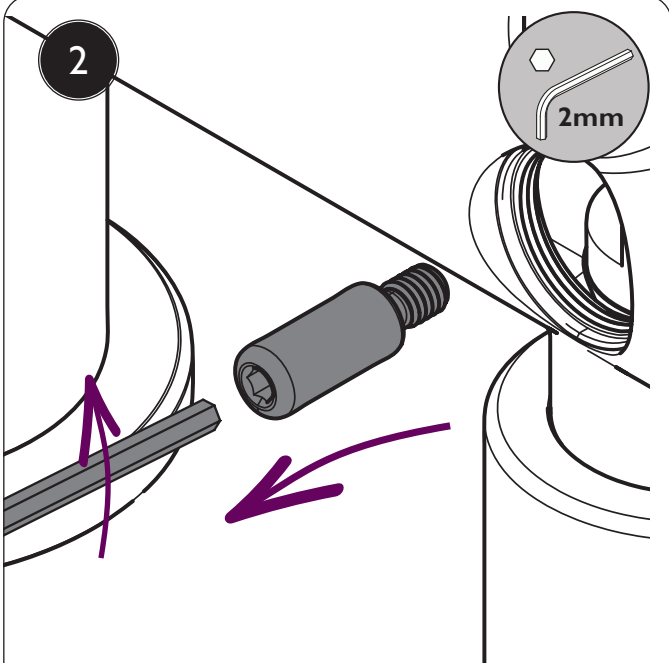

Remove the diverter peg using a 2mm hex key.

3

Remove the spout.

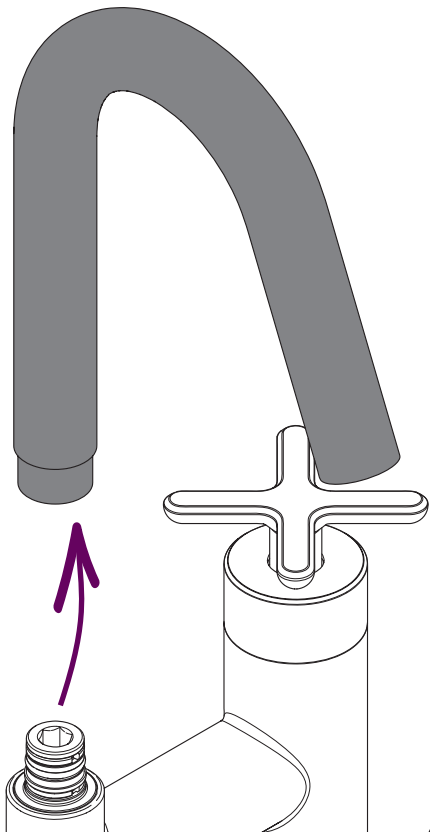

4

Unscrew the spout connector and pull out the diverter from the top.

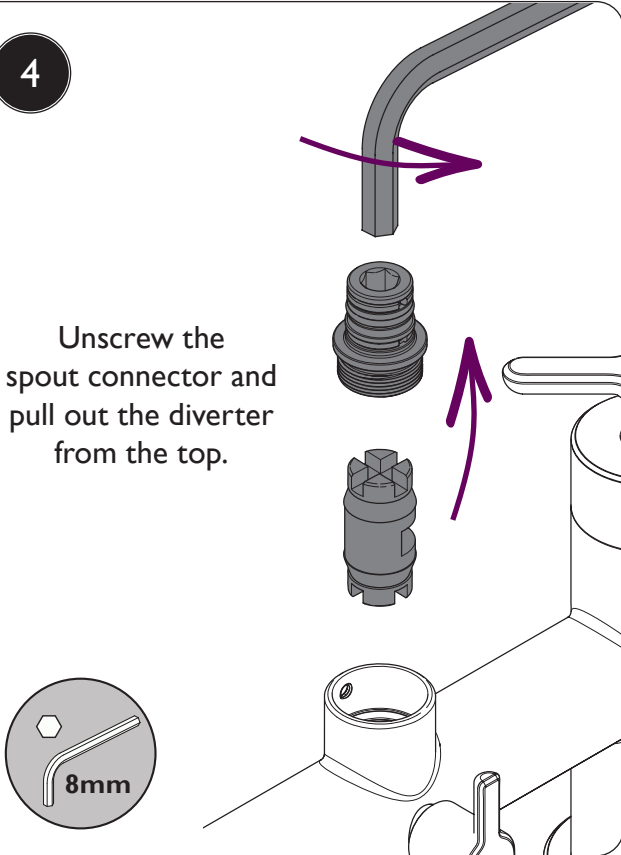

MAINTENANCE

5

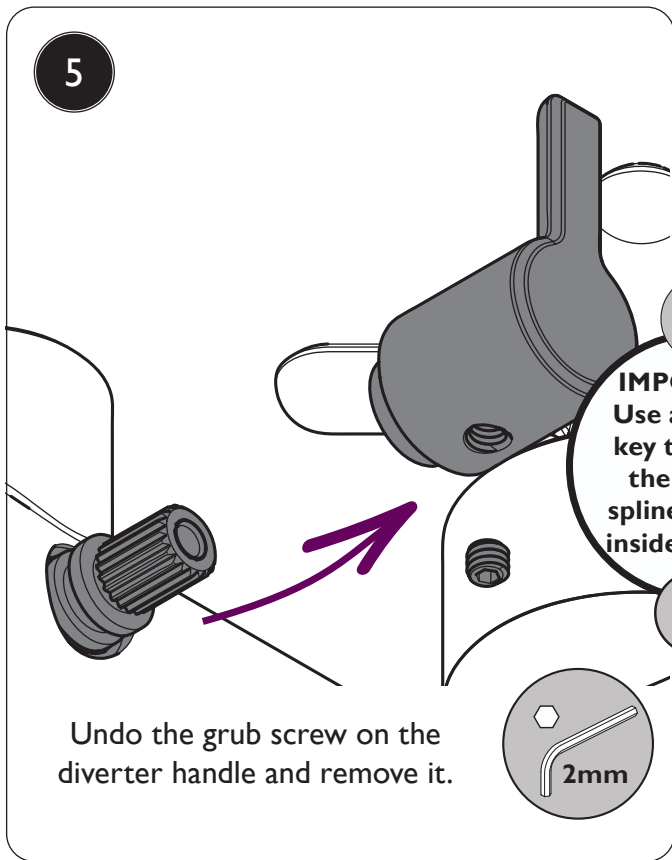

Undo the grub screw on the diverter handle and remove it.

2mm

This diagram shows a diverter handle with a grub screw being removed. A 2mm hex key is shown as the tool used for this step.

6

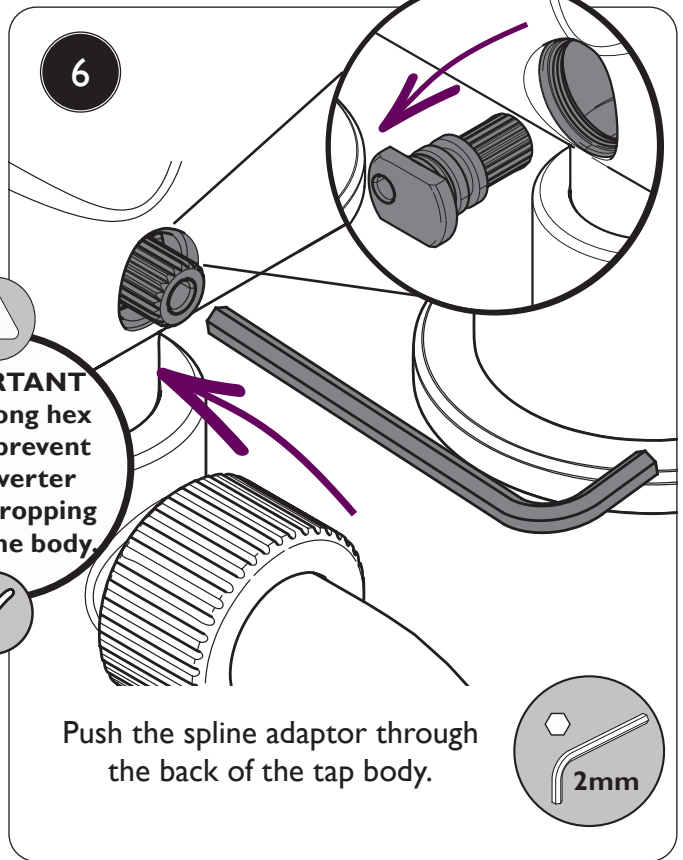

Push the spline adaptor through the back of the tap body.

2mm

IMPORTANT
Use a long hex key to prevent the diverter spline dropping inside the body.

This diagram shows a spline adaptor being inserted into the back of the tap body. A 2mm hex key is used to hold the diverter spline in place. A callout shows a close-up of the spline being held by the hex key. A warning icon and a checkmark icon are also present.

7

Soak the diverter components in a suitable solution until fully de-scaled. Rinse thoroughly to remove any chemicals and debris.

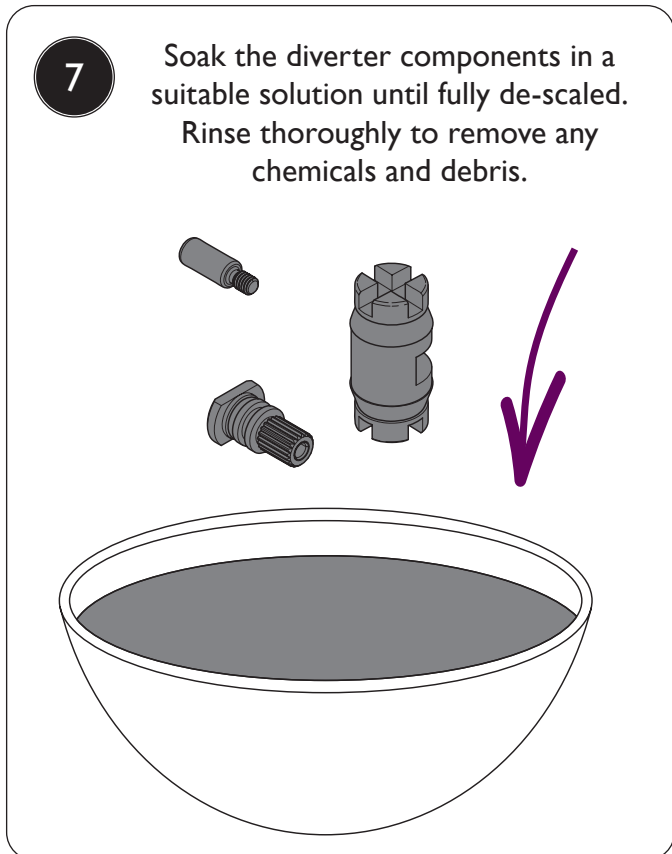

This diagram shows three diverter components being placed into a bowl of liquid. A large arrow points from the components towards the bowl.

8

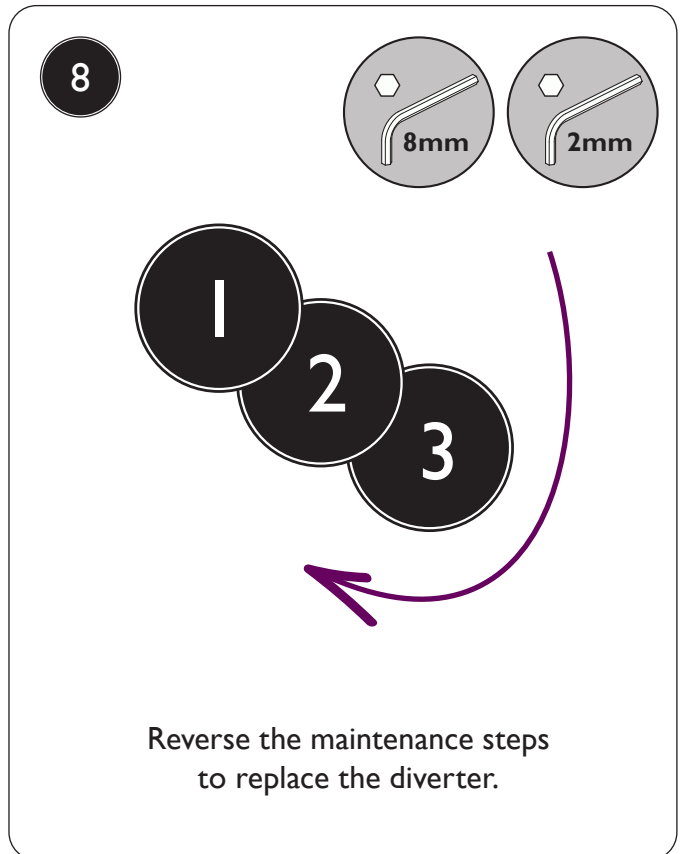

Reverse the maintenance steps to replace the diverter.

8mm 2mm

1 2 3

This diagram shows three numbered circles (1, 2, 3) with arrows indicating a reverse sequence. Two hex keys are shown at the top: an 8mm hex key and a 2mm hex key.

TROUBLESHOOTING

Symptom	Cause	Remedy
No flow or low flow rate	Partially closed isolation valve.	Open isolation valve.
	Instantaneous water heater cycles on and off as flow rate or pressure is too low.	Increase water flow rate or pressure through system.
	Head of water is below the minimum distance required.	Refer to specification for minimum distance required.
	Hot or cold water being drawn off elsewhere causing pressure changes or instantaneous boiler temperature changes.	Do not use other water outlets when using the taps.
	Airlock or partial blockage in the supply pipework.	Flush through pipework to ensure removal of debris and any airlocks.
Water dripping from taps	This is normal for a short time after using the taps.	This is caused by residual water tension, the build up of water in the tap body.
	If water continues to drip, possibly due to the ceramic disc valves	Remove valves and clean, refer to 'Maintenance' section before starting any maintenance.
Taps do not turn on	Closed isolation valve.	Open isolation valve.
	Mains water supply turned off.	Turn on mains water supply.



CARING FOR YOUR PRODUCT

Heritage products are made from premium materials, with hand polished, PVD, EPD or electroplated finishes.

Your product should be regularly cleaned with warm water, a mild pH-neutral liquid soap, and polished with a soft cloth. Any residues from soap, toiletries etc. should be rinsed off straight after use.

Household bleaches and cleaners contain harsh chemicals and may damage the surface finish. Avoid using abrasive cloths, scouring pads, scrub sponges, steel wool or anything similar. Some surfaces such as nickel and pewter may be affected by the dye found in some cloths, so it is also important to avoid leaving cloths on surfaces.

Your handset comes with rub clean nozzles, simply rub your fingers over the nozzles to clear any any build-up or debris.

GUARANTEE

The confidence we have in the quality of our products and services enables us to offer a free peace-of-mind product guarantee from 2 years up to a lifetime guarantee against any manufacturing faults, with proof of purchase. In addition, our attentive customer service team are available to help solve any problems which may arise quickly and effectively so you can enjoy your bathroom.

To see the specific guarantee for this product, scan the QR Code or visit the following URL:

<https://www.heritagebathrooms.com/service-centre/guarantee>

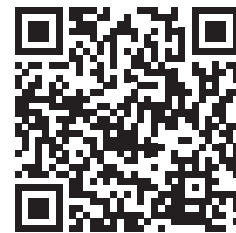

NEED HELP?

If your product does not function correctly when you first use it, contact your plumber and make sure that it has been installed and commissioned in line with this Installation and User Guide supplied with the product. If this doesn't solve the problem, then please visit <https://www.heritagebathrooms.com/service-centre/help-and-advice> for some helpful hints and tips; or contact Heritage Customer Service on 0330 026 8503 where our expert team of advisors will be able to offer you, or your plumber, help and advice.



NOTES



NOTES



HERITAGE[®]

BATHROOMS

We love to see how Heritage products are used so please keep in touch and share pictures of your new bathroom with us.



@heritagebathrooms

If you have any queries, our dedicated customer service teams and products experts are available to help.

Email us enquire@heritagebathrooms.com Call us **0330 026 8503** Website www.heritagebathrooms.com

UK: Heritage Bathrooms, Pooley Hall Drive, Birch Coppice Business Park, Dordon, Tamworth B78 1SG

EU: Masco Europe S.à.r.l., 14 Rue Strachen, 6933 Mensdorf, Luxembourg.