

	P-IX	DVGW	SVGW	ACS	WRAS	NF	KIWA
26638400				X			X
26670400				X			
26637400				X			X
26671400				X			
26636400				X			X
26672400				X			

hansgrohe

Hansgrohe · Auestraße 5 · 9 · D-77761 Schiltach
 Telefon +49 (0) 78 36/51-1282 · Telefax +49 (0) 7836/511440
 E-Mail: info@hansgrohe.com · Internet: www.hansgrohe.com

10/2018
9.02739.07

hansgrohe

- DE** Montageanleitung
- FR** Instructions de montage
- EN** assembly instructions
- IT** Istruzioni per Installazione
- ES** Instrucciones de montaje
- NL** Handleiding
- DK** Monteringsvejledning
- PT** Manual de Instalação
- PL** Instrukcja montażu
- CS** Montážní návod
- SK** Montážny návod
- ZH** 组装说明
- RU** Инструкция по монтажу
- HU** Szerelési útmutató
- FI** Asennusohje
- SV** Monteringsanvisning
- LT** Montavimo instrukcijos
- HR** Uputstva za instalaciju
- TR** Montaj kılavuzu
- RO** Instrucțiuni de montare
- EL** Οδηγία συναρμολόγησης
- SI** Navodila za montažo
- ET** Paigaldusjuhend
- LV** Montāžas instrukcija
- SR** Uputstvo za montažu
- NO** Montasjeveiledning
- BG** Инструкция за употреба
- SQ** Udhëzime rreth montimit
- AR** تعليمات التجميع

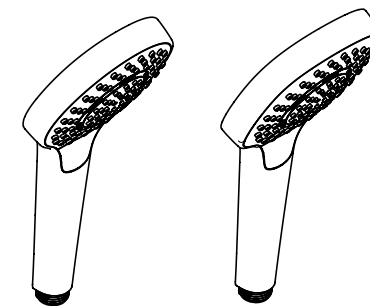

MySelect S Multi 26636400 / 26678402
MySelect S Vario 26637400 / 26679402
MySelect S 1jet 26638400
MySelect E Multi 26670400 / 26676402
MySelect E Vario 26671400 / 26677402
MySelect E 1jet 26672400

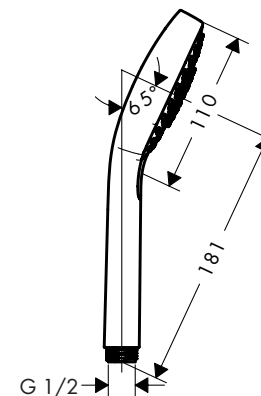

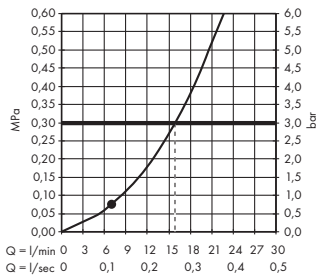
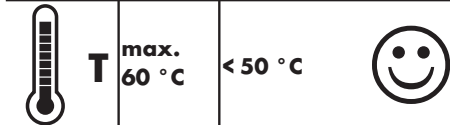

MySelect P 1jet 26638400

MySelect E 1jet 26672400

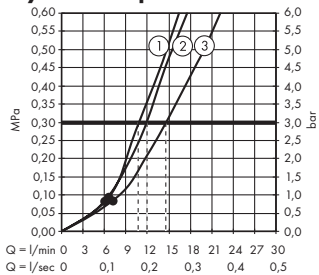

MySelect S Vario

26637400400 / 26679402

MySelect E Vario

26671400 / 26677402



2

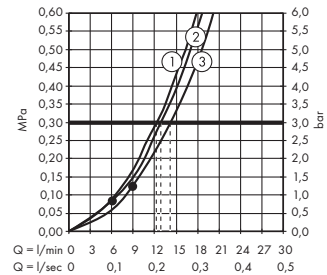
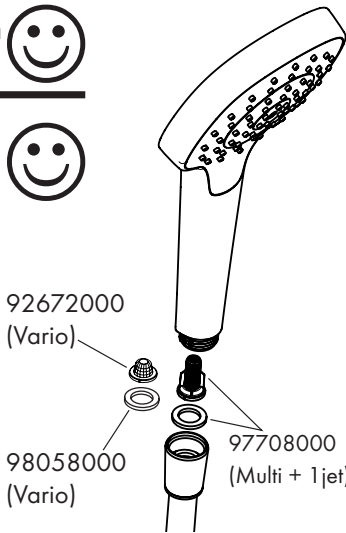

MySelect S Multi

26636400 / 26678402

MySelect E Multi

26670400 / 26676402



3

- DE** Reinigungsempfehlung / Garantie / Kontakt
- FR** Recommandation pour le nettoyage / Garanties / Contact
- EN** Cleaning recommendation / Warranty / Contact
- IT** Raccomandazione di pulizia / Garanzia / Contatto
- ES** Recomendaciones para la limpieza / Garantía / Contacto
- NL** Aanbevelingen inzake reiniging / Garantie / Contact
- DK** Rensning, anbefaling / Garanti / Kontakt
- PT** Recomendações de limpeza / Garantia / Contacto
- PL** Zalecenie dotyczące pielęgnacji / Gwarancja / Kontakt
- CS** Doporučení k čištění / Záruka / Kontakt
- SK** Odporúčania pre čistenie / Záruka / Kontakt
- ZH** 清洁指南 / 担保 / 接触
- RU** Рекомендации по очистке / Гарантия / Контакты
- HU** Tisztítási tanácsok / Garancia / érintkezés
- FI** Puhdistussuositus / Takuu / Kosketus
- SV** Rengöringsrekommendationer / Garanti / Contacto
- LT** Valymo rekomendacijos / Garantija / Kontaktai
- HR** Preporuke za čišćenje / Garancija / Kontakt
- TR** Temizleme önerisi / Garanti / Temas
- RO** Recomandări pentru curățare / Garanție / Contact
- EL** Σύσταση καθαρισμού / Εγγύηση / επαφή
- SL** Priporočilo za čiščenje / Garancija / Kontakt
- ET** Puhastussuovitused / Garantii / Kontakt
- LV** Tīrīšanas ieteikumi / Garantija / Kontakti
- SR** Preporuke za čišćenje / Garancija / Kontakt
- NO** Anbefaling for rengjøring / Garanti / Kontakt
- BG** Препоръка за почистване / Гаранция / Контакт
- SQ** Këshilla rreth pastrimit / Garancia / Kontakt
- KO** 세정시 권장사항 / 품질보증 / 접촉
- AR** توصيات التنظيف / الضمان (الولايات المتحدة الأمريكية) / اتصال



www.hansgrohe.com/cleaning-recommendation

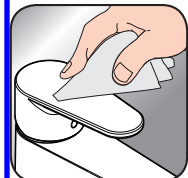

www.hansgrohe.com/cleaning-recommendation



www.hansgrohe.com/cleaning-recommendation



www.hansgrohe.com/cleaning-recommendation

Service

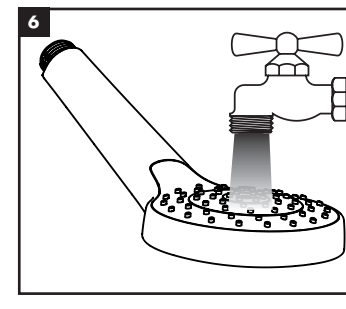
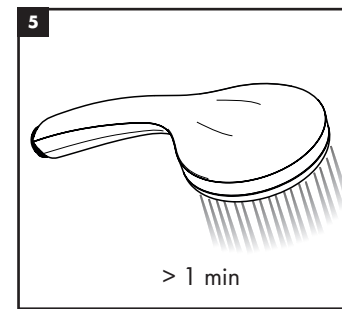
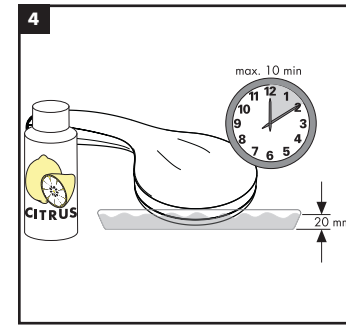
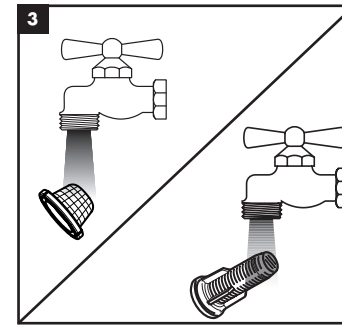
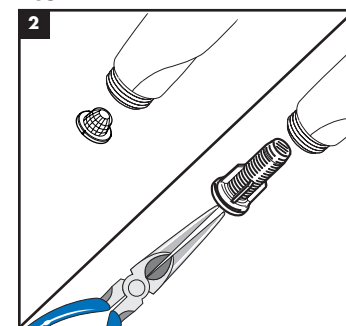
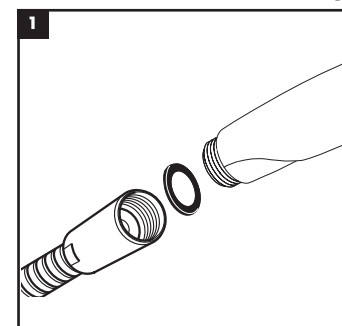

4

DE Montageanleitung

FR Instructions de montage

EN assembly instructions

IT Istruzioni per l'installazione

ES Instrucciones de montaje

NL Handleiding

DK Monteringsvejledning

PT Manual de Instalação

PL Instrukcja montażu

CS Montážní návod

SK Montážny návod

ZH 组装说明

RU Инструкция по монтажу

HU Szerelési útmutató

FI Asennusohje

SV Monteringsanvisning

LT Montavimo instrukcijos

HR Uputstva za instalaciju

TR Montaj kılavuzu

RO Instrucțiuni de montare

EL Οδηγία συναρμολόγησης

SL Navodila za montažo

ET Paigaldusjuhend

LV Montāžas instrukcija

SR Uputstvo za montažu

NO Montasjeveiledning

BG Инструкция за употреба

SQ Udhëzime rreth montimit

AR تعليمات التجميع

02/2019
9.02744.04

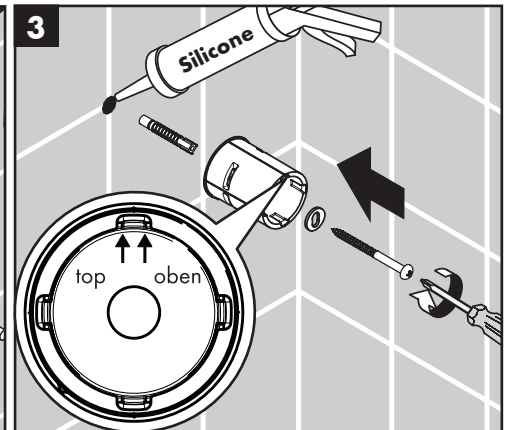
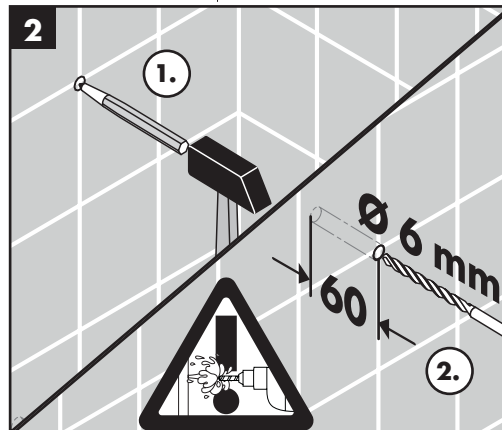
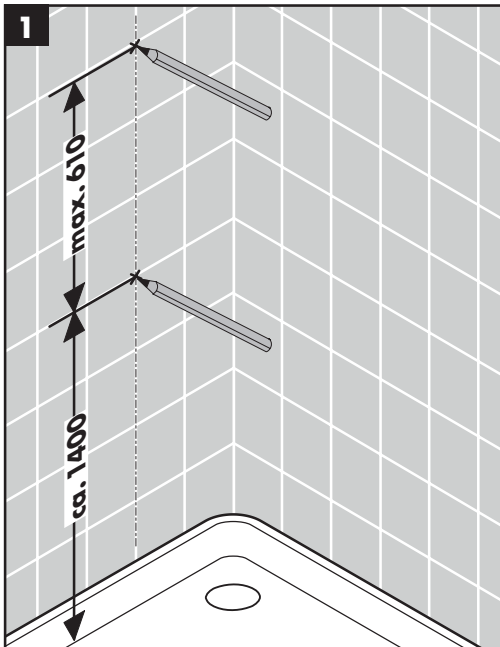
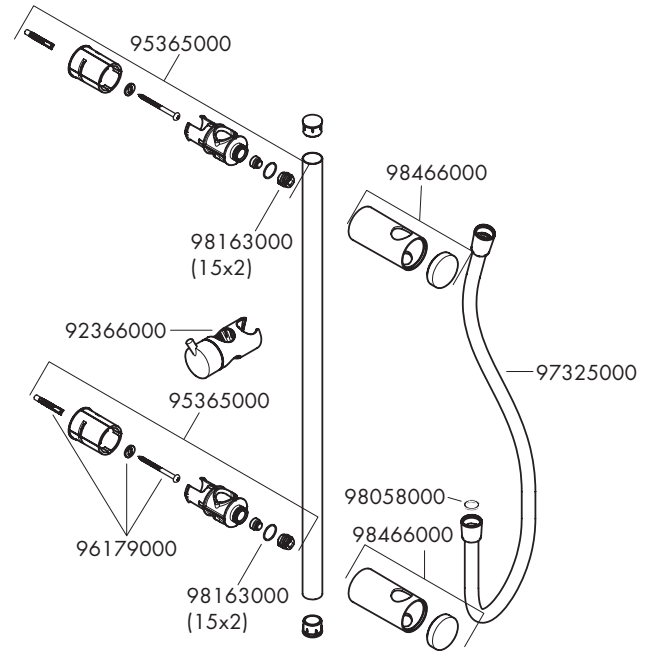
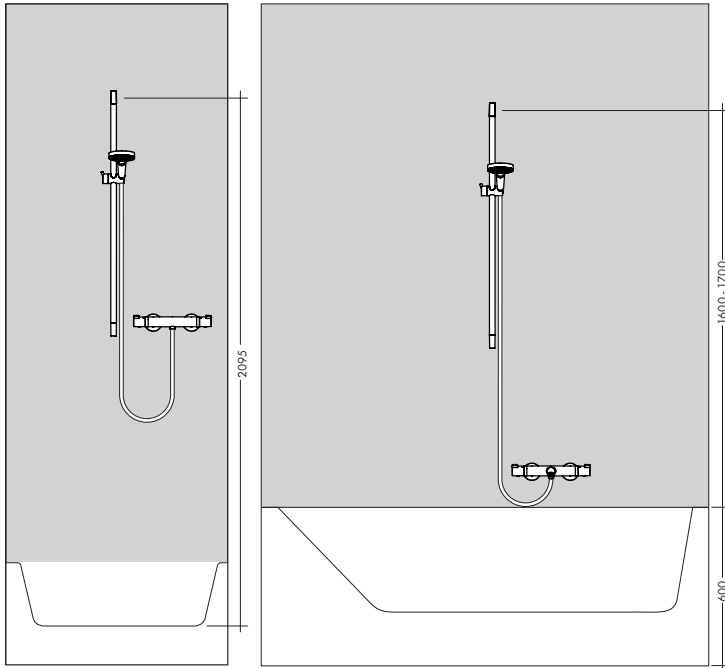

Silikon (essigsäurefrei!) / Silicone (sans acide acétique!) / Silicone (free from acetic acid!) / Silicone (esente da acido acetico!) / Silicona (l libre de ácido acético!) / Silicone (azijnzuurvrij!) / Silikone (eddikesyre-fri) / Silicone (sem ácido acético) / Silikon (neutralny) / Silikon (bez kyseliny octové!) / Silikon (bez kyseliny octovej!) / 硅胶 (不含醋酸) / Силикон (не содержит уксусной кислоты!) / Szilikon (ecetsavmentes!) / Silikoni (etiikkahappovapaat!) / Silikon (fri från ättiksyra!) / Silikonas (be acto rūgšties!) / Silikon (ne sadrži kiseline) / Silikon (asetik asit içermeyen) / Silicon (fără acid acetic!) / Σιλικόνη (δίχως οξικό οξύ!) / Silikon (brez ocetne kisline) / Silikoon (äädikhappeta!) / Silikons (etiškābi nesaturōšis!) / Silikon (ne sadrži sirćetnu kiselinu!) / Silikon (uten eddiksyre) / Силикон (без оцетна киселина!) / Silikon (pa acid uthulle!) / (سيليكون خالي من حمض الخليك!)

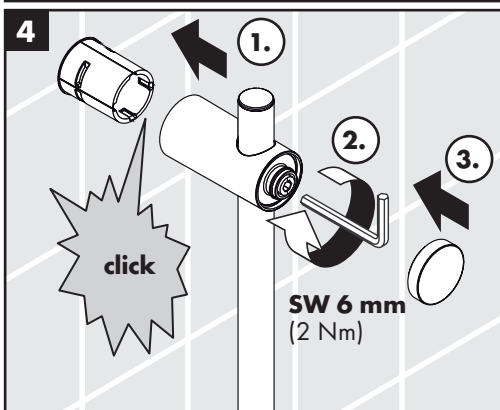

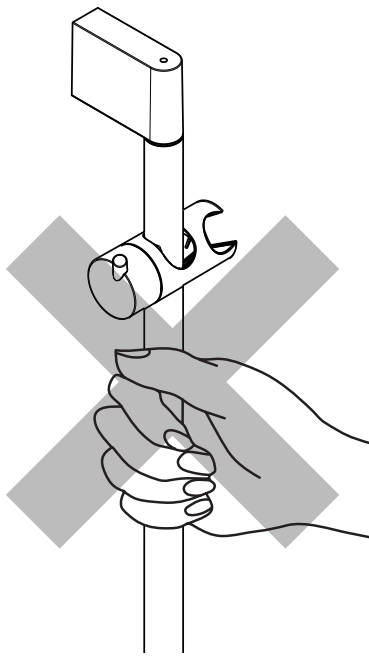

- CS** Produkt nesmí být používán jako madlo.
- SK** Výrobok sa nesmie používať ako držadlo.
- ZH** 该产品不得作扶柄使用。
- RU** Изделие запрещается использовать в качестве рукоятки.
- HU** A terméket nem szabad karaszkodónak használni.
- FI** Tuotetta ei saa käyttää kädensijana.
- SV** Produkten får inte användas som handtag.
- LT** Gaminys neturi būti naudojamas kaip rankena.
- HR** Proizvod ne smije služiti za pridržavanje.
- TR** Ürün tutma kolu olarak kullanılmamalıdır.
- RO** Nu este permisă utilizarea produsului pe post de mâner.

DE Das Produkt darf nicht als Haltegriff benutzt werden.

FR Le produit ne doit pas servir de poignée.

EN The product may not be used as a holding handle.

IT Il prodotto non deve essere utilizzato come maniglia

ES El producto no debe ser utilizado como un elemento de sujeción.

NL Het product mag niet als handgreep worden gebruikt.

DK Produktet må ikke bruges som håndtag.

PT O produto não pode ser utilizado como pega de apoio.

PL Produktu nie wolno używać jako uchwytu do trzymania się.

EL Το προϊόν δεν επιτρέπεται να χρησιμοποιείται σαν λαβή στήριξης.

SL Proizvoda ne smete uporabljati kot drzalnega ročaja.

ET Toode ei tohi kasutada käepidemena.

LV Šo produktu nedrīkst izmantot kā roku balstu.

SR Proizvod se ne sme koristiti za kao ručka za pridržavanje.

NO Produktet skal ikke brukes som holdegrep.

BG Продуктът не бива да се използва като дръжка.

SQ Produkti nuk duhet të përdoret si dorëze mbajtëse.

AR ضيقك جتنملا مادختس! عون لصفنم ضيقم بيكرت بجي.

- DE** Reinigungsempfehlung / Garantie / Kontakt
- FR** Recommandation pour le nettoyage / Garanties / Contact
- EN** Cleaning recommendation / Warranty / Contact
- IT** Raccomandazione di pulizia / Garanzia / Contatto
- ES** Recomendaciones para la limpieza / Garantía / Contacto
- NL** Aanbevelingen inzake reiniging / Garantie / Contact
- DK** Rensning, anbefaling / Garanti / Kontakt
- PT** Recomendações de limpeza / Garantia / Contacto
- PL** Zalecenie dotyczące pielęgnacji / Gwarancja / Kontakt
- CS** Doporučení k čištění / Záruka / Kontakt
- SK** Odporúčania pre čistenie / Záruka / Kontakt
- ZH** 清洁指南 / 担保 / 接触
- RU** Рекомендации по очистке / Гарантия / Контакты
- HU** Tisztítási tanácsok / Garancia / érintkezés
- FI** Puhdistussuositus / Takuu / Kosketus
- SV** Rengöringsrekommendationer / Garanti / Contacto
- LT** Valymo rekomendacijos / Garantija / Kontaktai
- HR** Preporuke za čišćenje / Garancija / Kontakt
- TR** Temizleme önerisi / Garanti / Temas
- RO** Recomandări pentru curățare / Garanție / Contact
- EL** Σύσταση καθαρισμού / Εγγύηση / επαφή
- SL** Priporočilo za čiščenje / Garancija / Kontakt
- ET** Puhastussuovitused / Garantii / Kontakt
- LV** Tīrīšanas ieteikumi / Garantija / Kontakti
- SR** Preporuke za čišćenje / Garancija / Kontakt
- NO** Anbefaling for rengjøring / Garanti / Kontakt
- BG** Препоръка за почистване / Гаранция / Контакт
- SQ** Këshilla rreth pastrimit / Garancia / Kontakt
- KO** 세정시 권장사항 / 품질보증 / 접촉
- AR** توصيات التنظيف / الضمان (الولايات المتحدة الأمريكية) / اتصال



www.hansgrohe.com/cleaning-recommendation

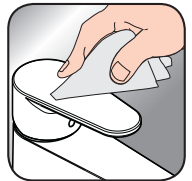

www.hansgrohe.com/cleaning-recommendation



www.hansgrohe.com/cleaning-recommendation



www.hansgrohe.com/cleaning-recommendation

Classification acoustique et débit: **ACS**

26711400 / 26715400 / 26713400 / 26712400 / 26714400 / 26717400 / 26750400 / 26751400 / 26752400 / 26709402 / 26796402

