

**hansgrohe**

Hansgrohe · Auestraße 5 · 9 · D-77761 Schiltach  
Telefon +49 (0) 78 36/51-1282 · Telefax +49 (0) 7836/511440  
E-Mail: info@hansgrohe.com · Internet: www.hansgrohe.com

03/2018  
9.02429.06

**hansgrohe**

- DE** Montageanleitung  
**FR** Instructions de montage  
**EN** assembly instructions  
**IT** Istruzioni per Installazione  
**ES** Instrucciones de montaje  
**NL** Handleiding  
**DK** Monteringsvejledning  
**PT** Manual de Instalação  
**PL** Instrukcja montażu  
**CS** Montážní návod  
**SK** Montážny návod  
**ZH** 组装说明  
**RU** Инструкция по монтажу  
**HU** Szerelési útmutató  
**FI** Asennusohje  
**SV** Monteringsanvisning  
**LT** Montavimo instrukcijos  
**HR** Uputstva za instalaciju  
**TR** Montaj kılavuzu  
**RO** Instrucțiuni de montare  
**EL** Οδηγία συναρμολόγησης  
**SI** Navodila za montažo  
**ET** Paigaldusjuhend  
**LV** Montāžas instrukcija  
**SR** Uputstvo za montažu  
**NO** Montasjeveiledning  
**BG** Инструкция за употреба  
**SQ** Udhëzime rreth montimit  
**AR** تعليمات التجميع

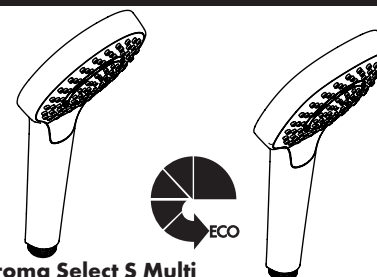

**Croma Select S Multi**

26801400

**Croma Select S Vario**

26803400

**Croma Select S 1jet**

26805400 /

26806400

**Croma Select E Multi**

26811400

**Croma Select E Vario**

26813400

**Croma Select E 1jet**

26815400 /

26816400

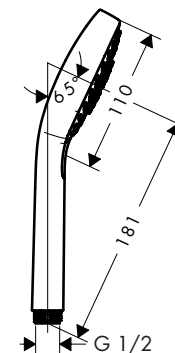

**Croma Select S Multi**

26801400

**Croma Select S Vario**

26803400

**Croma Select S 1jet**

26805400 /

26806400

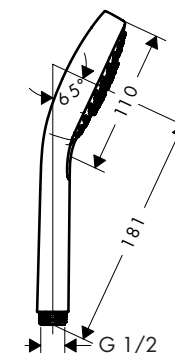

**Croma Select E Multi**

26811400

**Croma Select E Vario**

26813400

**Croma Select E 1jet**

26815400 /

26816400

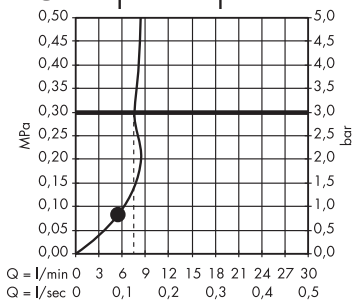
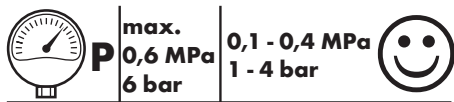

**Croma Select S 1jet 26805400**  
**Croma Select E 1jet 26815400**

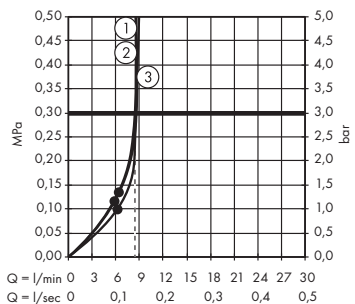

**Croma Select S Vario 26803400**  
**Croma Select E Vario 26813400**



2

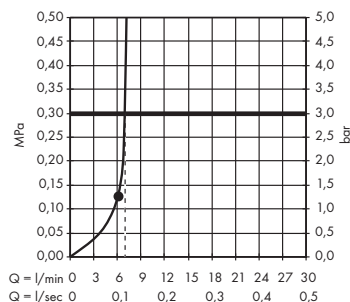

**Croma Select S 1jet 26806400**  
**Croma Select E 1jet 26816400**

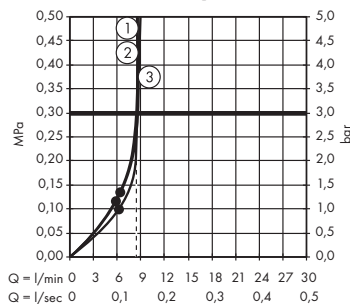

**Croma Select S Multi 26801400**  
**Croma Select E Multi 26811400**

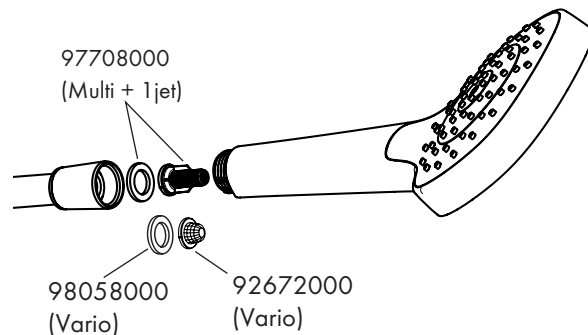
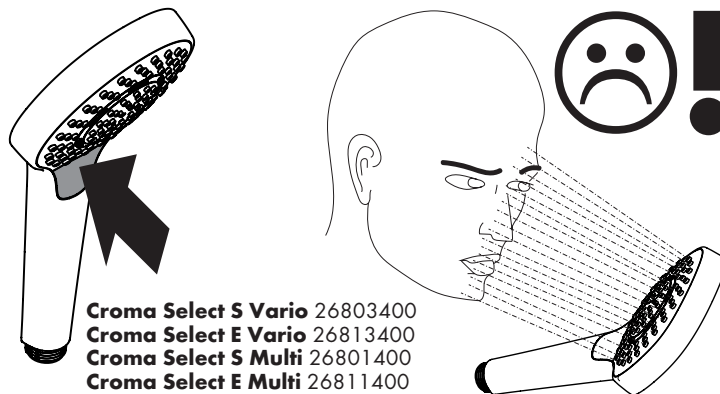

**P-IX ACS KIWA WRAS**

<b>26801400</b>	P-IX 28499/IB	X	X	X
<b>26803400</b>	P-IX 28500/IB	X	X	X
<b>26805400</b>	P-IX 28501/IB	X	X	X
<b>26806400</b>	P-IX 28501/IB	X	X	X
<b>26811400</b>	P-IX 28502/IB	X	X	X
<b>26813400</b>	P-IX 28503/IB	X	X	X
<b>26815400</b>	P-IX 28504/IB	X	X	X
<b>26816400</b>	P-IX 28504/IB	X	X	X

3

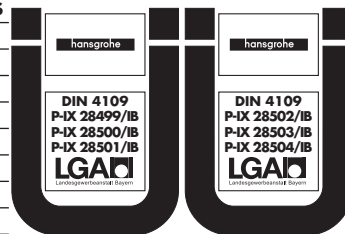

- DE** Reinigungsempfehlung / Garantie / Kontakt  
**FR** Recommendation pour le nettoyage / Garanties / Contact  
**EN** Cleaning recommendation / Warranty / Contact  
**IT** Raccomandazione di pulizia / Garanzia / Contatto  
**ES** Recomendaciones para la limpieza / Garantía / Contacto  
**NL** Aanbevelingen inzake reiniging / Garantie / Contact  
**DK** Rensning, anbefaling / Garanti / Kontakt  
**PT** Recomendações de limpeza / Garantia / Contacto  
**PL** Zalecenie dotyczące pielęgnacji / Gwarancja / Kontakt  
**CS** Doporučení k čištění / Záruka / Kontakt  
**SK** Odporúčania pre čistenie / Záruka / Kontakt  
**ZH** 清洁指南 / 担保 / 接触  
**RU** Рекомендации по очистке / Гарантия / Контакты  
**HU** Tisztítási tanácsok / Garancia / érintkezés  
**FI** Puhdistussuositus / Takuu / Kosketus  
**SV** Rengöringsrekommendationer / Garanti / Contacto  
**LT** Valymo rekomendacijos / Garantija / Kontaktai  
**HR** Preporuke za čišćenje / Garancija / Kontakt  
**TR** Temizleme önerisi / Garanti / Temas  
**RO** Recomandări pentru curățare / Garanție / Contact  
**EL** Σύσταση καθαρισμού / Εγγύηση / επαφή  
**SL** Priporočilo za čiščenje / Garancija / Kontakt  
**ET** Puhastussuovitused / Garantii / Kontakt  
**LV** Tīrīšanas ieteikumi / Garantija / Kontakti  
**SR** Preporuke za čišćenje / Garancija / Kontakt  
**NO** Anbefaling for rengjøring / Garanti / Kontakt  
**BG** Препоръка за почистване / Гаранция / Контакт  
**SQ** Këshilla rreth pastrimit / Garancia / Kontakt  
**KO** 세정시 권장사항 / 품질보증 / 접촉  
**AR** توصيات التنظيف / الضمان (الولايات المتحدة الأمريكية) / اتصال



www.hansgrohe.com/  
cleaning-recommendation

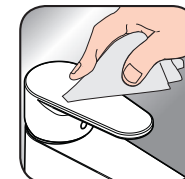

www.hansgrohe.com/  
cleaning-recommendation



www.hansgrohe.com/  
cleaning-recommendation



www.hansgrohe.com/  
cleaning-recommendation

4

**DE** Montageanleitung

**FR** Instructions de montage

**EN** assembly instructions

**IT** Istruzioni per l'installazione

**ES** Instrucciones de montaje

**NL** Handleiding

**DK** Monteringsvejledning

**PT** Manual de Instalação

**PL** Instrukcja montażu

**CS** Montážní návod

**SK** Montážny návod

**ZH** 组装说明

**RU** Инструкция по монтажу

**HU** Szerelési útmutató

**FI** Asennusohje

**SV** Monteringsanvisning

**LT** Montavimo instrukcijos

**HR** Uputstva za instalaciju

**TR** Montaj kılavuzu

**RO** Instrucțiuni de montare

**EL** Οδηγία συναρμολόγησης

**SL** Navodila za montažo

**ET** Paigaldusjuhend

**LV** Montāžas instrukcija

**SR** Uputstvo za montažu

**NO** Montasjeveiledning

**BG** Инструкция за употреба

**SQ** Udhëzime rreth montimit

**AR** تعليمات التجميع

09/2018  
9.05046.04

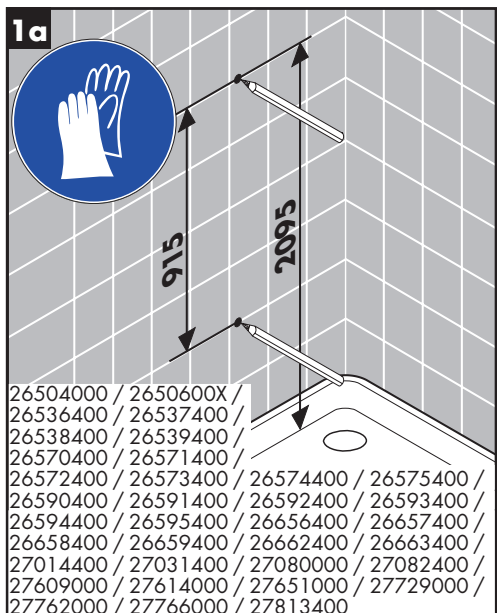
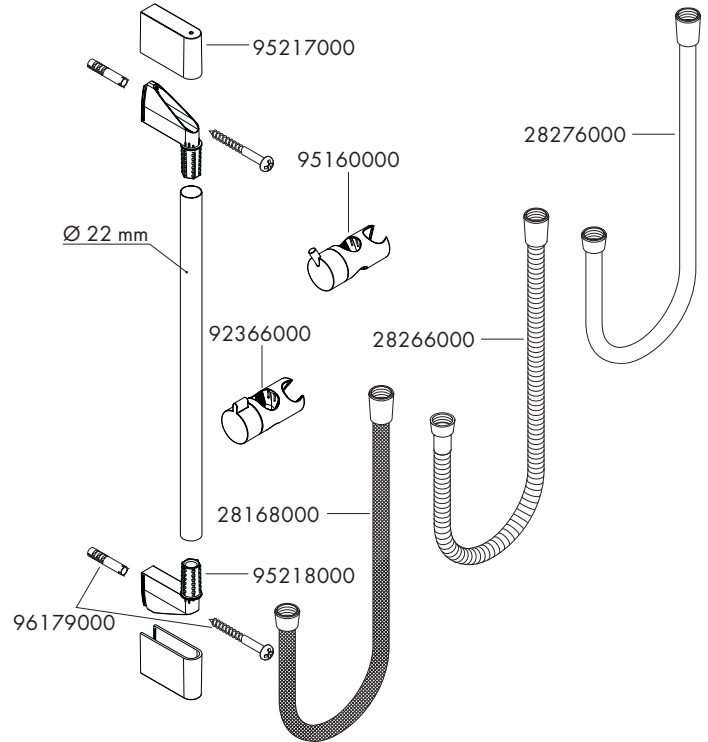
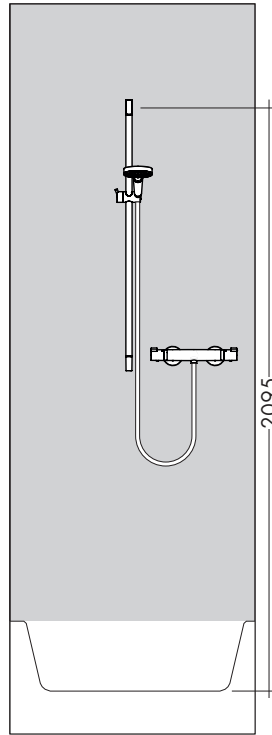
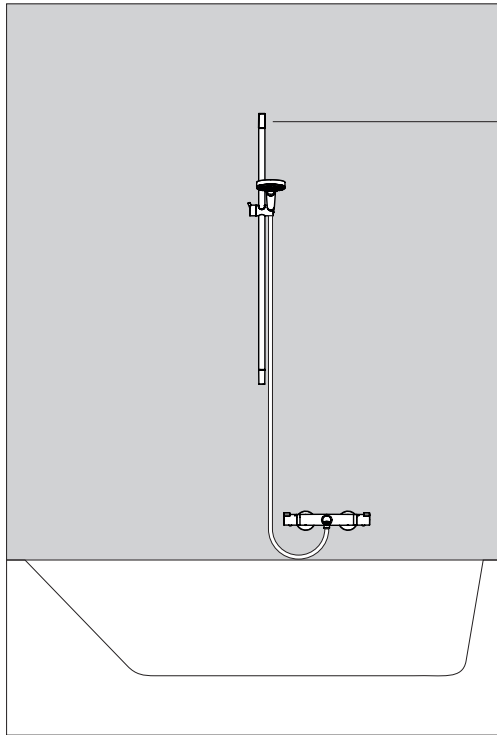

26504000 / 2650600X /  
26536400 / 26537400 /  
26538400 / 26539400 /  
26570400 / 26571400 /  
26572400 / 26573400 /  
26590400 / 26591400 /  
26594400 / 26595400 /  
26658400 / 26659400 /  
27014400 / 27031400 /  
27609000 / 27614000 /  
27762000 / 27766000 /  
26574400 / 26575400 /  
26592400 / 26593400 /  
26656400 / 26657400 /  
26662400 / 26663400 /  
27080000 / 27082400 /  
27751000 / 27729000 /  
27813400

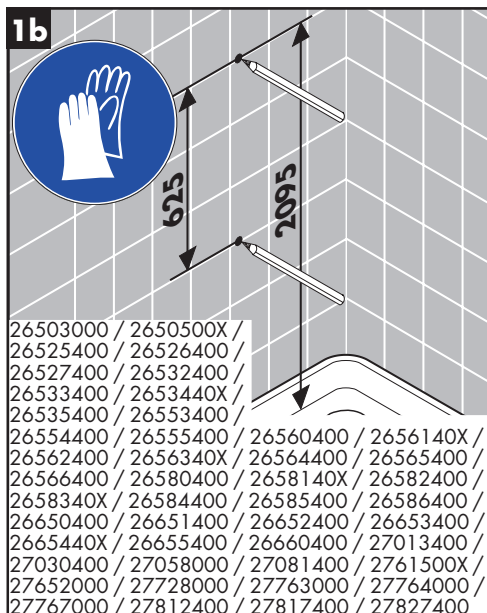

26503000 / 2650500X /  
26525400 / 26526400 /  
26527400 / 26532400 /  
26533400 / 2653440X /  
26535400 / 26553400 /  
26554400 / 26555400 /  
26562400 / 2656340X /  
26566400 / 26580400 /  
2658340X / 26584400 /  
26650400 / 26651400 /  
2665440X / 26655400 /  
27030400 / 27058000 /  
27652000 / 27728000 /  
27767000 / 27812400 /  
26560400 / 2656140X /  
26564400 / 26565400 /  
2658140X / 26582400 /  
26585400 / 26586400 /  
26652400 / 26653400 /  
26660400 / 27013400 /  
27081400 / 2761500X /  
27763000 / 27764000 /  
27817400 / 27827400

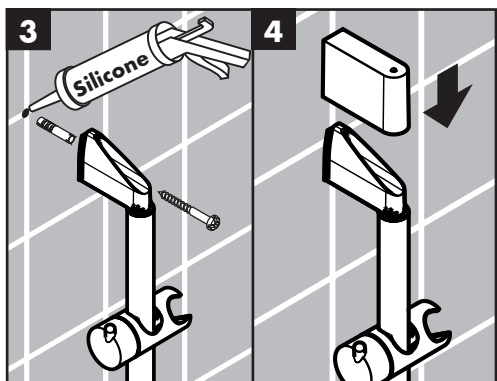
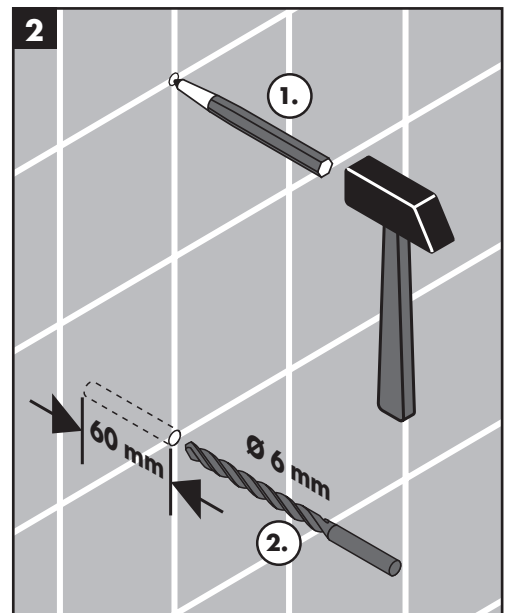

Silikon (essigsäurefrei!)  
Silicone (sans acide acétique!)  
Silicone (free from acetic acid!)  
Silicone (esente da acido acetico!)  
Silicona (¡libre de ácido acético!)  
Silicone (azijnzuurvrij!)  
Silikone (eddikesyre-fri)  
Silicone (sem ácido acético)  
Silikon (neutralny)  
Silikon (bez kyseliny octové!)  
Silikon (bez kyseliny octovej!)  
硅胶 (不含醋酸)  
Силикон (не содержит уксусной кислоты!)  
Szikon (ecetsavmentes!)  
Silikoni (etikahappovapaa!)  
Silikon (fri från ättiksyra!)

Silikonas (be acto rūgšties!)  
Silikon (ne sadrži kisliline)  
Silikon (asetik asit içermeyen)  
Silicon (fără acid acetic!)  
Σιλικόνη (δίχως οξικό οξύ!)  
Silikon (brez ocetne kisline)  
Silikoon (äädikhappeta!)  
Silikons (etiikskäbi nesaturošs!)  
Silikon (ne sadrži sircetnu kiselinu!)  
Silikon (uten eddiksyre)  
Силикон (без оцетна киселина!)  
Silikon (pa acid utulle!)  
سيليكون (خالي من حمض الخليك!)

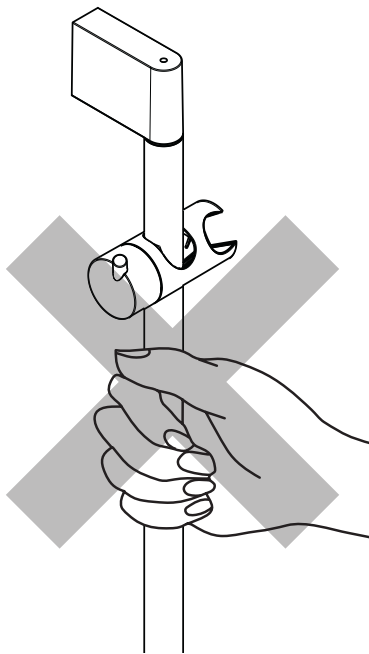

- CS** Produkt nesmí být používán jako madlo.
- SK** Výrobok sa nesmie používať ako držadlo.
- ZH** 该产品不得作扶柄使用。
- RU** Изделие запрещается использовать в качестве рукоятки.
- HU** A terméket nem szabad kapaszkodónak használni.
- FI** Tuotetta ei saa käyttää kädensijana.
- SV** Produkten får inte användas som handtag.
- LT** Gaminy nes turi būti naudojamas kaip rankena.
- HR** Proizvod ne smije služiti za pridržavanje.
- TR** Ürün tutma kolu olarak kullanılmamalıdır.
- RO** Nu este permisă utilizarea produsului pe post de mâner.
- EL** Το προϊόν δεν επιτρέπεται να χρησιμοποιείται σαν λαβή στήριξης.
- SL** Proizvoda ne smete uporabljati kot drzalnega ročaja.
- ET** Toode ei tohi kasutada käepidemena.
- LV** Šo produktu nedrīkst izmantot kā roku balstu.
- SR** Proizvod se ne sme koristiti za kao ručka za pridržavanje.
- NO** Produktet skal ikke brukes som holdegrep.
- BG** Продуктът не бива да се използва като дръжка.
- SQ** Produkti nuk duhet të përdoret si dorëze mbajtëse.
- AR** ممنوع استخدام المنتج كمقبض.

- DE** Das Produkt darf nicht als Haltegriff benutzt werden.
- FR** Le produit ne doit pas servir de poignée.
- EN** The product may not be used as a holding handle.
- IT** Il prodotto non deve essere utilizzato come maniglia
- ES** El producto no debe ser utilizado como un elemento de sujeción.
- NL** Het product mag niet als handgreep worden gebruikt.
- DK** Produktet må ikke bruges som håndtag.
- PT** O produto não pode ser utilizado como pega de apoio.
- PL** Produktu nie wolno używać jako uchwytu do trzymania się.

- DE** Reinigungsempfehlung / Garantie / Kontakt
- FR** Recommandation pour le nettoyage / Garanties / Contact
- EN** Cleaning recommendation / Warranty / Contact
- IT** Raccomandazione di pulizia / Garanzia / Contatto
- ES** Recomendaciones para la limpieza / Garantía / Contacto
- NL** Aanbevelingen inzake reiniging / Garantie / Contact
- DK** Rensning, anbefaling / Garanti / Kontakt
- PT** Recomendações de limpeza / Garantia / Contacto
- PL** Zalecenie dotyczące pielęgnacji / Gwarancja / Kontakt
- CS** Doporučení k čištění / Záruka / Kontakt
- SK** Odporúčania pre čistenie / Záruka / Kontakt
- ZH** 清洁指南 / 担保 / 接触
- RU** Рекомендации по очистке / Гарантия / Контакты
- HU** Tisztítási tanácsok / Garancia / érintkezés
- FI** Puhdistussuositus / Takuu / Kosketus
- SV** Rengöringsrekommendationer / Garanti / Contacto
- LT** Valymo rekomendacijos / Garantija / Kontaktai
- HR** Preporuke za čišćenje / Garancija / Kontakt
- TR** Temizleme önerisi / Garanti / Temas
- RO** Recomandări pentru curățare / Garanție / Contact
- EL** Σύσταση καθαρισμού / Εγγύηση / επαφή
- SL** Priporočilo za čiščenje / Garancija / Kontakt
- ET** Puhastussuositused / Garantii / Kontakt
- LV** Tīrīšanas ieteikumi / Garantija / Kontakti
- SR** Preporuke za čišćenje / Garancija / Kontakt
- NO** Anbefaling for rengjøring / Garanti / Kontakt
- BG** Препоръка за почистване / Гаранция / Контакт
- SQ** Këshilla rreth pastrimit / Garancia / Kontakt
- KO** 세정시 권장사항 / 품질보증 / 접촉
- AR** توصيات التنظيف / الضمان (الولايات المتحدة الأمريكية) / اتصال



www.hansgrohe.com/  
cleaning-recommendation

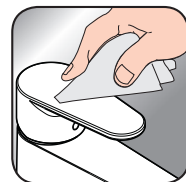

www.hansgrohe.com/  
cleaning-recommendation



www.hansgrohe.com/  
cleaning-recommendation



www.hansgrohe.com/  
cleaning-recommendation

#### Classification acoustique et débit: **ACS**

26503000 / 26504000 / 26525400 / 26526400 / 26527400 / 26532400 / 26533400 / 26534400 /  
26535400 / 26536400 / 26537400 / 26538400 / 26539400 / 26553400 / 26554400 / 26555400 /  
26560400 / 26561400 / 26562400 / 26563400 / 26564400 / 26565400 / 26566400 / 26570400 /  
26571400 / 26572400 / 26573400 / 26574400 / 26580400 / 26581400 / 26582400 / 26583400 /  
26584400 / 26585400 / 26590400 / 26591400 / 26592400 / 26593400 / 26594400 / 26595400 /  
26657400 / 27013400 / 27014400 / 27058000 / 27080000 / 27081400 / 27082400 / 27728000 /  
27729000 / 27762000 / 27763000 / 27764000 / 27766000 / 27767000

