

QUICKFIX

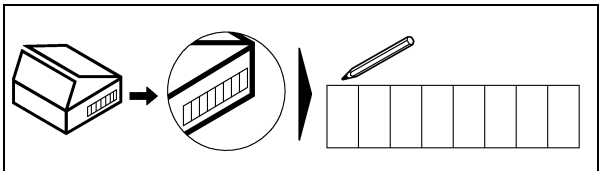

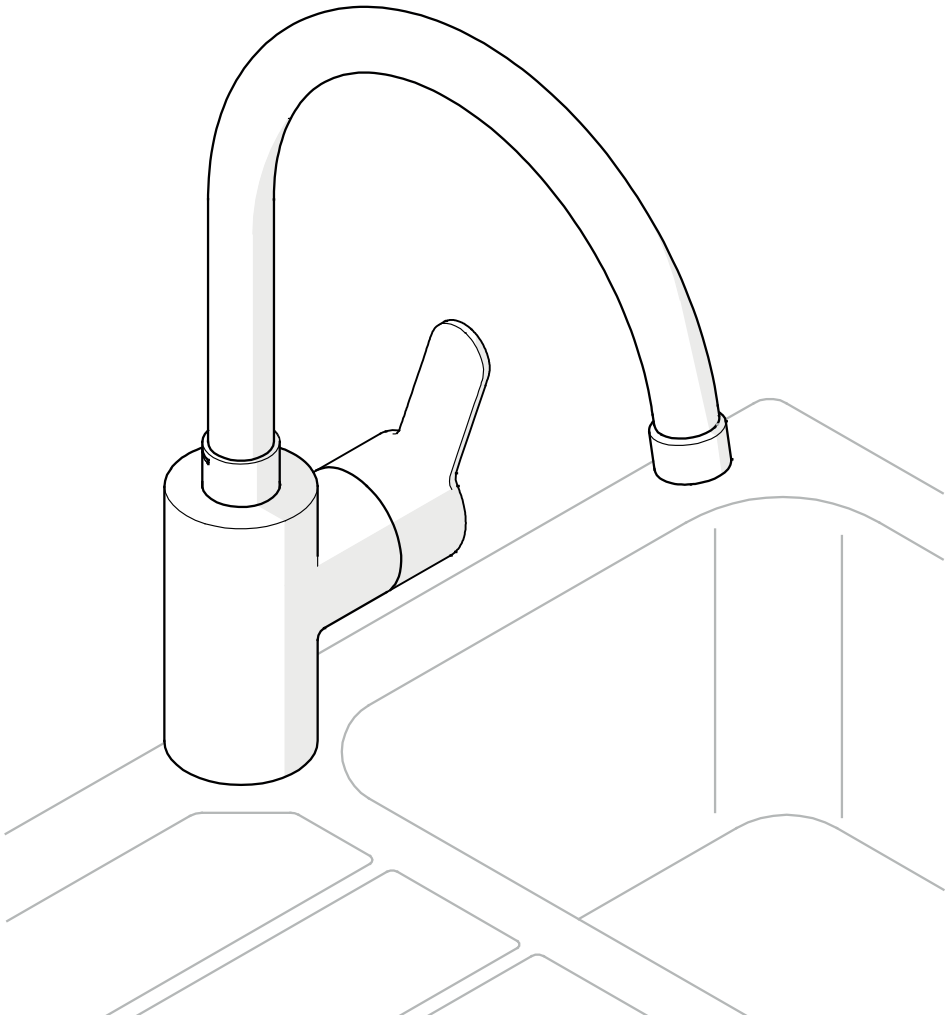
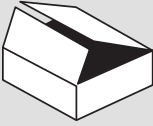
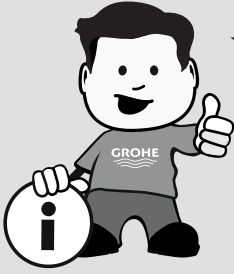

DIN 1988 !

DIN EN 1717 !

DIN EN 806 !



min. 0,5 bar
max. 10 bar
1-5 bar ✓



max. 70 °C
60 °C ✓



1

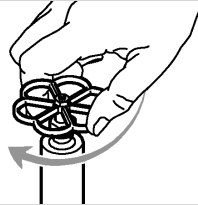

2

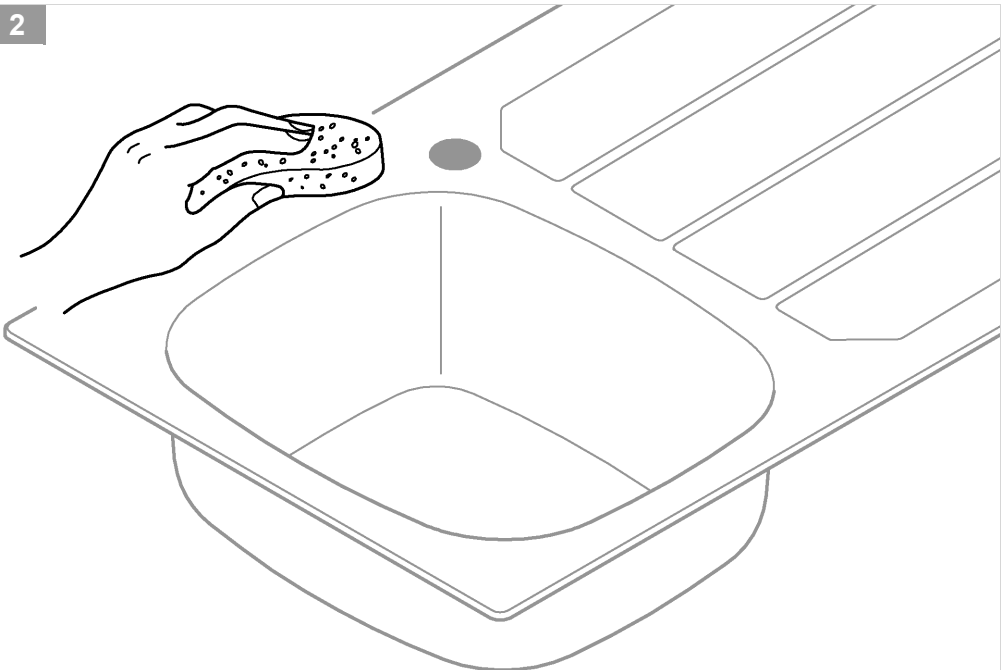

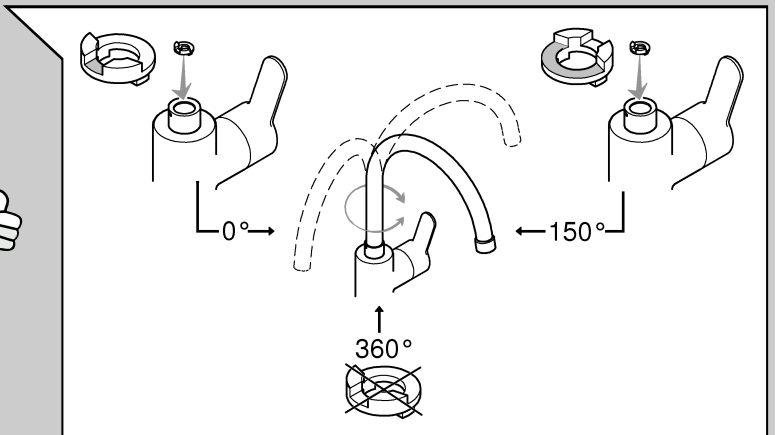
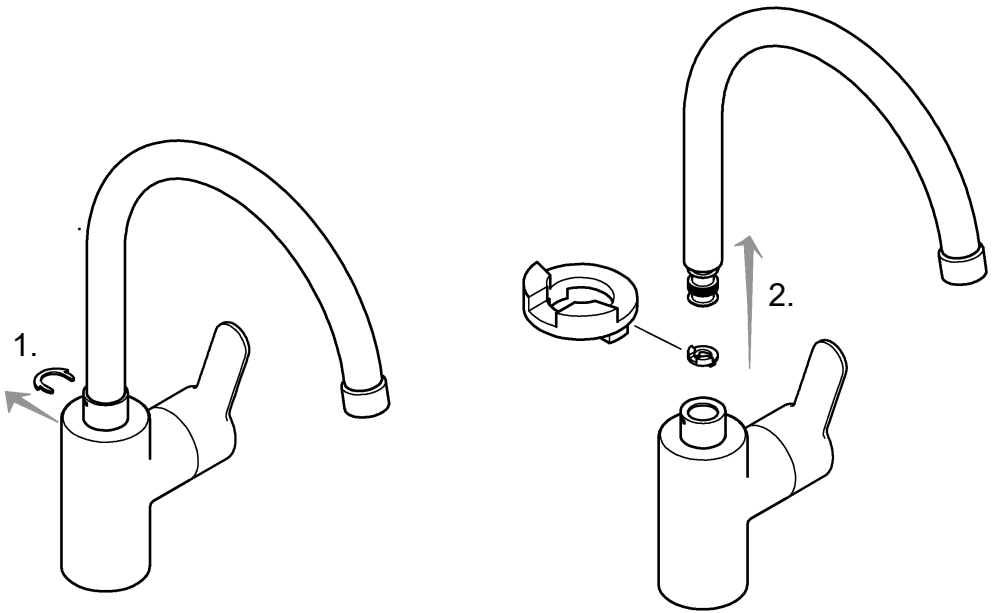

3

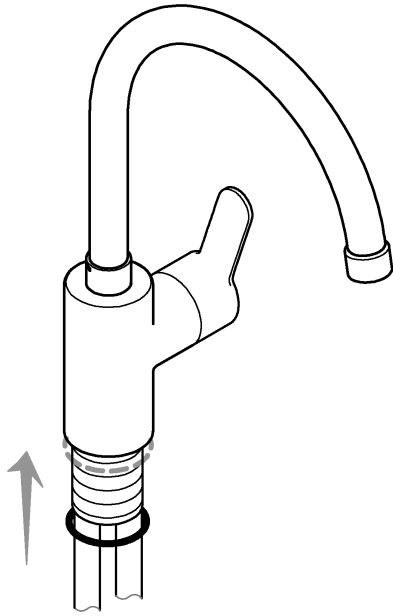

4

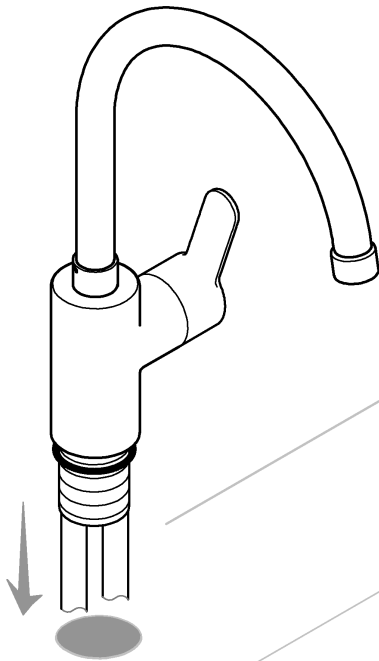

5

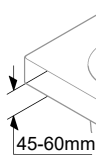
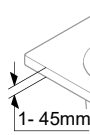
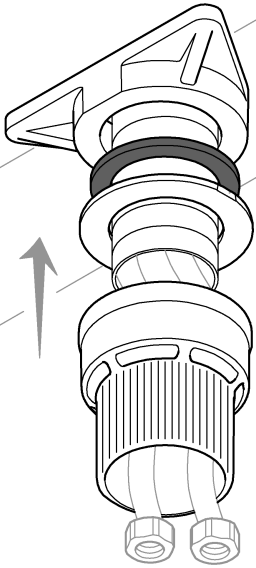

6

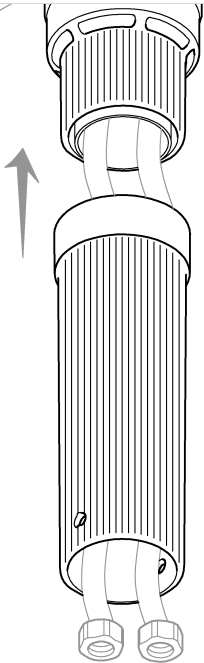

7

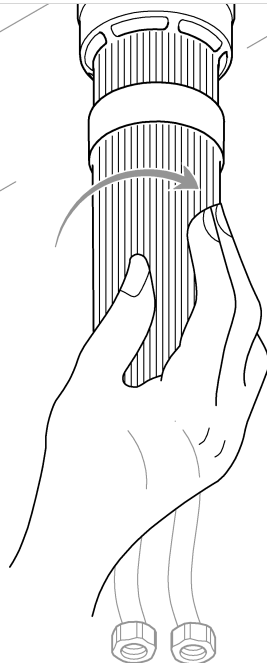

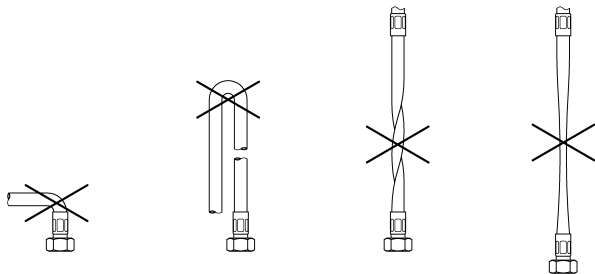
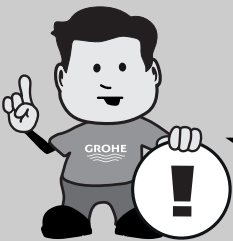
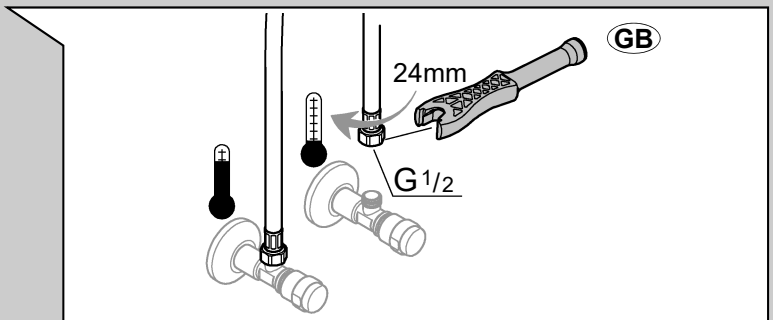
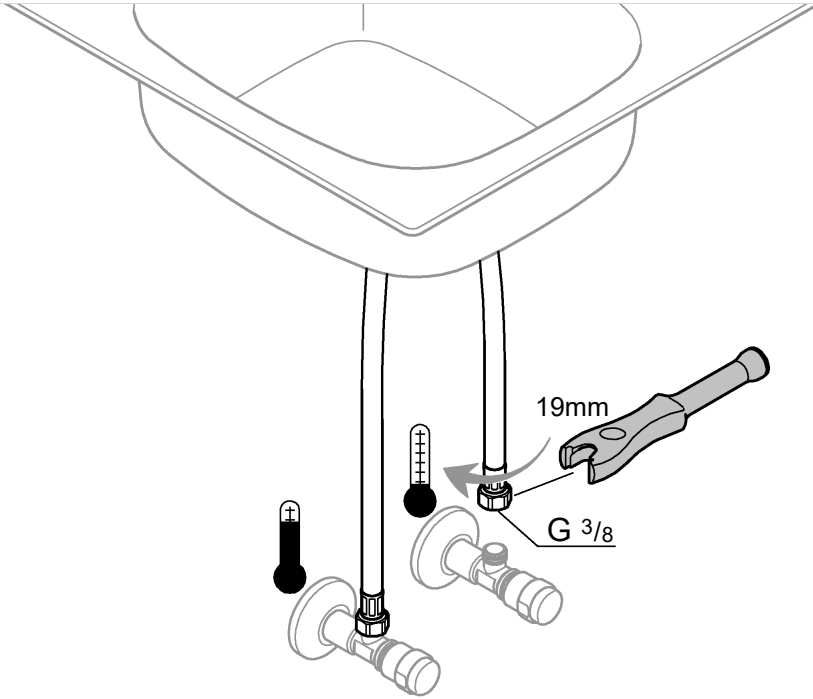

9

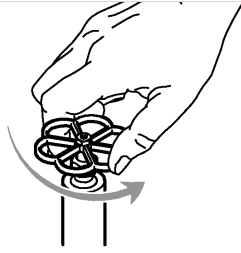

10

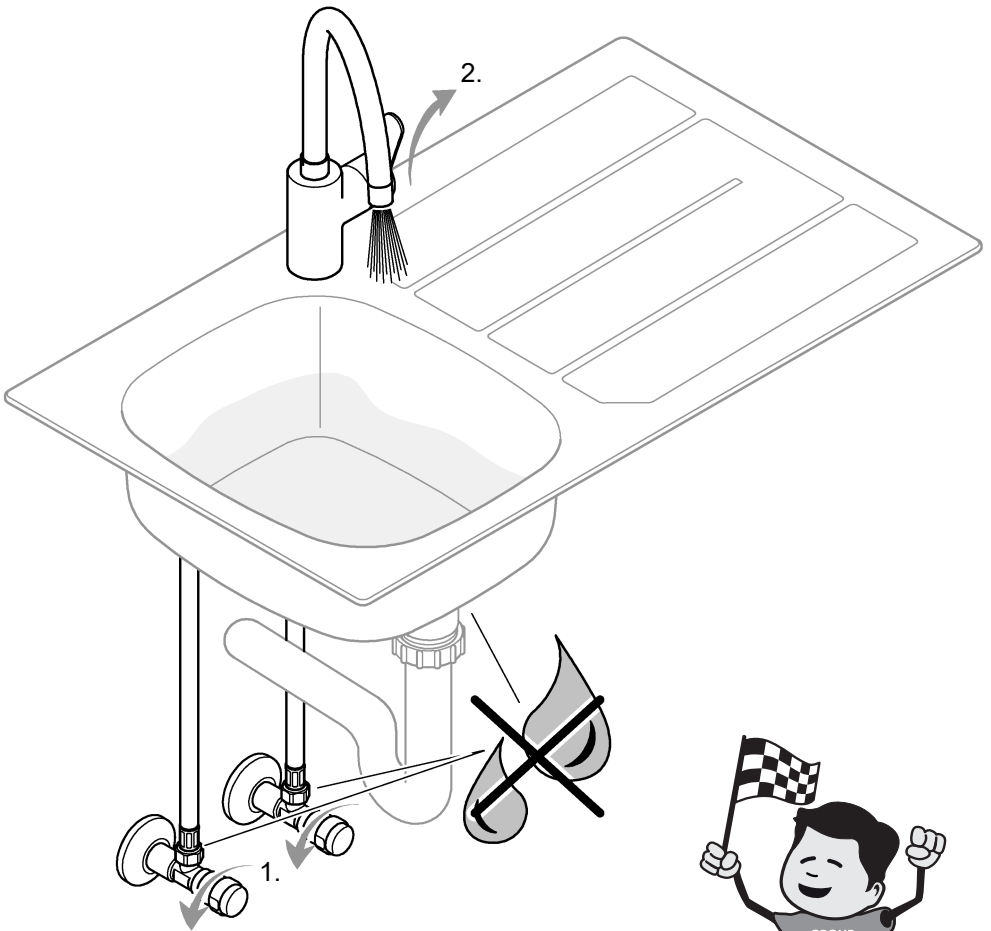

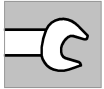
D

Die Installation muss entsprechend den geltenden örtlichen Bau- und Installationsvorschriften ausgeführt werden. Bei Fragen bitte einen Fachmann kontaktieren.

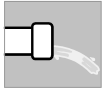

Vor der Installation sollte man Wasser durch die Leitung laufen lassen, um eventuelle Rückstände zu beseitigen. Eine Beschädigung des Produktes kann so vermieden werden.

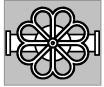

Hauptahn der Wasserzufuhr vor dem Auswechseln der Armatur abdrehen.



VORSICHT!
Schraubverbindungen auch mit eingelegerter Dichtung nicht zu fest anziehen, um Beschädigungen zu vermeiden.

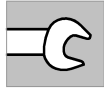

Regelmäßig kontrollieren, dass die Installation dicht ist.

GB

Installation must be performed in compliance with applicable local construction and plumbing regulations. If in doubt, contact an expert.

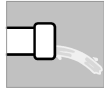

Before installation, water should be rinse through the pipe to remove any residue. Damage on the product can be avoided.

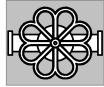

Before changing the fitting switch off main shut-off valve.



"CAUTION!
Do not overtighten screw connections, even with the seal inserted, to avoid damage."

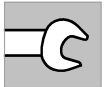

Check at regular intervals to make sure that the installation is not leaking.

F

L'installation doit être réalisée conformément aux réglementations locales de construction et d'installation. Si vous avez des questions, merci de contacter un spécialiste.

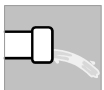

Laisser couler l'eau dans les tuyaux avant l'installation de manière à éliminer d'éventuels résidus. Cette précaution permet d'éviter l'endommagement du produit.

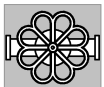

Avant de procéder au remplacement du robinet, fermer l'arrivée d'eau principale.



"ATTENTION !
Pour éviter tout dommage, ne pas trop serrer les vis, même munies d'un joint."

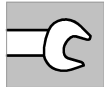

Contrôler régulièrement l'étanchéité de l'installation.

E

La instalación debe realizarse según las normativas locales en vigor de construcción e instalación. En caso de duda, póngase en contacto con un especialista.

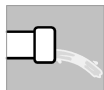

Antes de la instalación, debe dejar fluir el agua por la tubería para eliminar los posibles restos. De ese modo podrá evitar desperfectos en el producto.

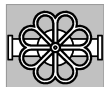

Cierre la llave principal de la alimentación de agua antes de cambiar el grifo.



"CUIDADO:
No apriete con demasiada fuerza las uniones roscadas, incluso si está colocada la junta, a fin de evitar desperfectos."

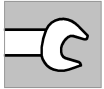

Compruebe con regularidad que la instalación sea estanca.

I

L'installazione deve essere effettuata in conformità alle norme locali in vigore per la costruzione e l'installazione. Per eventuali domande rivolgersi a un tecnico.

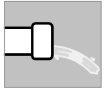

Prima dell'installazione si dovrebbe lasciar scorrere l'acqua dal lavandino per eliminare eventuali residui. In questo modo è possibile evitare un danneggiamento del prodotto.

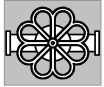

Prima di sostituire il rubinetto, chiudere il rubinetto principale dell'erogazione dell'acqua.



"ATTENZIONE!

Non serrare troppo a fondo i raccordi a vite anche con guarnizione inserita per evitarne eventuali danni."

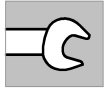

Controllare regolarmente che l'installazione sia a tenuta.

NL

De installatie moet worden uitgevoerd in overeenstemming met de geldende plaatselijke bouw- en installatievoorschriften. Neem contact op met een specialist als u vragen hebt.

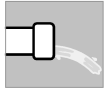

Laat vóór de installatie water door de leiding stromen om eventuele bezinkzels te verwijderen. Schade aan het product kan zo worden vermeden.

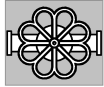

Draai de hoofdkraan van de watertoevoer dicht voordat u de kraan vervangt.



"VOORZICHTIG!

Draai schroefverbindingen ook met geplaatste pakking niet te vast aan om beschadigingen te voorkomen."

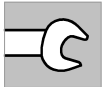

Controleer regelmatig of de installatie niet lekt.

S

Installationen måste genomföras i enlighet med de lokala bygg- och installationsföreskrifterna. Kontakta en specialist om du har frågor.



Innan installationen bör man spola vatten genom ledningen för att avlägsna eventuella rester. På så sätt kan man förhindra skador på produkten.

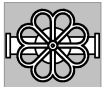

Stäng vattentillförselns huvudkran innan du byter ut blandaren.



"OBS!

Dra inte åt skruvanslutningar med ilagd tätning för hårt, för att förhindra skador."

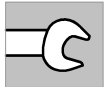

Kontrollera regelbundet att installationen är tät.

DK

Installationen skal udføres i henhold til de lokalt gældende bygge- og installationsforskrifter. Hvis du er i tvivl eller har spørgsmål, bedes du rådføre dig med en fagmand.



Lad vandet løbe gennem rørledningen inden installation, så eventuelle rester fjernes. På den måde kan det undgås at beskadige produktet.

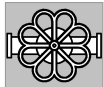

Luk for hovedhanen, inden armaturet skiftes ud.



"FORSIGTIG!

For at undgå beskadigelse bør skrueforbindelserne ikke strammes for meget, heller ikke når pakningen er sat i."

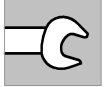

Kontroller regelmæssigt, at installationen er tæt.

N

Installasjonen må gjennomføres i samsvar med gjeldende bygge- og installasjonsforskrifter. Ta kontakt med en fagperson hvis du har spørsmål.

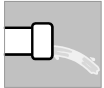

Før installasjonen bør man la det renne vann gjennom ledningen for å fjerne eventuelle rester. Slik kan man unngå skade på produktet.

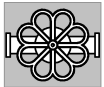

Skru av hovedkranen til vanntilførselen før utskiftingen.



"FORSIKTIG!

Ikke trekk til skruforbindinger med innlagt tetning for mye, så unngår du skader."

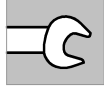

Kontroller regelmessig at installasjonen er tett.

FIN

Asennus on suoritettava voimassa olevien paikallisten rakennus- ja asennusmääräysten mukaisesti. Jos ilmenee kysyttävää, ota yhteyttä ammattilaiseen.

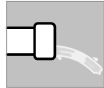

Ennen asennusta putken läpi tulisi laskea vettä, jotta mahdolliset jäämät poistuvat. Siten voidaan välttää tuotteen vaurioituminen.

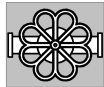

Kierrä vedensyötön päähana irti ennen hanan vaihtamista.



"VAROITUS!

Älä kiristä ruuviliitoksia liian tiukkaan silloinkaan, kun tiiviste on paikallaan, jotta vaurioita ei synny."

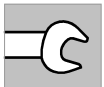

Tarkista säännöllisesti, että asennus on tiivis.

PL

Instalację należy przeprowadzić odpowiednio do lokalnie obowiązujących przepisów budowlanych i instalacyjnych. W razie pytań skontaktować się z fachowcem.



Przed instalacją należy przepuścić przez rurę wodę, aby usunąć wszelkie pozostałości. W ten sposób można uniknąć uszkodzenia produktu.

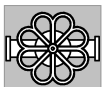

Kran główny z doprowadzeniem wody zakręcić przed wymianą armatury.

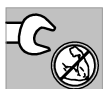

"OSTRZEŻENIE!

Nie dokręcać zbyt mocno połączeń śrubowych, nawet z założoną uszczelką, aby uniknąć uszkodzeń."

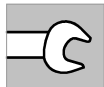

Regularnie kontrolować, czy instalacja jest szczelna.

GR

Η τοποθέτηση θα πρέπει να πραγματοποιείται σύμφωνα με τους ισχύοντες τοπικούς κανονισμούς κτιρίων και εγκατάστασης. Για τυχόν απορίες, επικοινωνήστε με κάποιον ειδικό.

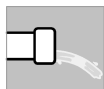

Πριν από την τοποθέτηση, πρέπει να διοχετεύσετε νερό μέσω του σωλήνα για να αφαιρεθούν τυχόν υπολείμματα. Μπορείτε κατά αυτόν τον τρόπο να αποφύγετε τυχόν ζημιές στο προϊόν.

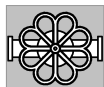

Κλείστε την βρύση κύριας παροχής νερού πριν αντικαταστήσετε το εξάρτημα.



"ΠΡΟΣΟΧΗ!

Μην σφίγγετε υπερβολικά τις βιδωτές συνδέσεις, ακόμη και με την τσιμούχα τοποθετημένη, ώστε να αποφύγετε τυχόν



Ελέγχετε τακτικά ότι η εγκατάσταση είναι σφικτή.

CZ

Instalace musí být provedena v souladu s platnými místními stavebními a montážními předpisy. V případě dotazů se obraťte na odborníka.



Před montáží je třeba nechat protéct vodu přes potrubí, aby se odstranily případné usazeniny. Zabráňte tak poškození výrobku.

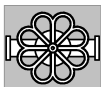

Před výměnou armatury zavřete hlavní kohoutek přívodu vody.



"UPOZORNĚNÍ!

Šroubové spoje příliš neutahujte, a to ani s nasazeným těsněním, aby nedošlo k jejich poškození."

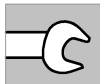

Těsnost montáže pravidelně kontrolujte.

H

A szerelést a helyileg érvényben lévő építési és szerelési előírások szerint kell elvégezni. Kérdés esetén, kérjük, forduljon szakemberhez.

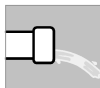

Szerelés előtt folyasson át vizet a vezetéken, nehogy szennyeződés maradjon a csőben. Ezzel elkerülhető a termék károsodása.

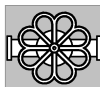

A szerelvény lecserélése előtt zárja el a bejövő vízág főcsapját.



"VIGYÁZAT!

A károsodás elkerülése érdekében a tömítés behelyezése után se húzza túl szorosra a csavarkötéseket."

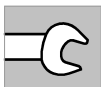

Rendszeresen ellenőrizze a szerelvény tömítettségét.

P

A instalação deve ser realizada de acordo com os regulamentos locais de construção e instalação em vigor. Se tiver alguma dúvida, entre em contacto com um canalizador.



Antes da instalação, deve deixar correr água pelo cano para remover quaisquer resíduos. Deste modo podem ser evitados danos no produto.

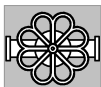

Feche a torneira principal de abastecimento de água antes de substituir a torneira.



"CUIDADO!

Não aperte demais as uniões roscadas, mesmo com a vedação inserida, de forma a evitar danos."

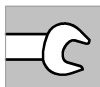

Verifique regularmente se a instalação está correta.

TR

Montaj, geçerli yerel inşaat ve sıhhi tesisat yönetmeliklerine uygun olarak gerçekleştirilmelidir. Emin değilseniz lütfen bir uzmana başvurun.

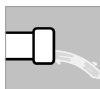

Herhangi bir artığı gidermek için montajdan önce su borudan durulanmalıdır. Böylece üründe hasar oluşması önlenir.

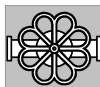

Bataryayı değiştirmeden önce ana su girişini kapatın.



"DİKKAT!

Vida bağlantıları conta takılı olsa bile deformasyona neden olmamak için fazla sıkmayın."



Montajın sızdırmadığından emin olmak için düzenli aralıklarla kontrol edin.

SK

Inštalácia sa musí vykonať v súlade s platnými miestnymi stavebnými predpismi a predpismi pre vodoinštalácie. V prípade otázok sa obráťte na odborníka.

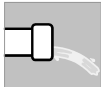

Pred inštaláciou by sa malo potrubie prepláchnuť vodou, aby sa odstránili všetky zvyšky. Tým sa dá predísť poškodeniu výrobku.

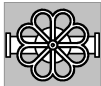

Pred výmenou armatúry vypnite hlavný prívod vody.



"UPOZORNENIE!

Aby nedošlo k poškodeniam, skrutkové spoje neutahujte príliš silno, a to ani pri vloženom tesnení."

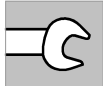

Pravidelne kontrolujte, či inštalácia dobre tesní.

SLO

Inštalacijo morate izvesti ustrezno z veljavnimi krajevnimi gradbenimi in inštalacijskimi predpisi. Pri vprašanjih se obrnite na strokovnjaka.

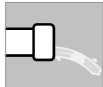

Pred inštalacijo pustite teči vodo skozi napeljavo, s čimer odstranite morebitne ostanke. Tako lahko preprečite poškodbo proizvoda.

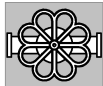

Pred menjavanjem armature zaprite glavni ventil za dovajanje vode.



"PREVIDNO!

Vijačnih povezav tudi z vložnim tesnilom ne privijte premočno, s čimer preprečite poškodbe."

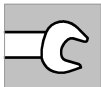

Redno preverjajte, da inštalacija tesni.

HR

Ugradnja se mora izvesti u skladu s važećim lokalnim propisima o gradnji i ugradnji. Ako imate pitanja molimo obratite se stručnjaku.

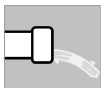

Prije ugradnje treba pustiti vodu da prođe kroz cijev kako bi se uklonili eventualni ostaci. Na taj način se možete izbjeći oštećenje proizvoda.

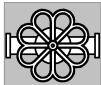

Prije zamjene armature zatvorite glavni ventil za dovod vode.



"OPREZ!

Čak i s umetnutim brtvilom suviše ne zatežite vijčane spojeve, kako biste izbjegli oštećenja."

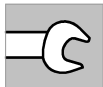

Redovito provjeravajte je li instalacija dobro zabrtvljena odnosno nepropusna.

BG

Монтажът трябва да се извърши според приложените местни строителни и монтажни разпоредби. При въпроси се допитайте до специалист.

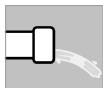

Преди монтаж трябва да се остави да тече вода от тръбопровода, за да се отстранят евентуални остатъци. Така може да бъде избегната повреда на продукта.

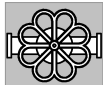

Развийте основния кран за пускане на водата преди смяната на батерията.



"ВНИМАНИЕ!

За да избегнете повреди, не затягйте винтовите съединения, дори и с поставен уплътнител."



Редовно контролирайте монтажа за течове.

EST

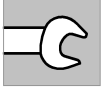

Paigaldage kohalike ehitus- ja paigaldusnõuete kohaselt. Küsimate korral pöörduge spetsialisti poole.

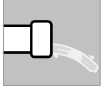

Enne paigaldamist laske veel läbi paigaldise joosta, et võimalikud jäägid eemaldada. Nii saab vältida toote kahjustumist.

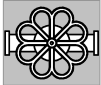

Keerake vee juurdevoolu peakraan enne armatuuri vahetamist lahti.



"ETTEVAATUST!

Kahjustuste vältimiseks ärge keerake keermesühendusi koos tihendiga liiga tugevasti kinni."



Kontrollige regulaarselt paigalduse lekkekindlust.

LV

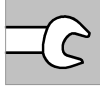

Uzstādīšana jāveic saskaņā ar spēkā esošajiem vietējiem būvniecības un uzstādīšanas noteikumiem. Ja jums ir kādi jautājumi, lūdzu, sazinieties ar speciālistu.

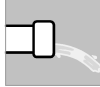

Pirms uzstādīšanas caur cauruli jāplūst ūdenim, lai noņemtu iespējamus atlikumus. Tādējādi var izvairīties no izstrādājuma bojājumiem.

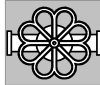

Pirms armatūras nomaiņas aizveriet galveno ūdens pievadīšanas krānu.



"UZMANĪBU!

Lai izvairītos no bojājumiem, nepievelciet skrūsvienojumus pārāk cieši pat tad, ja ir ievietots blīvējums."



Regulāri pārbaudiet uzstādīšanas blīvumu.

LT

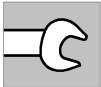

Įrengimas turi būti atliekamas laikantis galiojančių vietinių statybos ir įrengimo taisyklių. Jei turite klausimų, kreipkitės į specialistą.



Prieš įrengiant vandentiekio liniją, per ją reikia perleisti vandenį, kad būtų pašalinti galimi likučiai. Taip galima išvengti gaminio pažeidimo.

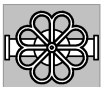

Prieš keisdami jungtį užsukite pagrindinį vandens tiekimo maišytuvą.



"DĖMESIO!

Neužveržkite varžtinių jungčių pernelyg stipriai, net ir esant uždėtam sandarikliui, kad jų nepažeistumėte."



Reguliariai patikrinkite, ar įrenginys yra sandarus.

RO

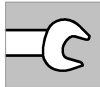

Instalarea trebuie efectuată conform reglementărilor locale de construcție și de instalare în vigoare. Dacă aveți întrebări, adresați-vă unui specialist.

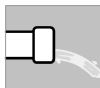

Înainte de instalare, trebuie să lăsați să curgă apa prin conductă, pentru a îndepărta eventualele reziduuri. Astfel se poate evita o posibilă deteriorare a produsului.

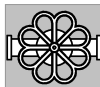

Desfaceți prin rotire robinetul principal al alimentării cu apă înainte de schimbarea bateriei.



"ATENȚIE!

Nu strângeți prea tare racordurile filetate, chiar și cu garnitura aplicată, pentru a evita deteriorările."



Controlați regulat dacă instalația este etanșă.

UA

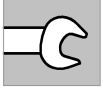

Встановлення слід виконувати відповідно до застосованих місцевих будівельних і монтажних норм. У разі виникнення питань, будь ласка, зверніться до спеціаліста.

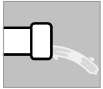

Перед встановленням промийте трубопровід, щоб усунути можливий осад. Це дозволить уникнути пошкодження виробу.

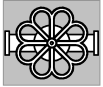

Перед заміною змішувача перекрийте магістральний кран водопровідної мережі.



"УВАГА!
Не затягуйте гвинтові з'єднання з ущільненнями до відмови, щоб уникнути пошкоджень."



Регулярно перевіряйте герметичність установки.

UAE

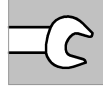

يجب إجراء التركيب وفقاً لوائح البناء والسباكة المحلية المعمول بها. إذا كان لديك أي شك، فاتصل بخبير.

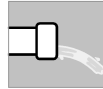

قبل التركيب، يجب تمرير مياه بداخل الأنابيب لإزالة أي بقايا. يمكن تجنب حدوث تلف في المنتج.

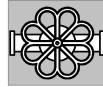

قبل تغيير التركيب، أوقف تشغيل صمام الإغلاق الرئيسي.



إتحذير!
لا تفرط في إحكام وصلات المسامير اللولبية، حتى مع إدخال العازل، لتجنب التلف."



تحقق على فترات زمنية منتظمة للتأكد من أن التركيب لا يسرب.

CN

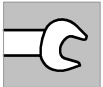

必须遵守当地适用的建筑和水暖法规进行安装。如有疑问，请联系专家。

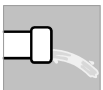

安装前，应用水冲洗管道，以清除任何残留物。可避免对产品的损害。

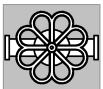

更换配件前，请先关闭总截止阀。



"警告！
即便已装入密封圈，也请勿过度拧紧螺丝连接，以避免造成损坏。"



定期检查，确保安装没有出现渗漏。

RUS

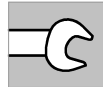

Установку следует выполнять в соответствии с действующими местными строительными и монтажными нормами. В случае возникновения вопросов, пожалуйста, обратитесь к специалисту.

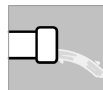

Перед установкой промойте трубопровод, чтобы устранить возможные отложения. Это позволит избежать повреждения продукта.

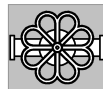

Перед заменой смесителя перекройте магистральный кран водопроводной сети.



"ОСТОРОЖНО!
Не затягивайте резьбовые соединения с уплотнениями до отказа, чтобы избежать повреждений."



Регулярно проверяйте герметичность установки.

