

CHATSWORTH

Luxury Rigid Riser Kit with Diverter

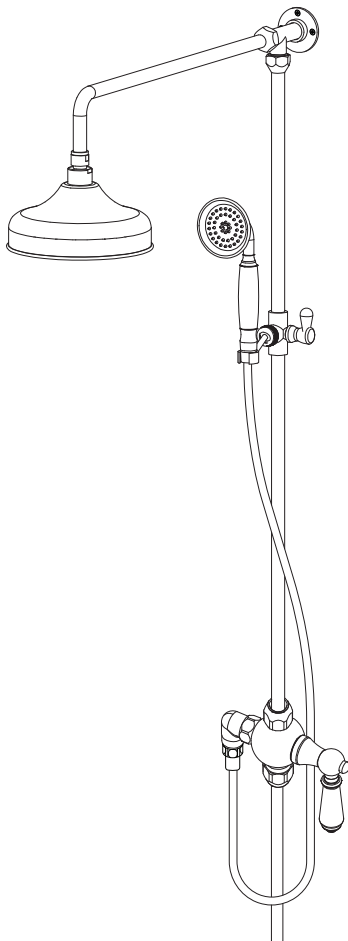

Fitting Instructions

Please follow them carefully and
leave this manual with end user

Installation Guide

Before you begin:

1. **We recommend that this product is installed by a qualified tradesperson.** Victorian Plumbing Ltd. accept no liability for products incorrectly installed, or where the correct testing procedures have not been adhered to, thus resulting in the escape of water and consequential damage.
2. Ensure the incoming mains water supply is switched off prior to commencing the installation.
3. Observe all local plumbing and building codes & regulations.
4. **Check the chosen wall space for any pipes/cables prior to drilling.**
5. Unpack the product then read these instructions before proceeding. Inspect the product for damage. If any damage is found, contact our Customer Relations team.

Tool required for installation (Not Included):



Power Drill



Spirit Level



Wrench



Screwdriver



Pencil

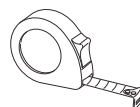

Tape

Ensure the appropriate PPE is used during installation

Fitting List:

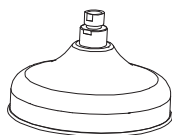

Shower Head (x1)



Shower Handset (x1)

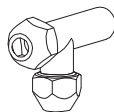

Shower Bracket (x1)

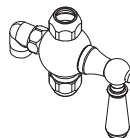

Diverter (x1)



Handset Holder (x1)



Fixing Plate (x1)



Rawl Plug (x3)



Screw (x3)

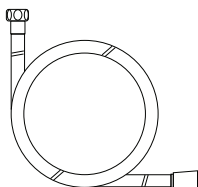

Hose (x1)



Grub Screw (x1)

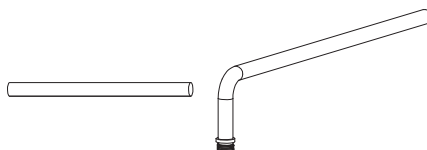

Slider Rail (x1)

Diagrams are for illustration purposes only. Your Riser Kit may superficially differ from this drawing however the installation guide steps still apply.

When installing the Shower Unit please ensure that there is a minimum of 118cm height clearance above your chosen shower valve to allow for the riser pipe and overhead shower head to be fitted.

Step 1:

- Confirm the position of the 'Fixing Plate' mark the fixing points to the wall ready for drilling. Ensure the markings are level.

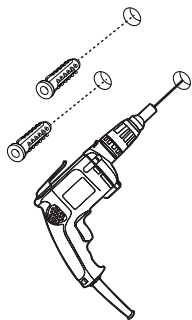
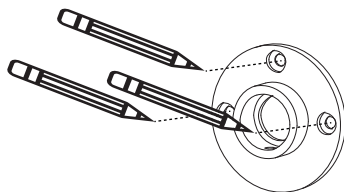

Step 2:

- Place the 'Fixing Plate' to one side. Using an appropriate sized drill bit, carefully drill the holes in the wall. Ensure that there are no hidden pipes/cables behind the wall markings. Insert the 'Rawl Plugs' provided into the drilled holes.

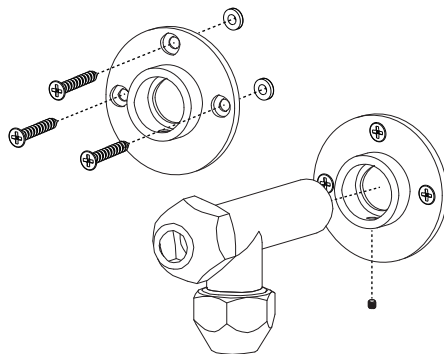

Step 3:

- Place the 'Fixing Plate' over the 'Rawl Plugs'. Using the 'Screws' provided, fix the plate to the wall by screwing into the 'Rawl Plugs'. Attach the 'Shower Bracket' to the 'Fixing Plate' using the 'Grub Screw' provided.

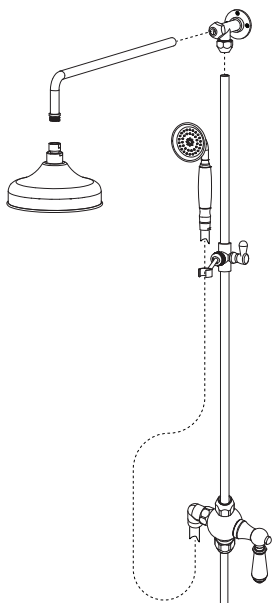

Step 4:

- Attach the 'Slider Rails' to the 'Diveter' and 'Shower Bracket'. Install the 'Shower Head' and 'Handset'.
- Connect the 'Riser Kit' to your chosen 'Shower Valve'. Turn on the water supply, check all joints and connections for any leaks.

Aftercare:

Always clean the surface of shower to keep it bright. **Attention:** please do not use inappropriate tools such as sharp brushes, rough sponges, scouring pads or corrosive detergent to clean the shower. Please clean the shower by wet cloth and soapy water after each time of usage. Then rinse the soap out with clean water and dry with a soft cotton cloth.

Recycling and Disposal:

Please recycle the packaging in accordance with your local government regulations on waste handling and follow the same advice at the end of the products life.

www.victorianplumbing.co.uk