

INSTALLATION INSTRUCTIONS FOR SWIVEL FRAME MIRRORS

Before installing this product pay special attention to these instructions.

Installation Tools

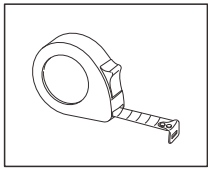

Measuring tape

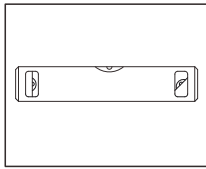

Spirit level

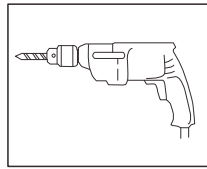

Drill

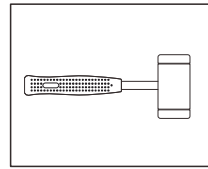

Hammer

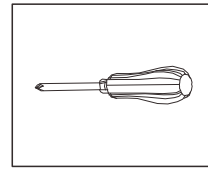

Screwdriver

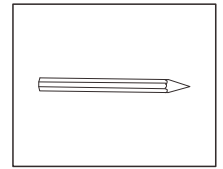

Pencil

Installation Steps

1. Put a pencil through the screw holes of the base fixing disc to mark the two points A and B on the wall and punch the holes. Screw the M4*50 self-tapping screw through the base fixing disc and into the wall.
2. Screw the M8*30 top wire into the base fixing disc.
3. Insert base into top wire.
4. Screw the base connecting rod into the top wire.
5. Screw the reducing screw into the base connecting rod.
6. Screw the through ball into the reducing screw.
7. Put on 40 washers.
8. Put on the crown shims.
9. Screw the ball head rod through the 40 washer, through hole ball and crown gasket into the rivet nut of the frame.
10. Do the same on the other end of the frame.

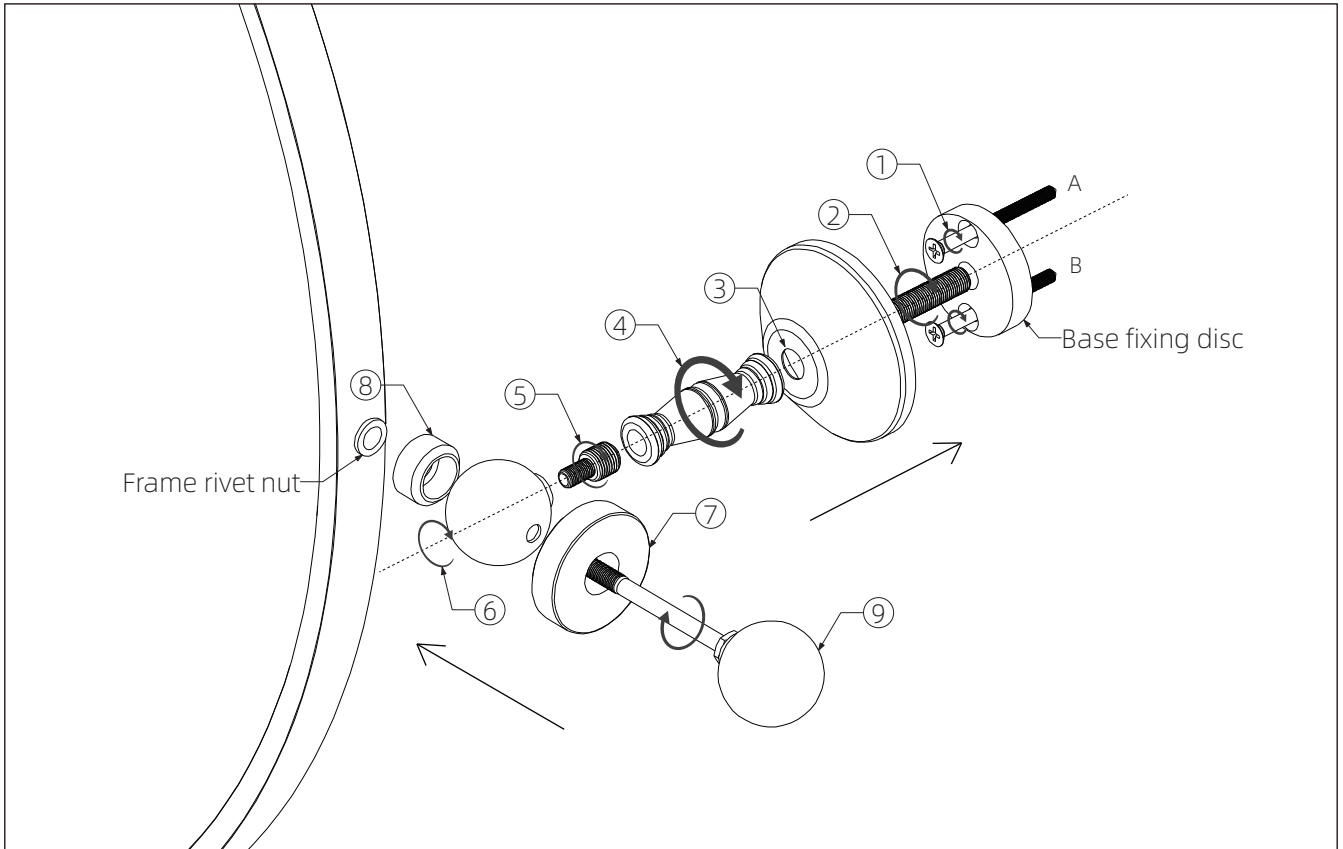

Never modify the construction or add any parts which are not offered as spare parts or accessories by the manufacturer of the luminaire. Any unauthorized modification might result in weak mounting and risk that parts of the luminaire can fall down from the wall.

Recycling and disposal

Please recycle the packaging in accordance with your local government regulations on waste handling, and follow the same advice at the end of the products life.

For more Information

Visit: victorianplumbing.co.uk