





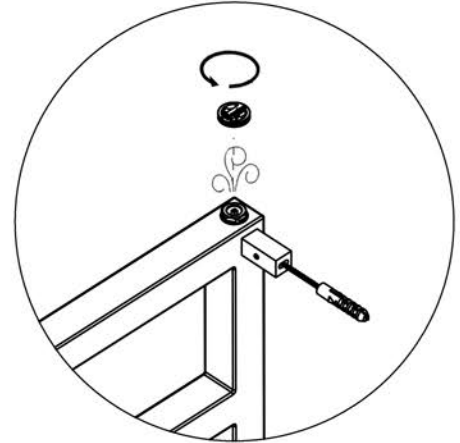

Key	Component	Qty
	A Bleeding Valve Key	1
	B Bleeding Valve 1/2"	1
	C Stud	4
	D Square Wall	4
	E Grub Screw	4
	F Screw-5,5x45mm	4
	G Wall Plug	4



Assembly Instructions

- Use Carisa bleeding valve key (A) to turn bleeding valve on final installation (B).
- Accurately mark out bracket holes on wall using spirit level.
- Drill four 8mm hole for each brackets (D).
- Screw brackets (D) into wall plugs (G) with 5,5mm diameter x 45mm screws (F).
- Assemble the studs (C) into the holes which on back of the collector.
- Hang radiator by centering the studs (C) into the brackets (D).
- Secure the stud (C) with the grub screw (E) after setting wall distance.