

Installation, Operation & Maintenance Manual – NOVA PRO + Biocera A-A



BMB

WATER FILTRATION

NOVA PRO SIZES



www.bmbwaterfiltration.co.uk

© Copyright Protected

Index-

- Page 1 - 2, Introduction to Nova Pro**
- Page 3 – 10, Nova Pro water purification technology and stages explained.**
- Page 11 – 15, Nova Pro Technical information and component locations.**
- Page 16, Tools required for installation**
- Page 17- 18, Nova Pro basic set up diagrams**
- Page 19 – 20, Use of push fits**
- Page 21, Installation components**
- Page 22 - 23, Installation steps**
- Page 24 – 26, RO Membrane installation**
- Page 27,..... Tank Installation**
- Page 28 -29, Start up and commissioning**
- Page 30 - 31, Digital interface instructions**
- Page 31, Maintenance**
- Page 33, Going on holiday**
- Page 34, Trouble shooting table**
- Page 35 – 36, Pre & post filter change**
- Page 37, Service/filter change log**
- Page 38, Warranty registration**
- Page 39, Limited warranty**

Introduction

The purpose of the Installation, Operation & Maintenance Manual is to give users a reference for Technical Specifications, Connection Diagrams, Installation Procedures, System Operation and System Maintenance of their **BMB Technology** Reverse Osmosis System.

The essential information contained in this manual will allow the user to make full use of the system. In the interest of brevity, an attempt has been made to include only that information which will be used under normal operating circumstances. For special situations, it is recommended that the user contact their authorized dealer or **BMB Technology** (www.bmbtechnology.com).

Reverse Osmosis is the most advanced technology of water purification in use today. The technique uses a nanotechnology enabled semipermeable membrane which can reduce or remove most harmful impurities found in water including: microorganisms, nitrates, heavy metals, insecticides and much more (see Figure 1 on page 3 for a comparison of different filtration technologies).

Fig 2, on page 3 lists a more detailed filtration performance of specific materials. These materials are only a partial list of the virtually hundreds of thousands of molecules that Reverse Osmosis can filter out.

Osmosis is defined as the process of molecules passing through a semipermeable membrane, from a less-concentrated solution to a more-concentrated solution. An example of Osmosis is the roots of plants drawing water from the soil. Reverse osmosis is simply the opposite of this process where molecules are forced through a semipermeable membrane to form a less-concentrated solution.

Essentially, the Reverse Osmosis filter (RO membrane or RO element) has nano sized pores that help remove microscopic contaminants from the incoming water (more-concentrated solution) to produce better quality water (less-concentrated solution). An illustration of this process can be found page 4, Figure 3.

There is a bit more to the Reverse Osmosis process as it pertains to Reverse Osmosis systems, however, this will be explained in more detail in the upcoming sections.

This **BMB Technology** system harnesses the power of Reverse Osmosis to purify the incoming water. It was specifically designed to enhance the Reverse Osmosis process by using sensors, pumps, probes, minerals, software and other components. This system will be mainly used in residential and commercial applications to reliably produce high quality water.

This **BMB Technology** Reverse Osmosis system is one of the most technologically advanced water filtration systems in the world. It incorporates state of the art filters, easy Plug & Play components and Quick-Change Filter Technology (QCFT) for low maintenance cost.

The system also comes equipped with a digital controller with Smart Water capabilities. It continuously analyzes the purified water and displays the results on screen. The system will know when water is consumed and will automatically flush the reverse osmosis filters afterwards to maintain water quality and extend filter lifetime. The system works in the background to track water temperature, errors and filter lifetime in order to give the highest up time possible while delivering the best water quality and user experience.

Some of the significant features of this product line are as follows:

- *Elegant & compact design / LED light-up during operation*
- *Standing bracket, no mounting required, easy installation*
- *Locking quick change pre-filters for low maintenance cost*
- *Nano zinc powder activated pre-filters for antibacterial performance*
- *BIOCERA A-A Antioxidant, Alkaline, ORP, re-mineralizing Filter*
- *High Capacity 600 GPD configuration*
- *Direct flow (no tank required) option for maximum freshness*
- *Smart capabilities optimize system performance and water quality*
- *Set and track filter lifetime to maximize cost savings*
- *Instantaneous analysis of water (TDS)*
- *Automatic flush of membranes for water quality and max. filter lifetime*
- *Quick Connect parts for easy service and maintenance*
- *Dual manometers to track incoming and pump water pressure*
- *1-2 LPM flow rate- 2.5 bar incoming pressure*
- *Tank installation option available for low pressure or High demand situations*

Fig1,
Water Filtration Technology's spectrum

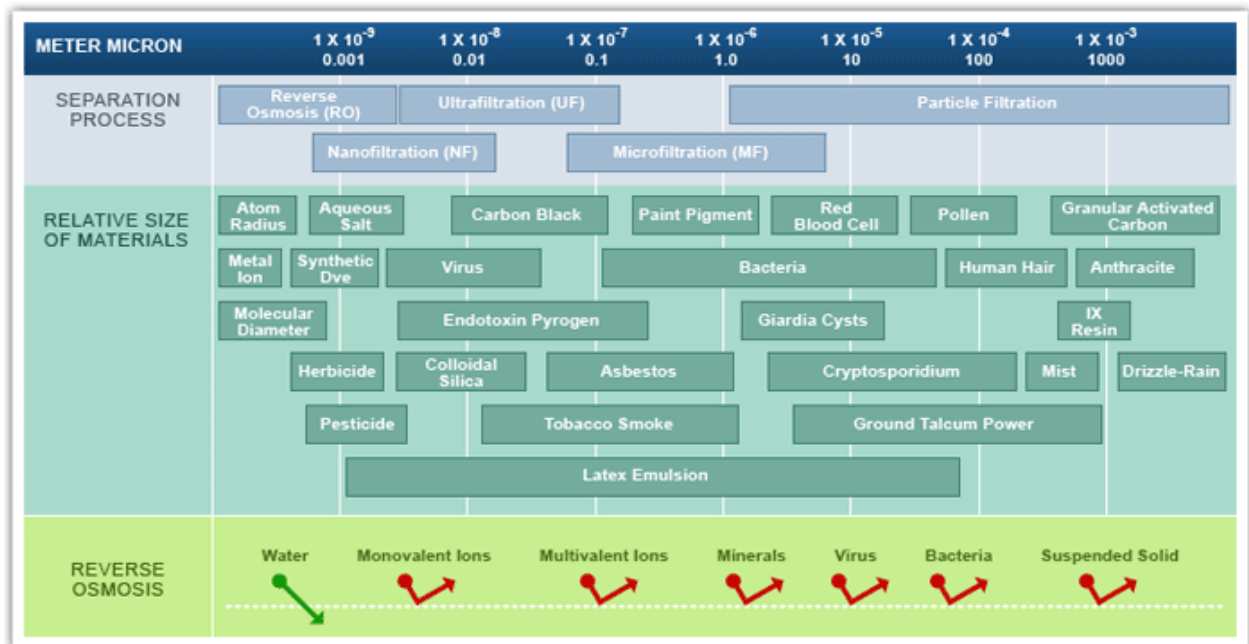
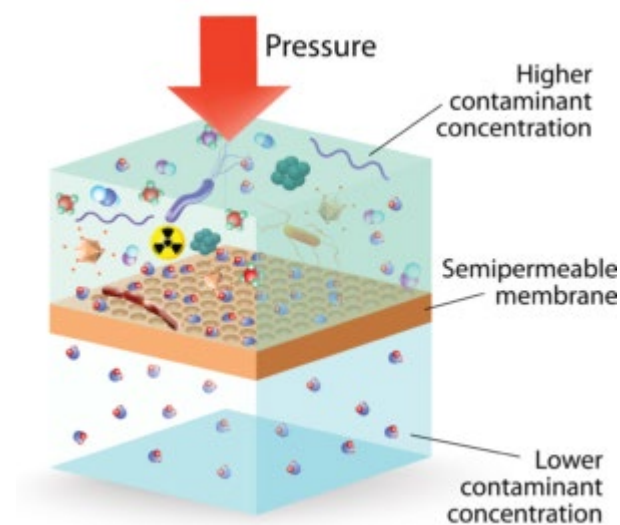

Fig 2,
 Estimated Reverse Osmosis Rejection Percentages
 * Figures given above are estimates of normal **BMB Technology** reverse osmosis membrane filter performance, under normal conditions and water quality.

Aluminum	97-98%	Nickel	97-99%
Ammonium	85-95%	Nitrate	93-96%
Arsenic	94-96%	Phosphate	99+%
Bacteria	99+%	Polyphosphate	98-99%
Bicarbonate	95-96%	Potassium	92%
Boron	50-70%	Pyrogen	99+%
Bromide	93-96%	Radioactivity	95-98%
Cadmium	96-98%	Radium	97%
Calcium	96-98%	Selenium	97%
Chloride	94-95%	Silica	85-90%
Chromate	90-98%	Silicate	95-97%
Chromium	96-98%	Silver	95-97%
Copper	97-99%	Sodium	92-98%
Cyanide	90-95%	Sulphate	99+%
Ferrocyanide	98-99%	Sulphite	96-98%
Fluoride	94-96%	Zinc	98-99%
Iron	98-99%		
Lead	96-98%	Insecticides	97%
Magnesium	96-98%	Detergents	97%
Manganese	96-98%	Herbicides	97%
Mercury	96-98%	Virus	99+%
TDS (Total Dissolved Solids)	95-99%	Hardness	93-97%

Fig 3,

Reverse Osmosis Membrane –



Nova Pro + Biocera A-A Filtration process,

The most essential part of any Reverse Osmosis system is its filters. It is also a misconception that all filters remove materials from the incoming water, some filters actually add materials into water to improve the taste, increase the mineral content and other health benefits. Although a Reverse Osmosis system can consist of many filters, they all fall into one of three categories with each category having a very specific purpose:

- *Pre-Filters*
- *Reverse Osmosis Membrane*
- *Post-Filters BIOCERA A-A - Antioxidant, Alkaline*

Pre-filtration before Reverse osmosis

The main purpose of the pre-filters is to protect the more expensive Reverse Osmosis membrane filter from specific contaminants.

Traditional Reverse Osmosis systems have pre-filters which target sediment and chlorine as they can damage the reverse osmosis filter and cause it to fail early. Additionally, traditional systems have a significant health risk where although the filters are changed periodically, the outside casing (housing) for these filters stay the same usually throughout the lifetime of the system. This can result in unhygienic conditions as contaminants will accumulate on the inside surface of the housing over time and can be gradually released into the incoming water.

This **BMB Nova Pro** Reverse Osmosis System has three state-of-the-art pre-filters. The filter element and housing are a single unit. Consequently, during filter replacement periods they are changed at the same time in order to maintain system hygiene. Also, all of the pre filters are easy to change and have a click-and-lock mechanism in order to reduce the risk of leaks. Once the filter is being changed, simply keep twisting it into place slowly until a click is heard. To remove the filter, turn and hold the lock to open position with one hand while twisting the filter with the other hand until it is removed from the system.

Although the RO membrane filters used in this system are fully efficient in removing microorganisms, the first and last pre-filters are equipped with Nano Zinc powder for antibacterial effects. This prevents biofilm buildup on the membrane sheet surface which can lead to fouling of the membrane filter. In addition to particles and chlorine, the pre-filters in this system are designed to reduce heavy metals (iron, manganese and other rust), dust and very fine particles down to 0.5 microns. This will allow the membrane filters to work with less effort to produce high quality water. Please see the table below for a detailed list of the pre-filters.

Position	Filter	Type	Filtration
1	5 Micron Antibacterial Sediment	Meltblown	Microorganisms, particles
2	NANO -CTO Block Coconut Shell Carbon	CTO Block	Chlorine, Chloramines and other organic compounds
3	0.5 Micron Antibacterial Nano Carbon	Meltblown + GAC	All of the above + fine particles, heavy metals such as iron, manganese and other rust

Pre-filters

Filter 1

Antibacterial 5 Micron Sediment

The two-stage filter is made from nano zinc powder infused, NSF certified polypropylene fibers. The fibers have a +97% efficiency of filtering particles that are 5 microns or larger while the nano zinc powder acts as an antibacterial agent for any microorganisms in the incoming water supply. Although zinc is an element that humans cannot live without, it is lethal to microorganisms such as bacteria, virus, algae, fungi, etc.

Contaminants Reduced or Removed:

Sediment, particles, dust, rust, iron, manganese, microorganisms (bacteria, algae, fungi, etc.)

Filter 2

Chlorine Taste Odour (CTO) Block, Nano Anti-Scale Coconut Shell carbon

The two-stage filter is made from NSF Certified Coconut Shell Carbon which has a very high capacity to reduce taste and odor compared to charcoal filters. With a higher absorbent level.

Contaminants Reduced or Removed:

Water Hardness, Volatile organic compounds (VOCs). Chlorine, chloramine, pesticides, herbicides, nitrate, phosphate, lithium, pharmaceuticals, microplastics, arsenic, asbestos, lead, zinc, copper, mercury and other heavy metals

Filter 3

Antibacterial 0.5 Micron Nano Carbon

The two-stage filter is made from nano zinc powder infused, NSF certified polypropylene fibers. The fibers have a +97% efficiency of filtering particles that are 0.5 microns or larger while the nano zinc powder acts as an antibacterial agent for any microorganisms in the incoming water supply. Although zinc is an element that humans cannot live without, it is lethal to microorganisms such as bacteria, virus, algae, fungi, etc.

Contaminants Reduced or Removed:

Particles, dust, rust, iron, manganese, microorganisms (bacteria, algae, fungi, etc.)

Reverse osmosis Membrane- filters 4 & 5 Total - 600 GPD

At the heart of every Reverse Osmosis system is the membrane filter's. The membrane filter consists of microporous, semipermeable membrane sheets. The sheets are glued to each other around three edges with a thin spacer in between (prevents the sheets from sticking to each other) to form a "leaf". Next, depending on the desired capacity of the membrane filter, multiple leaf's with mesh spacers in between (to allow the water to pass between leaf's) are stacked on top of each other. The stack is then spirally wound with the open end of the leaf adhered to a perforated tube that runs up and down the center.

The membrane is constructed in this manner because unlike the pre-filters which are designed as "dead-end filtration", Reverse Osmosis membranes are designed as "crossflow filtration". In dead-end filtration, the feed water is passed perpendicular to the filter surface in order to trap large particles. However, in Crossflow filtration the feed water is passed tangential to the filter surface so the more-concentrated solution (particles) exits at the end of the filter while the less-concentrated solution (purified water) permeates through the membrane surface, gets trapped between the sheets and exits out of the perforated tube.

Figure 4 below shows the difference between dead-end filtration and crossflow filtration.

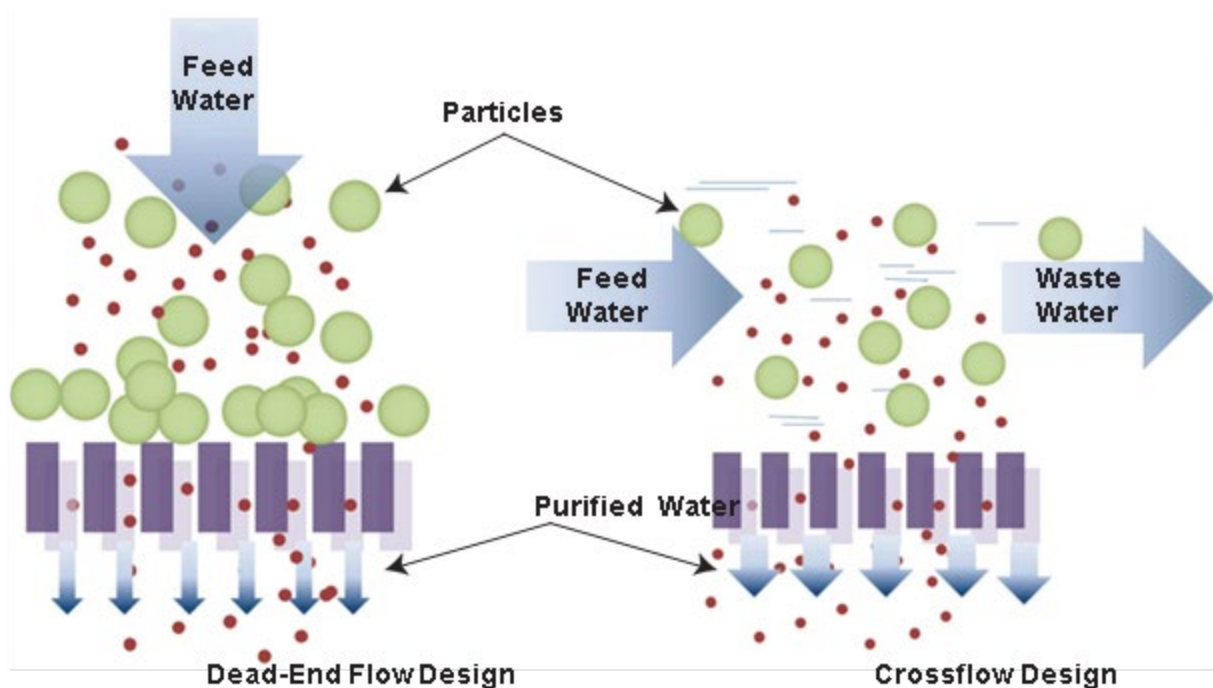

The membrane pores are so small that if the Reverse Osmosis filter was designed as dead-end, the pores would be clogged up in a matter of few liters due to the abundant number of dissolved solids found in the feed water and the extremely small membrane pore size.

The membrane filter has one water inlet and two exits. The feed water first travels through the pre-filters and then to the membrane filter. At the exit of the membrane filter one of the ports is the waste water (more-concentrated solution) which is connected to the drain, while the other port is the purified water (less-concentrated solution) which is plumbed to the post-filters. Figure 5 on page 9 shows a detailed schematic of the membrane filter.

BMB Technology Reverse Osmosis membranes are made of the highest quality Thin Film Composite (TFC) polyamide and are designed to remove a wide variety of both aesthetic and health related contaminants. Additionally, the following have been, considered when designing the membrane filter:

- *Average membrane pore size of 0.0005 μ m*
- *Ultra Low Pressure (ULP) membrane (min. 2 bar feed water pressure)*
- *Included system pump for optimum osmotic pressure*

Reverse Osmosis Membrane Filter

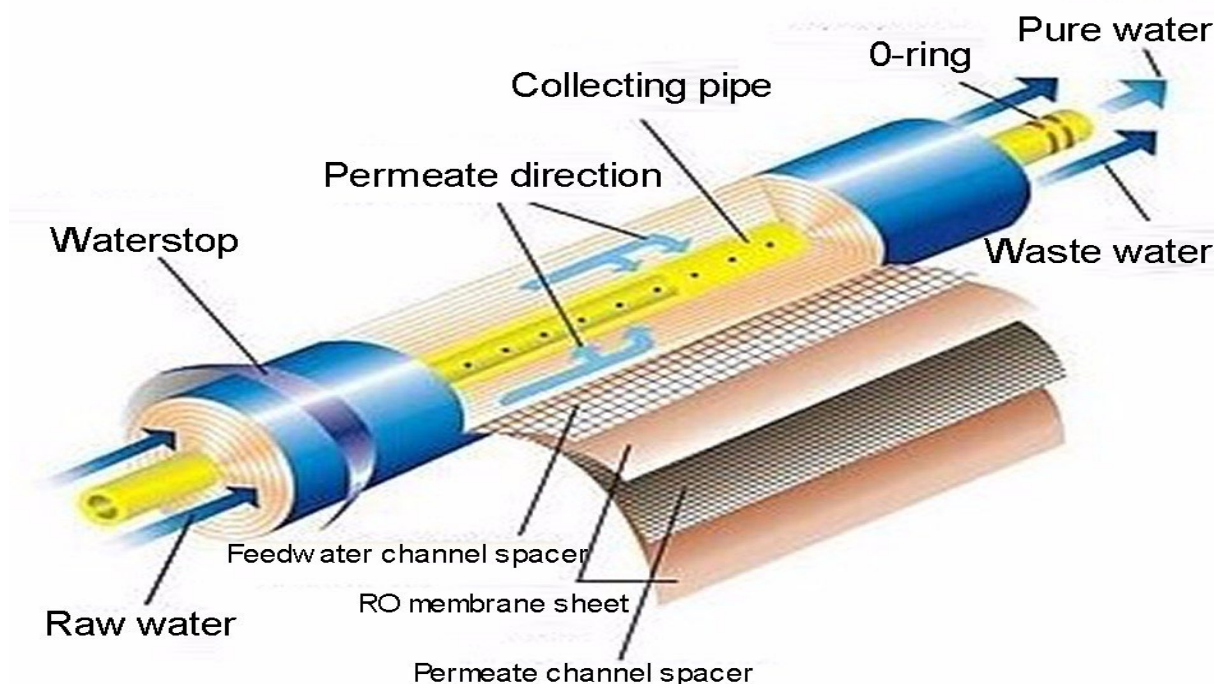

BIOCERA A.A FILTER (Antioxidant Alkaline)



BIOCERA A.A Filter 10" TCR

Biocera A.A Filter increases pH, active hydrogen (removes free radicals) and makes alkaline water. It provides negative ORP making smaller water clusters and supplies health minerals.

- ✔ Increases pH levels
- ✔ Decreases ORP values
- ✔ Guarantees clear, better-tasting water
- ✔ Excellent anti-oxidant effect such as Vitamin C
- ✔ Contains NSF-certified, patented ceramic balls
- ✔ No detection Heavy metal (Hg, Pb, As, Cr, Cd, etc)
- ✔ Makes water molecules so smaller and more easily absorbed by cells
- ✔ Supplies beneficial minerals such as calcium, magnesium, potassium, etc.
- ✔ Improves the reducing capacity of water by re-moving active oxygen/free radicals

BIOCERA A.A Filter Applications



www.biocera.co.kr
biocera@biocera.co.kr

Nova Pro Specifications

Parameter	Value
Electricity	100 - 240 VAC / 50-60 Hz
Feed Water Pressure	2.5 Bar Min. - 6 Bar Max.*
Feed Water Temperature	4 - 40 °C
Feed Water Connection	3/8"
System Dimensions (L x W x H)	42 cm x 30 cm x 49 cm
System Weight (no water)	16 KG
Tank Dimensions (L x W x H)	24 cm x 24 cm x 37 cm **

The supply water requirements for this system can be found in

Table below.

If the water supply does not meet these requirements, the filter lifetime and output water quality of the system can be affected. Please see section 7.1 for the recommended filter lifetime of this system. This duration should be reduced depending on how much the water quality exceeds the limits. Please also see section 7.2 on how to adjust the filter change duration in the user interface.

If the feed water is supplied with raw well water, laboratory test of the water should be done before installing the system. If there is a significant exceeding of these limits, a well water treatment system at the source should be considered to correct the water quality.

Parameter	Value
pH	6.5 - 8.5
Turbidity	< 5 NTU
TDS	< 500 PPM
Hardness	< 500 PPM CaCO ₃ (50 °F) (28 °dH)
Chloride	< 250 PPM
Free Chlorine	< 0.7 PPM
Iron	< 0.1 PPM
Manganese	< 0.1 PPM
Silica	< 0.1 PPM
Chemical Oxygen Demand	< 5 PPM O ₂
Total Bacteria Count	< 50 CFU / mL
E. Coli	< 3 CFU

The main components for this system can be found on the next page.

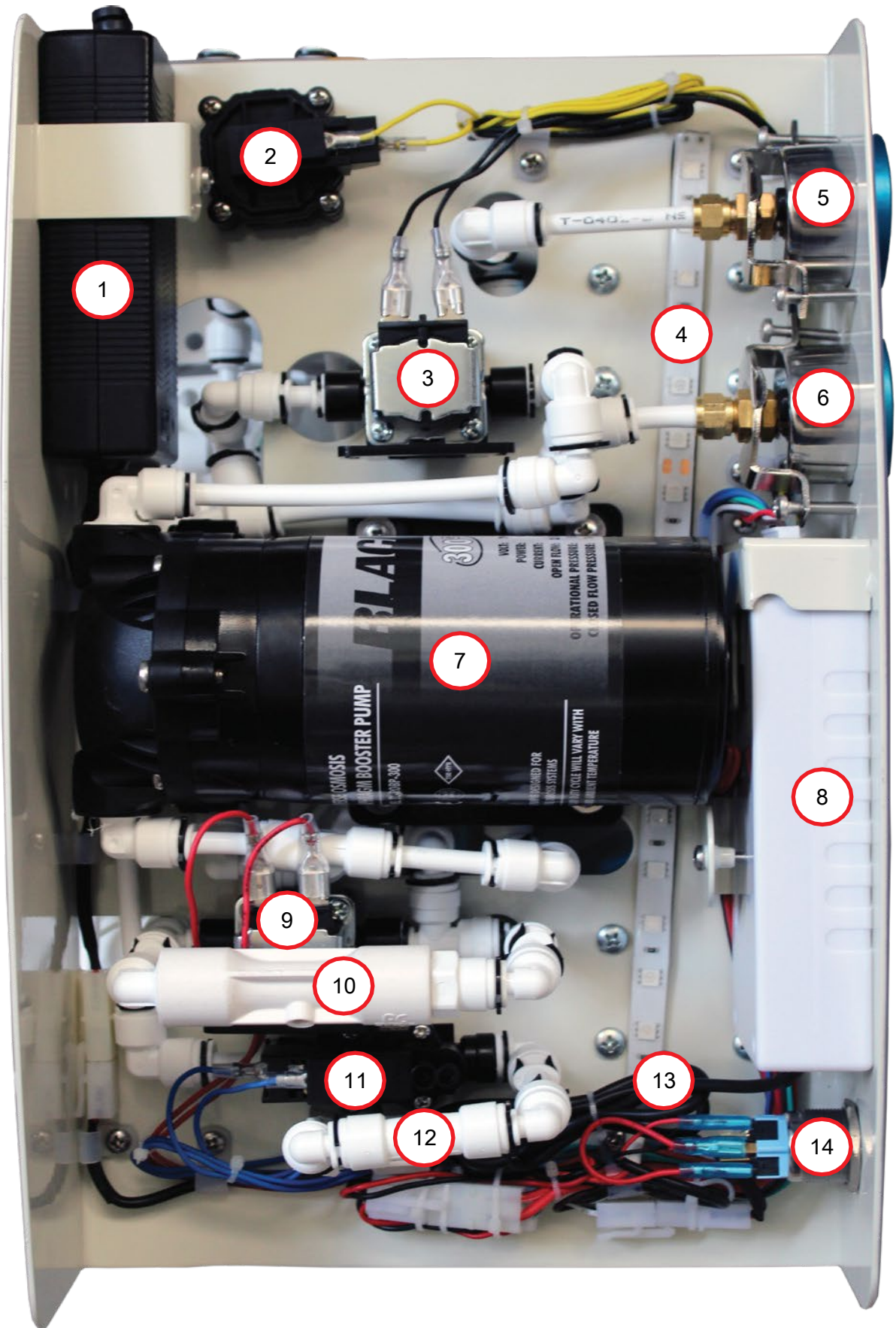

List of system components and functions

No:	Component	Function
1	Power Supply	Supplies 24V / 3.7A to the system
2	Low Pressure Switch	Prevents water production at low inlet water pressure in order to protect the system from overheating, will give a "No Water" alarm on the digital controller
3	Inlet Water Solenoid Valve	Closes feed water supply when system goes into standby or alarm mode
4	LED Strip	Acts as a visual guide, lights during water production
5	Inlet Water Pressure Manometer	Measures feed water pressure
6	Pumping Pressure Manometer	Measures pumping pressure
7	Pump	Increases feed water pressure to supply the reverse osmosis membrane filters at optimum osmotic pressure
8	Digital Controller	Controls all system components, measures TDS and regulates filter lifetime
9	Auto-Flush Solenoid Valve	Activates in between water production and standby mode to flush the reverse osmosis membrane filters for 10 seconds in order to protect them from caking
10	Flow Restrictor	Controls ratio of produced water to waste water for optimum reverse osmosis membrane filter performance
11	High Pressure Switch	Activates pump during low pressure, stops pump and sends system to standby mode during high pressure
12	Check Valve	Prevents production of waste water during standby mode
13	TDS Probe	Measures produced water TDS before remineralization
14	LED On/Off Button	Turns system on or off

System Filter locations

Pre filters

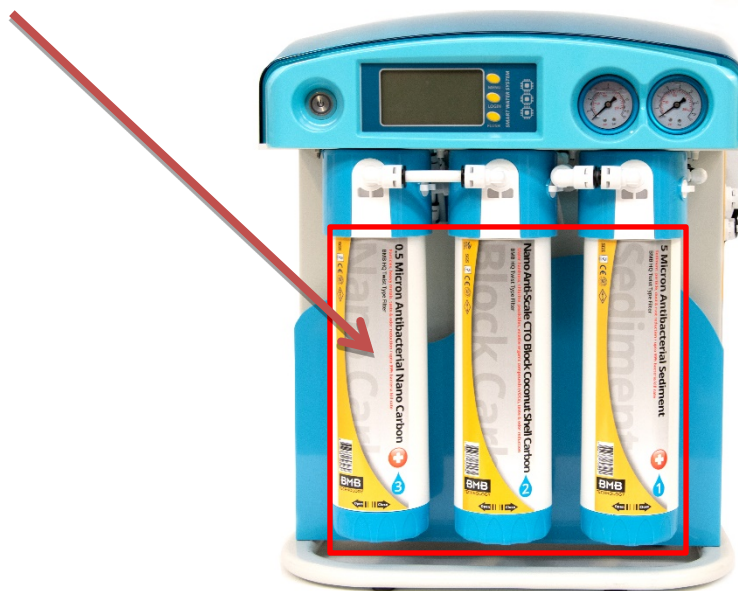



post filters

Reverse osmosis membranes

System on Board Water Ports

This system comes with four water ports on the side for easy installation and maintenance. Since the system is wet tested after assembly, it is shipped with plugs on all of the ports in order to prevent any potential leaking in the box from residue water that may be left after testing. It is important to note that if the system does not require a tank, the plug on the “Tank” connection should be left intact.

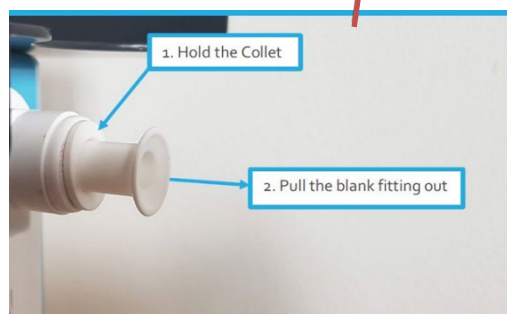
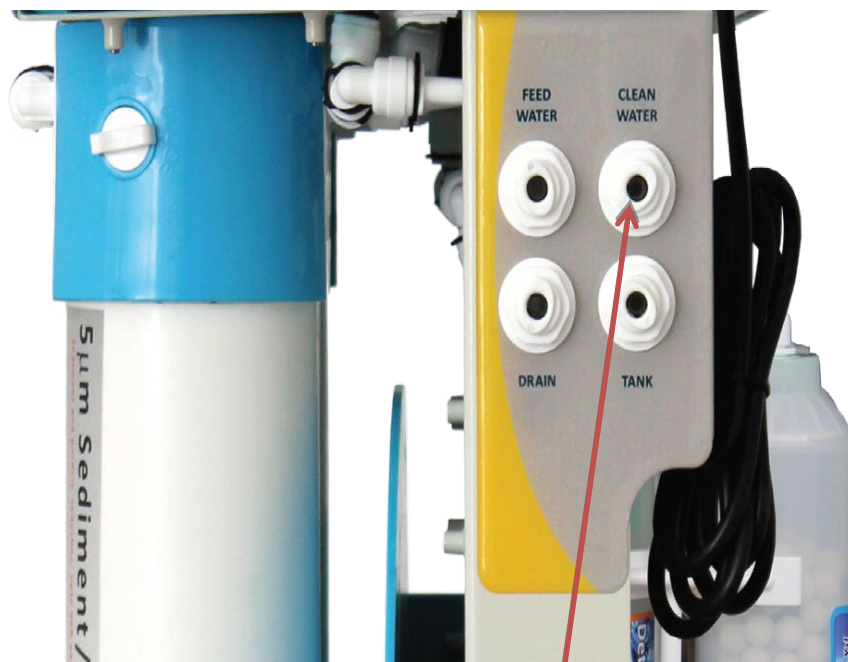

Planning the Installation

The following tools will be needed for the installation of this system. Please see Table below

Tools Required	Installation Function
Electric Drill	Open hole on sink to mount the faucet*
5 mm or 1/8" diamond tip drill bit	Pilot hole for faucet*
12 mm or 1/2" diamond tip drill bit	Main hole for faucet stem*
7 mm or ¼ tip drill bit	Tubing hole for drain saddle
Adjustable Wrench	Installing feed water diverter valve, metal ball valve and faucet
Phillips Screw Driver	Mount drain saddle
Sharp Scissors or Knife	Shorten tubing if needed

BMB Nova Pro does not ship with a tank and unless the water pressure is below 2 bar or the consumption is high (more than 300 liters / day), it will not require one.

Nova Pro connection diagram

Below a connection diagram can be found for the BMB Nova Pro Model. The BMB Nova Pro model is a system that can be used for both residential and commercial applications. The system is a direct flow model (tankless) that does not ship with a tank. Consequently, all purified water is instantaneously generated and consumed (without waiting in a tank) which will increase the purified water health and quality benefits.

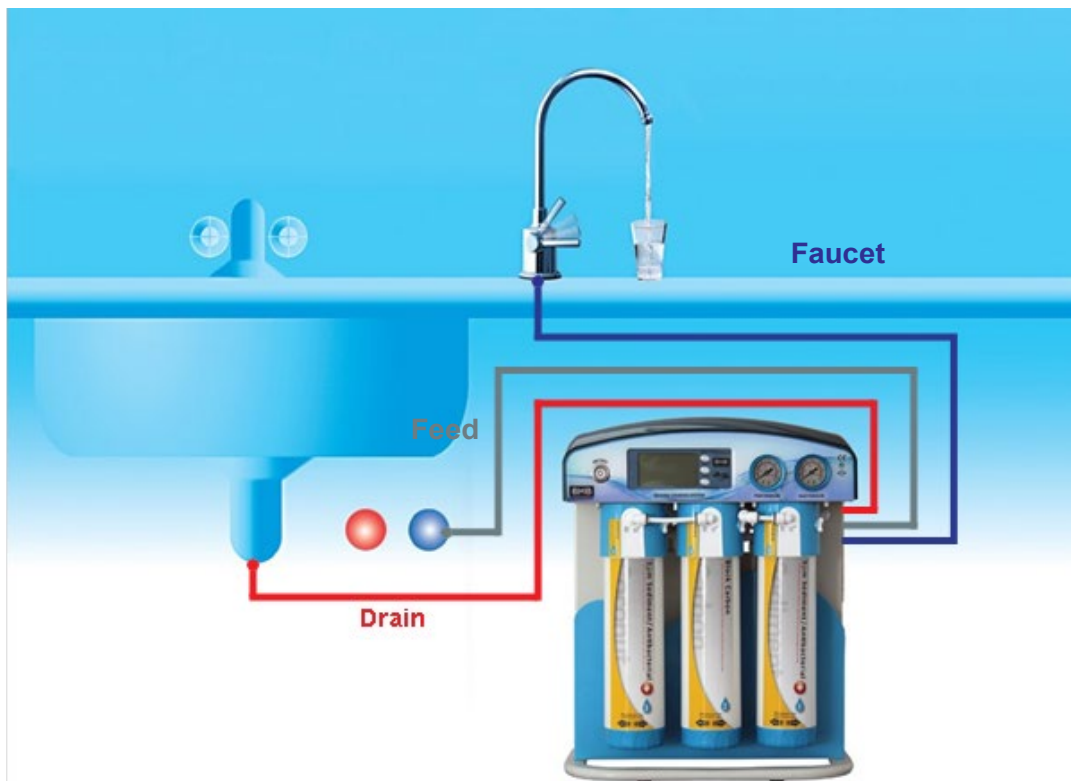

Nova Pro with Tank installation diagram for higher capacity and low pressure

In specific cases such as low feed water pressure or high-capacity use, the BMB Nova Pro model can be installed with a tank. For these situations simply remove the quick connect plug on the “Tank” water connection port of the system and make a connection to an adequately sized tank. Please contact a **BMB Technology** dealer for more information.

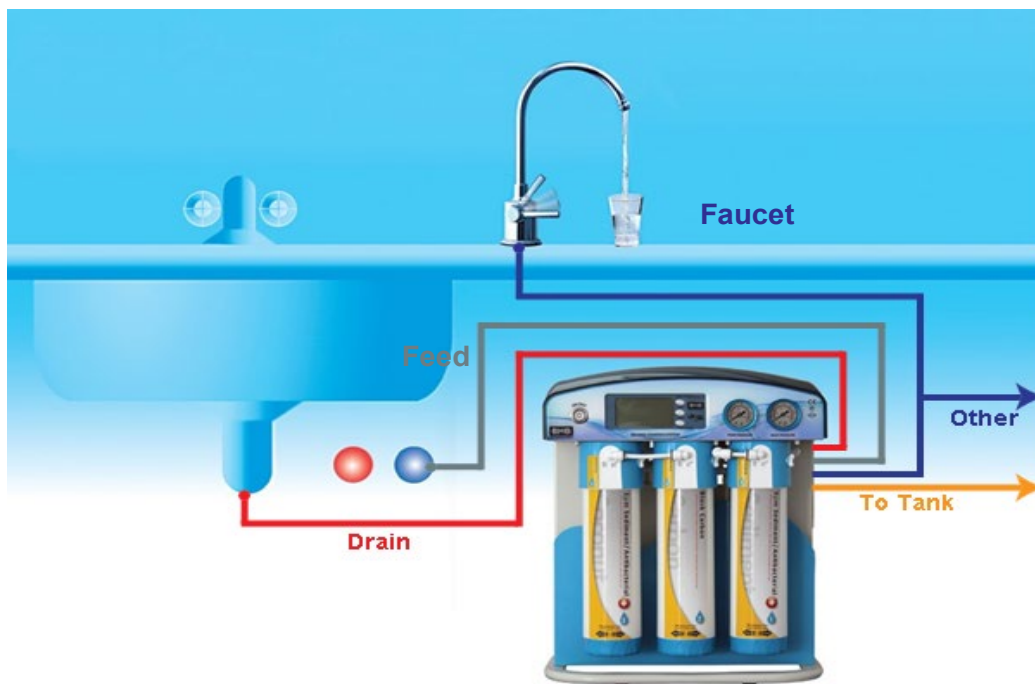

Using 'Quick connect fittings' (push fit)

Quick connect fittings (push fittings) are used in a wide variety of plumbing, heating, electrical and fire suppression systems. Quick connect works by inserting the tubing into a connection mechanism that deploys fastening teeth onto the tubing surface. When opposing force is applied to the union, the teeth are forced deeper into the tubing, preventing separation of the union. The advantages of using quick connect fittings are:

- *They offer a significant time saving benefit over traditional connectors*
- *They tend to have less user failures compared to traditional connectors*
- *They require little skill or strength for their usage*
- *They do not require any tools to use and maintain them*

Please see below for an exploded diagram of a basic quick connect fitting.

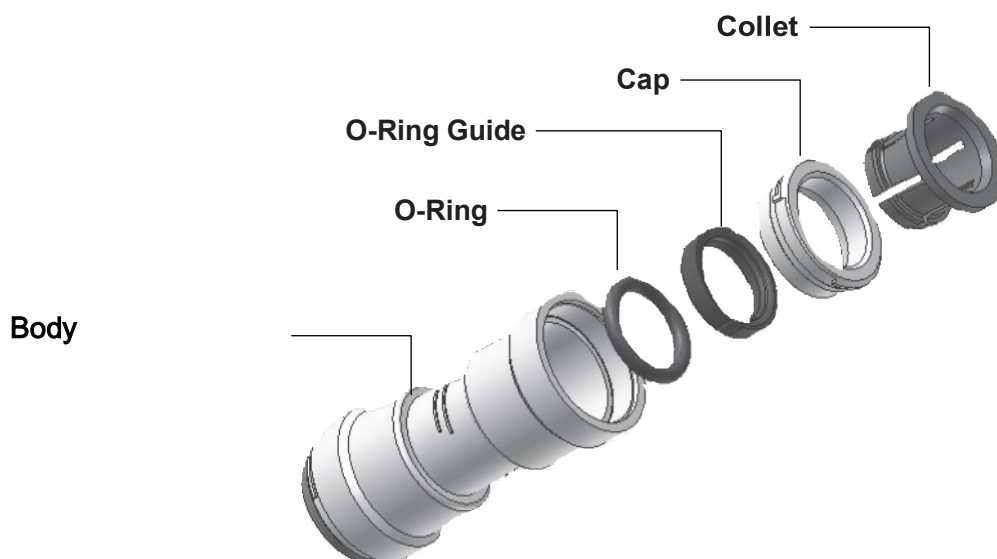

Exploded Diagram of a Quick Connect Fitting

Using push fit connections

Step 1: It is essential that the outside diameter of the tubing being inserted into the fitting is completely free of scratch marks, dirt and any other material. Inspect the outside of the tubing carefully.

Step 2: It is also very important that the sliced edge of the tubing is cut cleanly. If the tubing needs to be cut, use a sharp knife or scissors. Make sure to remove all burrs or sharp edges before inserting the tubing into the fitting.

Step 3: The fitting grips the tubing before it seals. Lightly push the tubing into the fitting until the grip is felt.



Step 4: Now push the tubing into the fitting harder until the tube stop is felt. The collet has stainless steel teeth which hold the tubing in position while the O-ring provides a permanent leak proof seal.



Step 5: Pull on the tubing away from the fitting and make sure it stays firmly in place. It is good practice to test the connection with pressurized water before finishing installation.

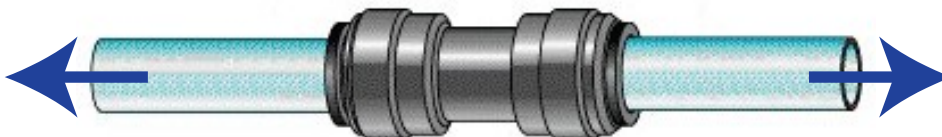

Step 6: To disconnect the tubing from the fitting, ensure that the system is depressurized first. Push in the collet squarely against the face of the fitting. With the collet held in this position, the tubing can be removed by pulling. The fitting and tubing can be reused.



Nova pro supplied installation components-



Saddle connection



PTFE Tape



Feed connection 3/8 & 3/4 supplied



3/8 & 1/4 tubing



300 GPD Membrane Housing Wrench



Elbow connections



Faucet Tap

Tube cutter & push fit release tool

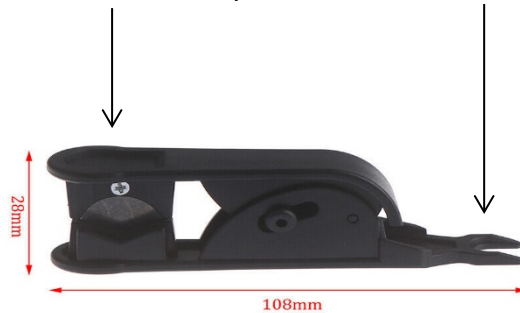

Nova pro installation steps

- 1, Check available space for installation of nova pro- select location for nova pro.
- 2, Check for Electrical socket- install new socket or use extension cable
- 3, Install supplied faucet tap or install upgraded 3 way tap

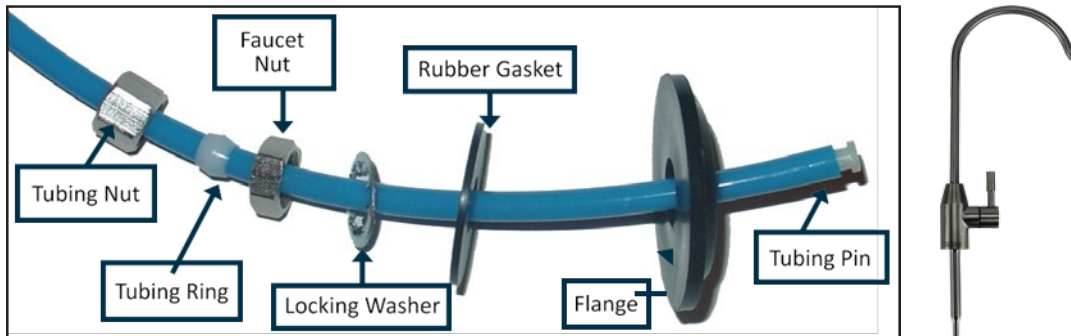

- 4, Install Feed connection on cold water tap connection

*****Insert black washer correct way

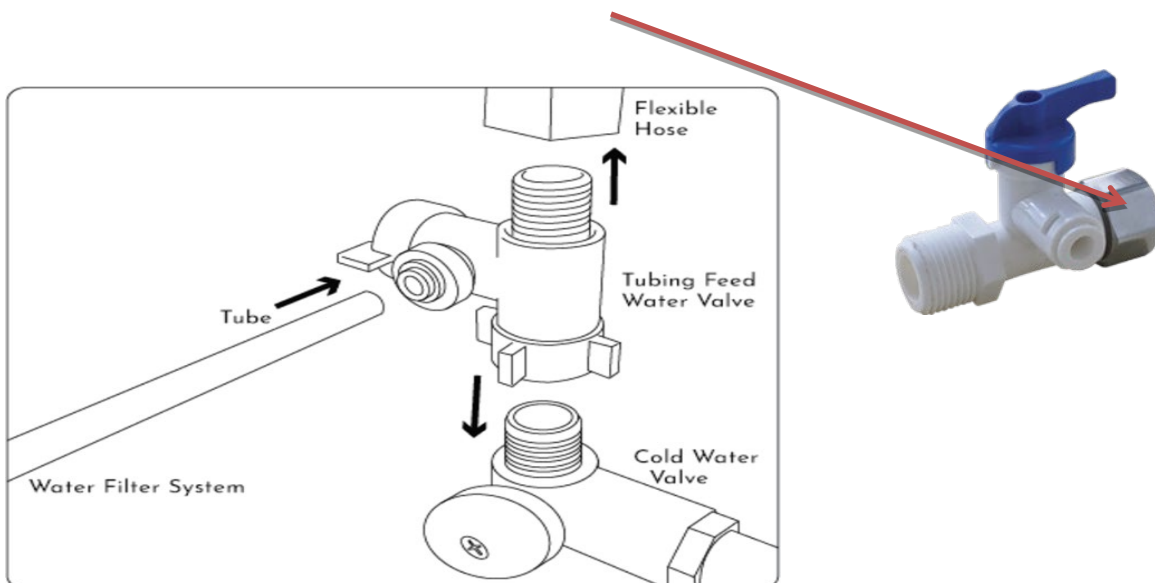

***Other fittings may be required depending on existing plumbing configuration



5, Install drain saddle connection

Select a location for the drain hole based on the design of the plumbing. The drain saddle should be installed above the u-bend if possible, on a vertical tail piece. Locate the drain saddle away from the garbage disposal to prevent potential contamination and system fouling. Use a 7 mm (1/4") drill bit to drill a small hole in the drain pipe for the drain to pass through. Clean the debris from the plumbing and hold before continuing.

Remove the backing from the foam gasket and stick that half of the drain saddle on the drain pipe so that the holes line up (a small drill bit or other long narrow object can be used to help align correctly). Place the other half of the drain saddle on the opposite side of the drain pipe. Clamp and loosely tighten the drain saddle using the nuts and bolts included. Use a Phillips screwdriver to tighten the drain saddle. Connect the tubing from the drain saddle quick connection to the "Drain" connection on the system

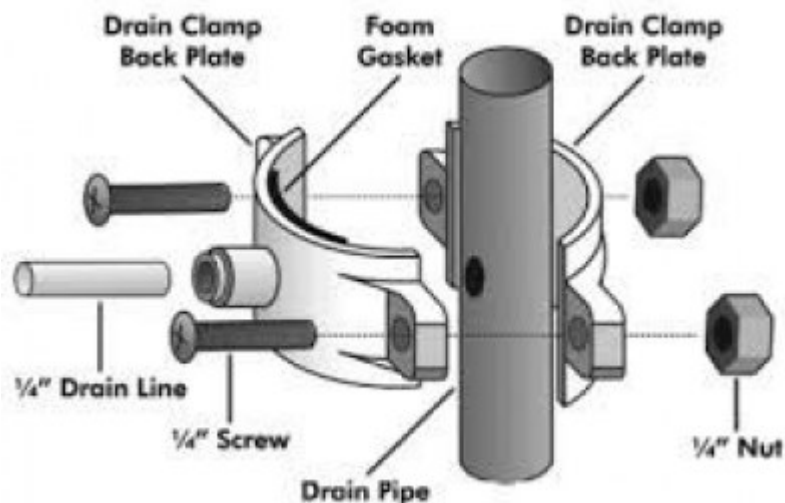

6, Install 2 x RO Membranes

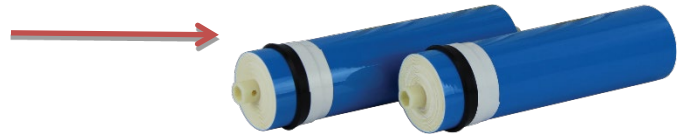

The RO membranes are supplied in a sterile vacuumed pack. To install remove all plugs in connection ports to release any system pressure build up. *Replace TANK plug.



Remove housings as illustrated below and use supplied key to open membrane housing. This can be very tight, install membranes with membrane black washer to the top and refit in reverse order.

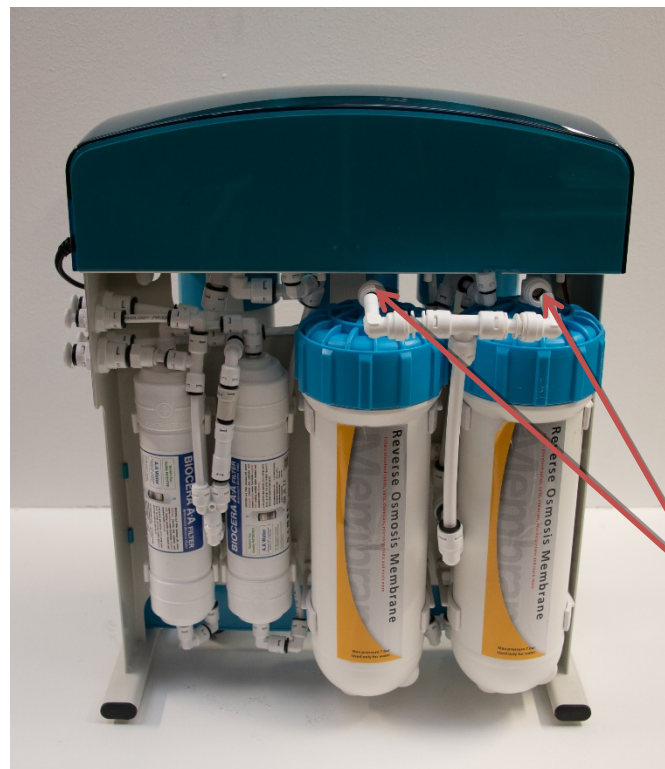

release

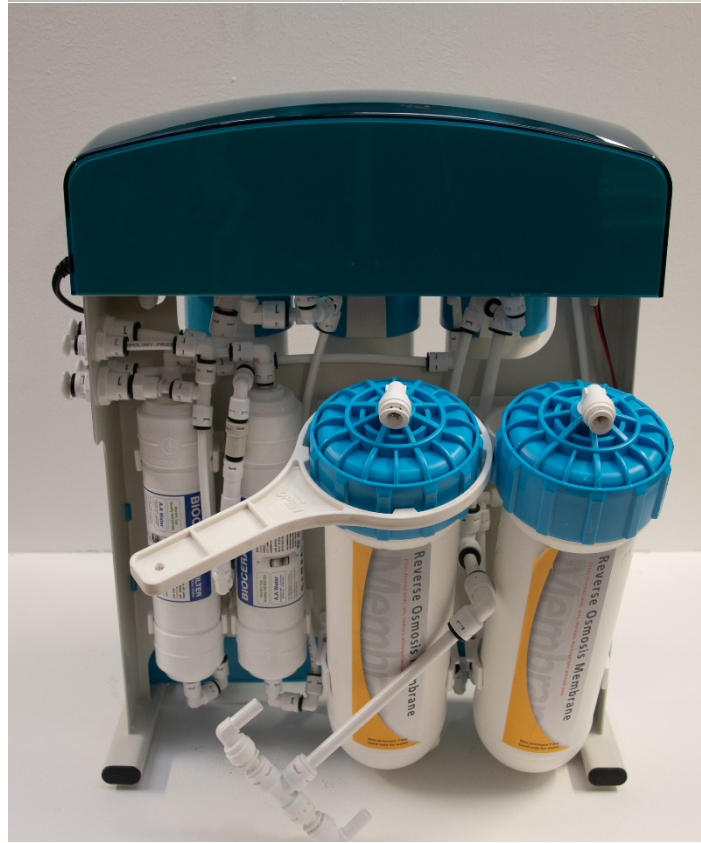
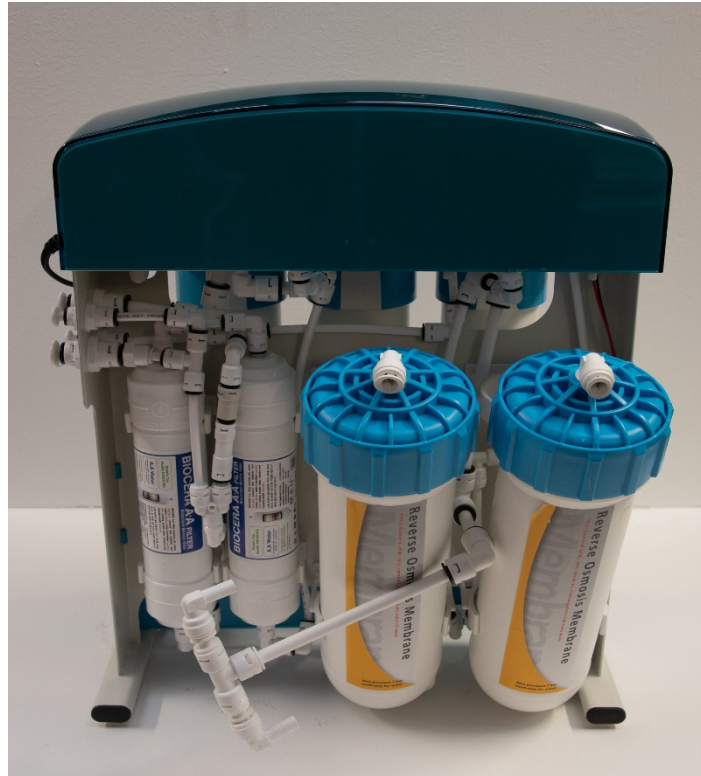



Insert RO membranes
& refit in reverse
order

7, Connect tubing to correct ports on Nova Pro to correct Inlets/outlet connections

***Connect the unit leaving plenty of length on the tubing so you can lift the Nova Pro in & out of its final position for ease of filter change and maintenance.**

Connect -Feed water, Drain Water, Clean Water.

Use Elbow connections if required on Nova pro Ports.



When replacing RO Membranes after usage lifespan,
please refer to Pre & Post filter change Page 35-36 for
procedure and commissioning Page 28-29

7a, Install TANK if required

Use PTFE tape to connect tank valve to tank and connect with tubing to TANK port on Nova Pro



8, Start up and Commissioning

a, Once all of the connections are made from the previous sections, check the connections and open the filtered water faucet tap/open the filter tap if a new 3-way tap has been installed. This will allow for pressure to not build up in the system during start-up and this will allow the 'flush' of the system

b, Open the feed water valve and turn Nova Pro on.



During system boot up process, the system will sound a series of beeps and the LED lights on top and front of the system will activate.

After the beeps, the system will commence by first a "flush" process which can be observed from the on-board digital panel. In this process the membrane sheets are washed by high flow water that goes directly to the drain line. This process will last for 90 seconds and the system will next enter the "pump" cycle which also can be observed from the digital panel. In this process the system will start producing water which can be seen running from the faucet.

The system should run with the faucet open for 8-10 minutes.

Once the faucet is turned off, the system will remain in the "pump" cycle until it is fully pressurized. Once this is done, it will be followed by a short "flush" cycle of 5-10 seconds to make sure any residuals left on the membrane sheet surface is flushed to drain. Next, the system will go into "Tank Full" mode where it is in stand-by waiting to produce water. The LED lights are automatically turned off in the "Tank Full" mode. Additionally, the TDS reading is not active and will display "000 PPM" on the screen (TDS is only measured actively during Flush and Pump cycles).

These cycles will repeat during and after each use of the system. It is important to note that the long flush cycle is only activated during system first time boot or by manually pushing the "Flush" button on the front interface.

c, Verifying the Installation

While the system is waiting in stand-by in the “Tank Full” mode, inspect all of the water connections and make sure there are no leaks (the system should be given 10-20 minutes to make sure the pressure has stabilized enough). Do not forget to open the top cover of the system and look for leaks inside.

***Please note tiny bubbles will appear in the water which will dissipate & the flow rate will be slow while the filters become saturated with water.**

Again, while the system is in the “Tank Full” mode, read the “Inlet Pressure” and make sure that it is above 2.5 bars. (If it is below 2.5 bar a tank will be required)

This is the feed water pressure to the system and it will not operate efficiently under this pressure. Please see Figure below to locate the “Inlet Pressure”.

If the inlet pressure is above 6 bar a 3/8 inline pressure reducer must be fitted

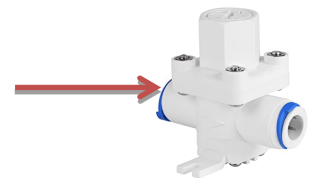

Inlet pressure

Pump pressure

Digital interface

All of the models covered in this Installation, Operation & Maintenance Manual come standard with the proprietary **BMB Technology** digital controller. The digital controller enhances the system performance and user experience. It will display produced water TDS & temperature, track filter lifetime, perform auto-flush of membranes, monitor operation mode, protect system from common failures and much more.

The digital controller has three buttons in the front for the user to interact with: Menu, Login and Flush.

Menu Button :: Used to reset filter lifetime. The default filter lifetime that the system ships with is 12 months. Press and hold to reset filter lifetime.

Login Button :: Press once and release to display days left until the next filter change.

Flush Button :: Press once and release to flush the membranes and bring fresh water into the system.

When 30 days remain until end of filter lifetime, the controller will make a sound alarm every 12 hours to remind the user to make preparations to change the filter. Once "0" days are achieved, it has been a full 12 months since the filters were first used. Now, the controller will start to count the days in negative numbers for the filter lifetime (-1, -2, -3, -5 ...-10, etc.) to signify number of days past filter lifetime.

From 0 days to -30 days of filter lifetime the controller will make a sound alarm every 2 hours to remind the user to change the filters. From -31 days to -60 days of filter lifetime the controller will make a sound alarm every 1 hour to remind the user to change the filters. On the 61st day, the controller will lock the system from producing water and display "Loc" on the screen.

At any time, the user can reset the filter lifetime to the original value of 12 months by pressing and holding the menu button.

Digital Interface diagram

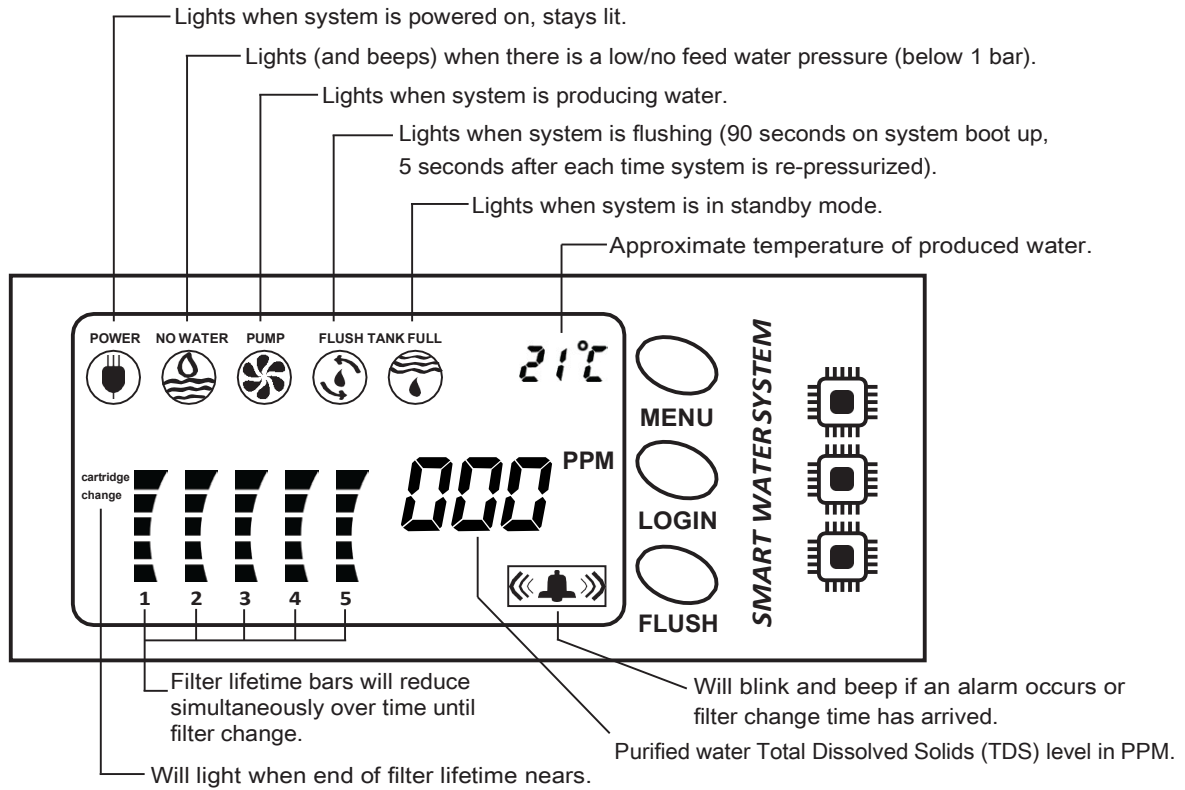

Maintenance

Water filter technology has come a long way over the last 20 years. Now, filters can run at higher filtration efficiencies with a longer filter lifetime. There is also a significant amount of added value and technology that can be incorporated into the filters.

BMB Technology takes advantage of water filtration technology to produce the highest quality water at the lowest cost of ownership. The filter lifetimes are generally longer for **BMB Technology** systems when compared to other systems in the market. However, it should be well noted that there are currently no water filtration systems in the world that are designed to be run until all of the filters clog. In fact, some filters fail by opening of the pores as opposed to clogging.

It can generally be stated that the filter lifetime starts once the filters touch water. Even if the user goes on prolonged periods of not using the system (such as vacation) or the water consumption is low, the filter lifetime does not stop or slow down. This is true because the filters are made from organic compounds such as paper, coconut shell, minerals, etc. and they will degrade in water over time.

Additionally, changing of the filters is a “Preventive Maintenance” as opposed to a “Corrective Maintenance”. This means that filters are changed in order to prevent future failures whereas corrective measures are done after a failure has taken place.

For the above reasons, **BMB Technology** system filters are given a lifetime of time as opposed to volume. It would be very difficult to count the volume of water produced over time. Furthermore, in order to give a volume based filter lifetime, one would also need to know the instantaneous incoming water quality (chlorine levels, sediment load, chemicals, etc.) in order to adjust the relative volume of end of filter lifetime.

*We recommend every 12 months for the Pre and post filters change with up to 3 years on the RO membrane change. This is dependent on incoming water quality and usage.

Annual Sanitization

Because this system uses disposable filters in which the inside filter element and the outside casing (housing) get changed every year, only the tank for tank-based systems needs to be sanitized.

Going on holiday

This system has been designed so the user goes through minimal effort to prep the system for extended non-use (going on holiday). Simply follow the steps below to prepare the system for extended non-use and start-up after extended non-use.

1. Close the feed water valve that supplies the system
2. Open the faucet until no more water comes from the faucet
3. System will give a "No Water" alarm, this is OK
4. Turn off the system from the on / off button
5. Unplug the system electrical connection
6. System is ready for extended non-use

Upon return, follow the procedures on start up.

In the event of a leak, turn off the water supply to the Nova Pro

Trouble shooting matrix on next page

Problem	Cause	Solution
Fitting leak	Tube is not joined tightly Tube is not cut straight Fitting not installed properly	Remove and rejoin the tube Cut the tube straight through the cross-section Remove fitting, wrap new teflon and re-install
Drain saddle leak	Drain saddle is not installed properly Pre-filter not tightened until "click" heard	Reinstall drain saddle per the installation manual Remove filter and install again, make sure to hear click
Pre-Filter Leak	O-ring on top of pre-filter damaged or not seated correctly Membrane housing cap not tightened correctly	Inspect the o-ring. Make sure it is seated correctly. Use the membrane housing wrench to tighten cap
Membrane Housing Leak	O-ring damaged or not seated correctly Low feed water pressure Feed water valve closed Low pressure switch cable came loose	Inspect the o-ring. Make sure it is seated correctly. Make sure inlet water pressure manometer above 2.5 bars Make sure to open the feed water valve Make sure to connect low pressure switch cable (yellow color)
"No Water" alarm	Filters are clogged Tubing is kinked Loss of air pressure in tank	Replace the first 4 filters Make sure no tubing bends more than 45 degrees Empty tank and pressurize to 6-8 PSI
Little or no water comes from faucet	Low feed water pressure	Make sure the feed water pressure is min. 2 Bar
Controller cycles between: "No Water" - "Pump" - "Flush"	Check valve damaged Solenoid valve damaged Autoflush valve damaged	Replace check valve Replace solenoid valve Replace autoflush valve
Controller cycles between: "Pump" - "Flush"	Flow restrictor clogged	Replace the flow restrictor
No Waste water or membrane clogged in few days	Membrane filter damaged Post-filters near end of life	Replace membrane filter Replace the post filters
Produced water has a high TDS value	Air is in the system	During first installation air will almost always be present in the system. In a few days the system will automatically purge all of the air from the system. Air may also appear in some cases where the feed water pressure temperature is significantly different from room temperature.
Produced water is milky or cloudy. Goes away after a few minutes		
Water has a eggy smell and tastes sour	Biofilm buildup in the system Punctured tank bladder	Sterilize the tank If tank is full of water (heavy) this is the case, replace tank
Very little water comes from the tank	Over pressure in tank bladder Tank valve is closed	If tank has little water inside (light), empty tank, release tank air pressure down to 5-7 PSI Open the tank valve

Pre and post filter change procedure – Lift unit out of position and have some towels to hand

Once the time has come to change the filters, the system has to be prepped for the procedure. Since the system is continuously under pressure, failure to follow these directions can lead to water leakage.

1. Close the feed water valve that supplies the system
2. Open the faucet until the system is fully de-pressurized
3. System will give a “No Water” alarm, this is OK
4. Turn off the system from the on / off button
5. Unplug the system electrical connection, lift out of position & change filters as shown.

Pre filters

The pre-filters have a locking mechanism on the top to make it easy for filter change. In order to remove old filters from the system, simply bring the lock to the open position with one hand and twist the pre filters in counter-clockwise fashion with the other hand until they are completely detached from the system.

When installing the new pre filters, lubricate black seals with potable grease, insert the top of the filters into the empty filter cap. The filter may need to rotate a bit back and forth until the thread locking is felt. Now rotate the pre-filter slowly in clockwise fashion until the click of the lock is heard. Now the filter is successfully installed.

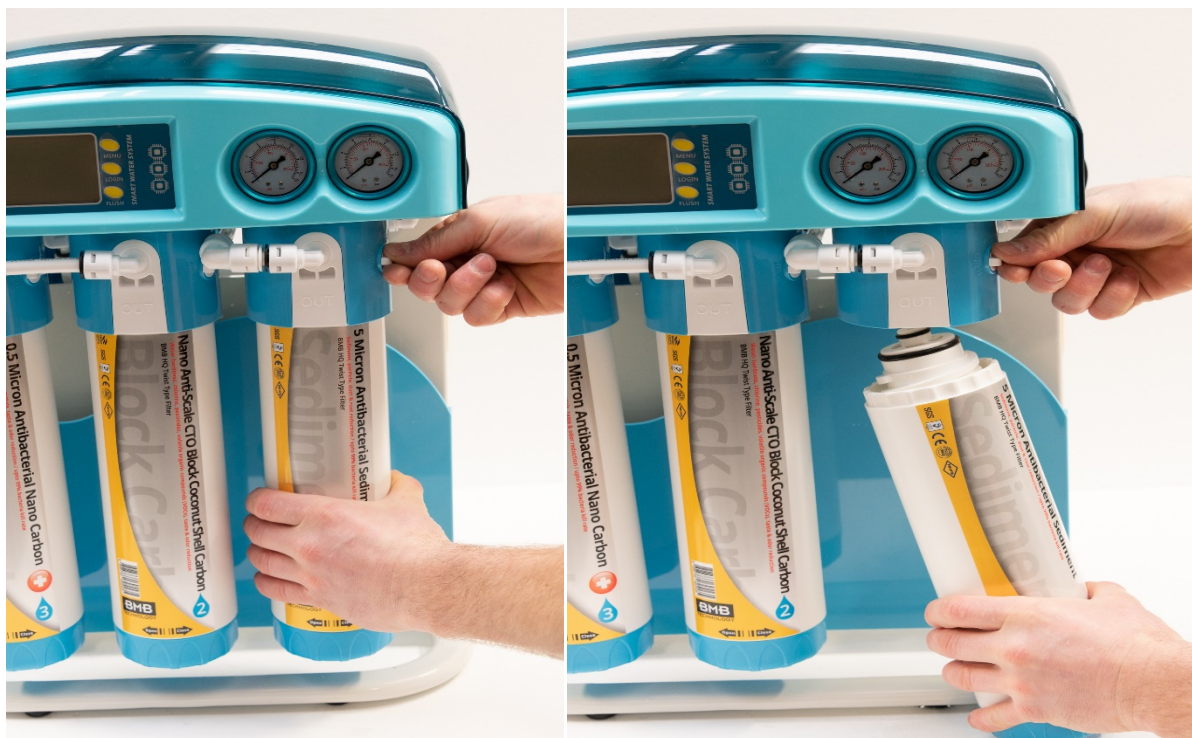

Post Biocera A-A Filter change- *Note directional flow and replace correct direction

The 2 Biocera A-A post-filters on this system have quick connect tubing and fitting connections. Simply remove the inlet and exit quick connect fitting elbows for the post-filters and replace with the new filters.

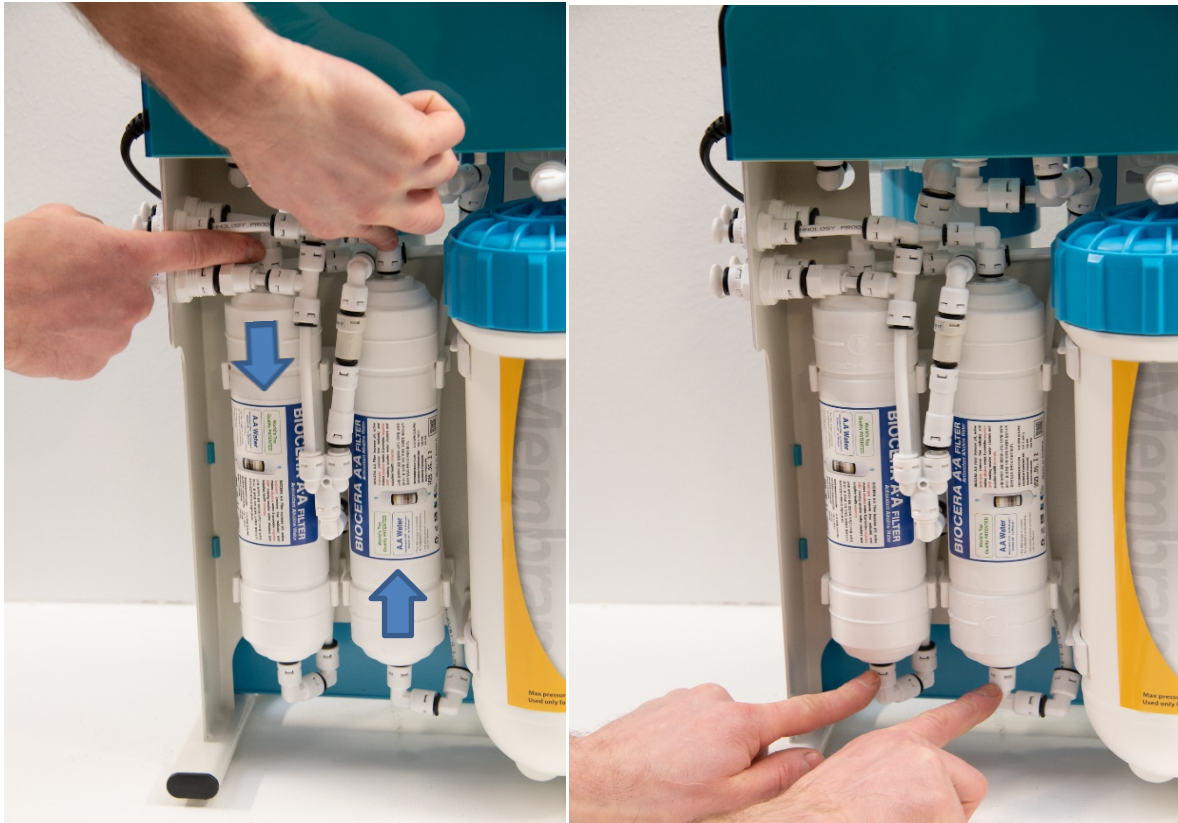

To change membranes, refer back to page 24-26

***Lubricate black seals with potable grease on membrane change**

To verify filter change, refer back to start up and commissioning page 28-29

Warranty Registration

Please fill out the information below and keep for your records.
Please also send a copy to your **BMB Technology** dealer or **BMB Technology** Headquarters by simply taking a picture of it with your smart phone and mailing it to info@bmbtechnology.com.

First Name: _____ Last Name: _____

Full Address: _____

Mobile Number: _____ Email: _____

Date of Purchase: _____ Date of Install: _____

Where Purchased: _____

Installed By: _____

Model Number: BMB NOVA PRO

Limited Warranty

Guarantee

This **BMB Technology** product carries a 2 year warranty against material and manufacturing defects and does not cover any charges incurred due to professional installation. The warranty will be valid from the date of purchase as shown on the sales invoice. Please keep the invoice for your records. This product is intended for domestic use only. The warranty does not apply to products installed outside of a domestic environment. This warranty is not assignable or transferable.

Warranty

What is covered by the **BMB Technology** warranty?

- The repair or replacement of a part or all of your system if your system is found to be defective due to faulty materials or manufacturing issues within 2 years of purchase at **BMB Technology's** discretion.
- If any part is no longer available, **BMB Technology** reserves the right to replace it with a suitable alternative.

Terms and conditions of the **BMB Technology** 2 year guarantee

- The guarantee is valid for domestic use.
- The guarantee becomes effective at the date of purchase.
- Under the terms of the warranty, proof of purchase is required.
- This warranty provides more benefits and coverage than standard statutory consumer rights.

BMB Technology does not guarantee the repair or replacement of a product that has failed for any of the following reasons:

- Defects resulting from improper installation (including repairs or alterations), from abuse, misuse, misapplication, improper maintenance, neglect, alteration, accidents, casualties, fire, flood, freezing, environmental factors, water pressure spikes or other similar factors.
- Normal wear and tear.
- Accidental damage or faults caused by negligent use or care, misuse, neglect, careless operation and failure to use the system in accordance with the operating guidelines.
- Failure to change the water filter cartridges in accordance with the instructions in this manual.
- The use of anything other than genuine **BMB Technology** replacement parts, including the water filter cartridges.
- Failures of or failures caused by parts that were not supplied with the product.
- Incoming water that is microbiologically unsafe or of unknown quality without adequate disinfection before or after the system.
- Equipment that is relocated from the site of its original installation.

This warranty will be void if defects occur due to failure to observe the following conditions:

1. The product must be hooked up to a potable, municipal cold water supply.
2. The hardness of the water should not exceed 17.5 grains per gallon or 250 ppm.
3. Maximum incoming iron in the feed water must be less than 0.2 ppm.
4. The feed water pH must be between 6.5 - 8.5.
5. The feed water pressure must be between 36 and 87 PSI (4 - 40 bar).
6. The feed water temperature must be between 39 - 104 °F (4 - 40 °C).
7. The feed water TDS must not exceed 500 PPM.
8. Other technical specifications and feed water requirements listed in this manual must be followed.

How do I make a claim under my **BMB Technology** 2 year warranty?

- If you are in doubt about what is covered by your guarantee, or wish to discuss a claim, please email info@bmbtechnology.com. Please have your receipt to hand.
- **BMB Technology** reserves the right to alter, change or modify product specifications without prior notice.

