

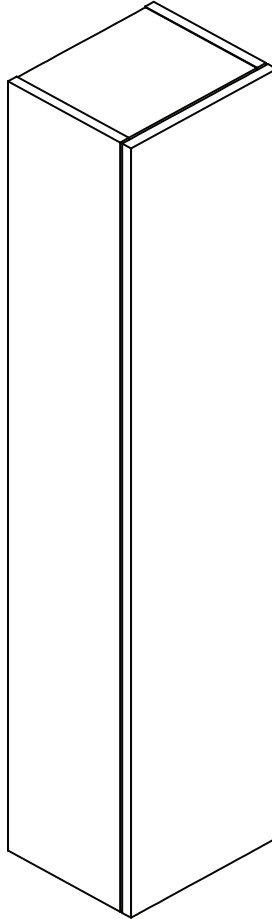

## Wall Hung Tall Unit







## Fitting Instructions

Please follow them carefully and  
leave this manual with end user

## Before you begin:

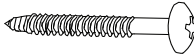
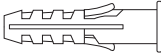
1. **We recommend that this product is installed by a qualified tradesperson**, Victorian Plumbing Ltd. accept no liability for products incorrectly installed or any damage to the floor, walls, plumbing, vanity cabinet or personal injury during installation.
2. **Check the chosen wall space for any pipes/cables prior to drilling**
3. **We recommend that Wall Mounted Tall Units must be fastened to a load bearing wall. Check the type of wall you are fixing into and use suitable fixings.**
4. Observe all local plumbing and building codes & regulations.
5. Unpack the product then read these instructions before proceeding. Inspect the product for damage. If any damage is found, contact our Customer Relations team.

## Items Included:

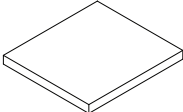
No.	Description	Picture	Qty
A	Tall Unit		1
B	M5x50 Screw		2
C	Ø8x35mm Rawl Plug		2
D	Shelf support		12
E	Washer		2
F	Cover cap		2
G	Shelf		3

## Tools Required (Not Included):

\*Ensure the appropriate PPE is used during installation\*



Pencil

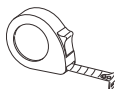

Tape Measure



Drill



Screw Driver



Spirit Level

# Installation

Diagrams are for illustration purposes only. Your Tall Unit may superficially differ from these drawings however the installation guide steps still apply.

## Step 1:

- Set the unit at the desired height, then mark the positions of the pre-drilled holes at the back plinth of the unit.
- Drill the holes in the wall using the appropriate sized drill bit, then insert the rawl plugs.

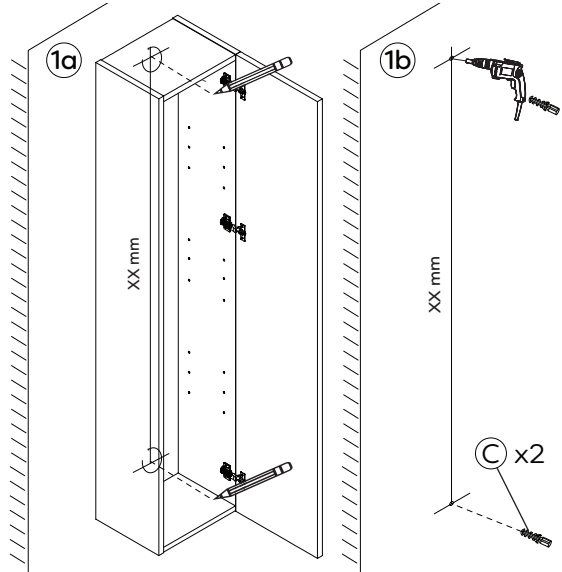

## Step 2:

- Place the unit up against your chosen wall. Using the washers and screws provided. Secure the unit to the wall by screwing into the rawl plugs, then insert the cover caps over the screws.

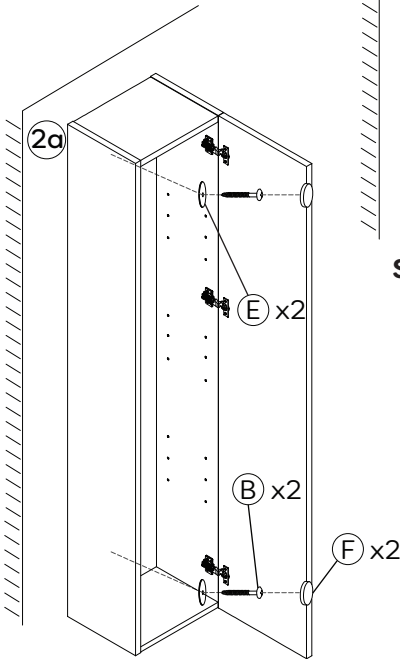

## Step 3:

- Insert the supplied shelf supports into the pre-drilled holes at the desired height, then place the shelves on-top of the supports. Check that the shelves are level.

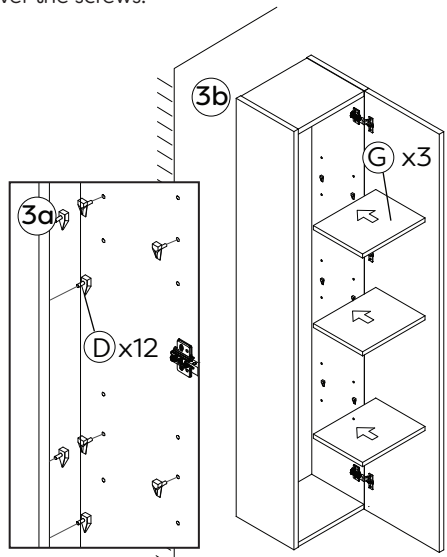

## Door Drilling & Hinge Adjustment

- Some doors are supplied non-drilled for the handles/knobs so that the end user can create the exact look that they want to achieve. Select your desired handle position. Always measure twice before drilling to make sure that the handles will be in the correct position. Check that the hinges and internal components are not in the way of where the handles will be drilled.
- Using an appropriately sized drill bit, drill through the back of the door into a scrap piece of wood to help prevent splitting.

**NOTE:** DRILLED DOORS CANNOT BE RETURNED.

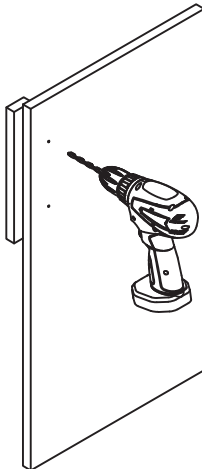

### HINGE ADJUSTMENT

(Adjustment applies when door is mounted)

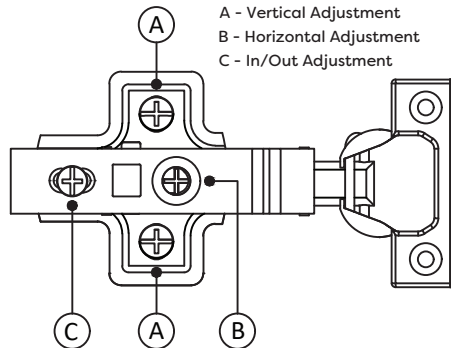

### Door Hinges:

These should be wiped out with a damp soapy cloth and wiped dry with a soft cloth as necessary. The hinges are lubricated and should not be cleaned with a degreasing agent as this will affect the action of the moving parts. Never lean on partially or fully opened doors in order to gain access to the units. The hinges are specified to adequately support the weight of the door, plus small additional weights such as wire accessories. It is advised that once the bathroom has been installed you should check every six months that all screws on the hinges are tight.

**Please Note:** Unit is water resistant, but not waterproof. All spillages and splashes should be wiped dry, failure to do so may shorten the life expectancy of the product and invalidate any guarantees.

### Recycling and Disposal:

Please recycle the packaging in accordance with your local government regulations on waste handling and follow the same advice at the end of the products life.