

ASQUITHS

BATHROOMS OF TRANSFORMATION

SHOWERS FITTING GUIDE



GENERAL FITTING GUIDE

CONCEALED 2/3/4 WAY DIVERTER VALVE

PRODUCT SHOWN WILL VARY
DEPENDING ON MODEL

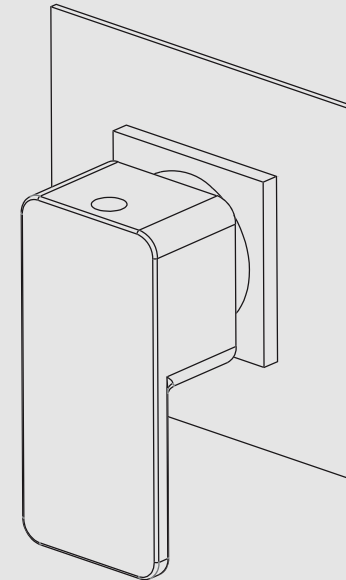

Important Information

(Please leave this installation & user guide with the end user)

This installation guide is for a concealed 2/3/4 way diverter valve. It covers the installation and operation of the fitting.

The water feed to this product will need to come via a suitable valve that has a built in on/off function (there is no on/off control with this diverter valve).

These diverter valve models are operated manually, and are designed with multiple outlets which will allow up to four shower accessories to be used (only one shower accessory can be used at once as these are not designed for a "split" water flow between ports).

Two blanking caps are also supplied to allow the installer to cap off any ports that are not required

Safety

We recommend that this product is fitted by a fully qualified installer. The installation must comply with all current water regulations. Please note: This valve MUST be commissioned during installation to suit site conditions. In order for this product to operate as designed it must be installed and commissioned as stated in this manual.

Components List



OUTLET BLANKING CAP
x2 (Fit where applicable)

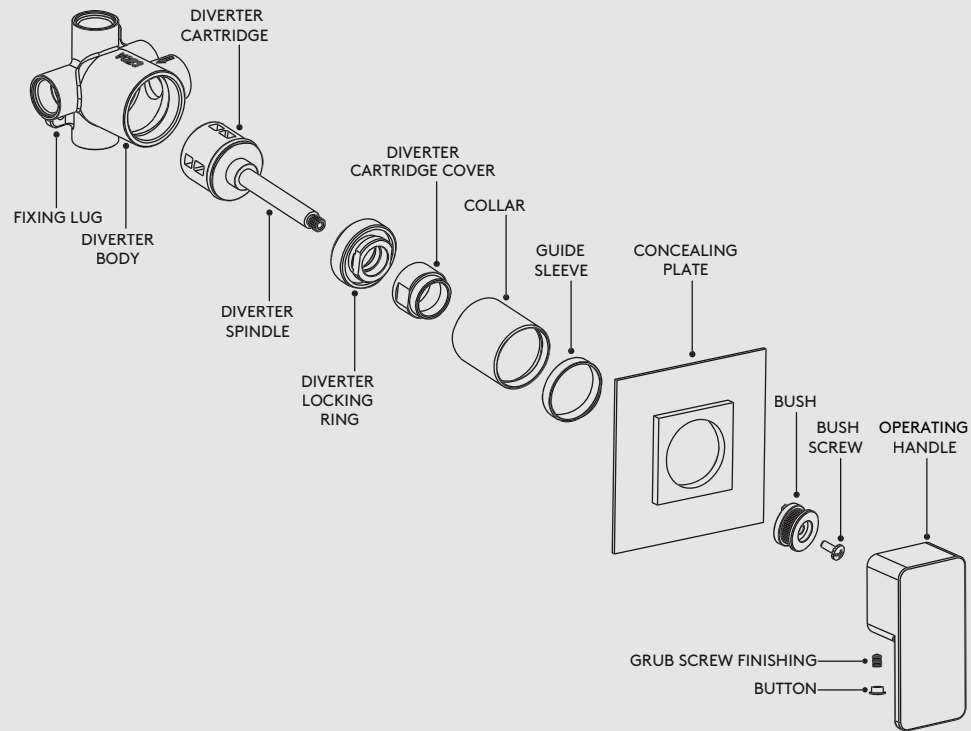

Key Dimensions

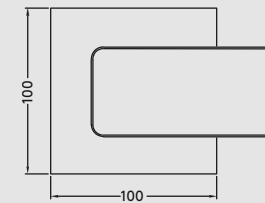
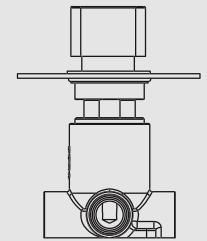
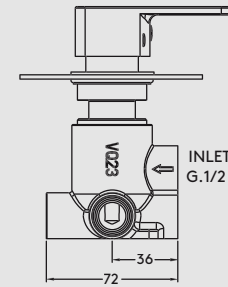
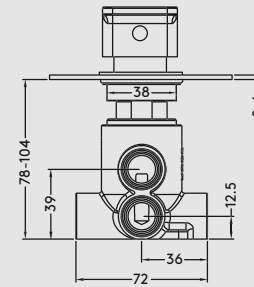
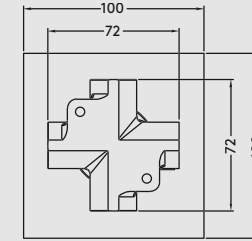
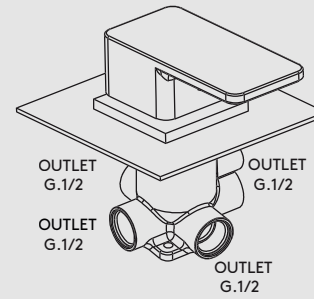

Operation

Turning the operating handle will switch the water flow between the various outlet options (up to four) Two blanking caps are supplied to allow the installer to cap off any ports that are not required. This diverter valve is designed to operate only one shower accessory at a time, and they are not designed for a "split" water flow between ports. There is no on/off built into this diverter valve.

Installation

NB There is some in-wall adjustment on this Diverter valve to assist with installation. This needs to be planned before installation commences. See key dimensions for guidance.

1. Remove the collar and guide sleeve from the diverter body, and leave to one side in a safe place.
2. Determine the fixing position and make a suitable recess in the wall to house the diverter body.

NB this space should leave enough access to be able to service the diverter body and all its connection points after the concealing plate is removed.

3. Secure the diverter body in position to a suitable fixing point, using the fixing lugs that are cast into the diverter body (fixings not supplied).
4. Now the diverter body is securely mounted in the wall recess, make sure the pipe work is thoroughly flushed through to remove any debris from the system before connecting the water supplies to the diverter body. NB Failure to do this could invalidate the guarantee.

NB The mixed water must flow through the diverter valve as indicated by the flow directional arrow. The diverter will not operate correctly if this step is not followed.

5. The plumbing connections should then be made to the inlet & outlets as required. At this point the installer can cap off any ports that won't be used (2 blanking caps are supplied with the fitting).
6. Turn on the water supplies and check for leaks.
7. The diverter valve can now be commissioned.
8. Re-fit the collar and guide sleeve to the diverter valve.
9. Push the concealing plate over the collar, applying a small bead of silicone behind the concealing plate to create a water tight seal so that water cannot ingress into the wall cavity.
10. Fit the operating handle to the diverter spindle.
11. Your diverter valve is now ready for use.

Aftercare

- When cleaning the valve please do not use a substance that could possibly damage the surface finish. We recommend that soapy water with a mild detergent is used.
- Please take care not to damage the surface finish of the valve. The finish is polished chrome and can be easily marked.



ASQUITHSBATHROOMS.COM