

AREZZO

Installation Guide

**Mono Basin
Mixer Tap**

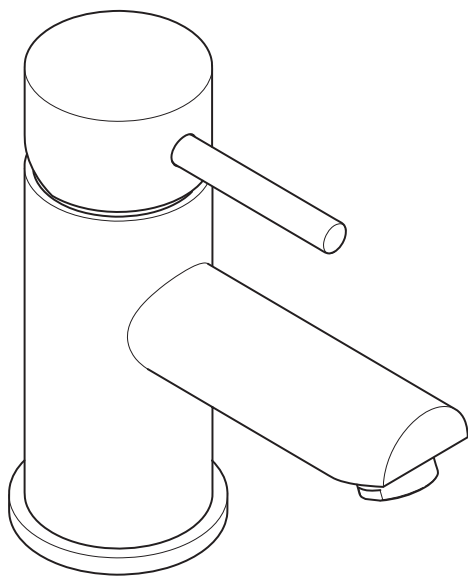

AREZZO

Installation Guide

Mono Basin Mixer Tap

Pre Installation Notes

To maintain the tap's appearance, please ensure it is cleaned regularly using a clean soft damp cloth only. Abrasive cleaners or detergents must not be used as they may cause surface deterioration.

Bathroom products are vulnerable to household acid damage. Products like hair dye, disinfectants, denture cleaner etc may contain acids that may be harmful to your product. Contact with these should be avoided.

Important Information



**Max Pressure
5 Bar**

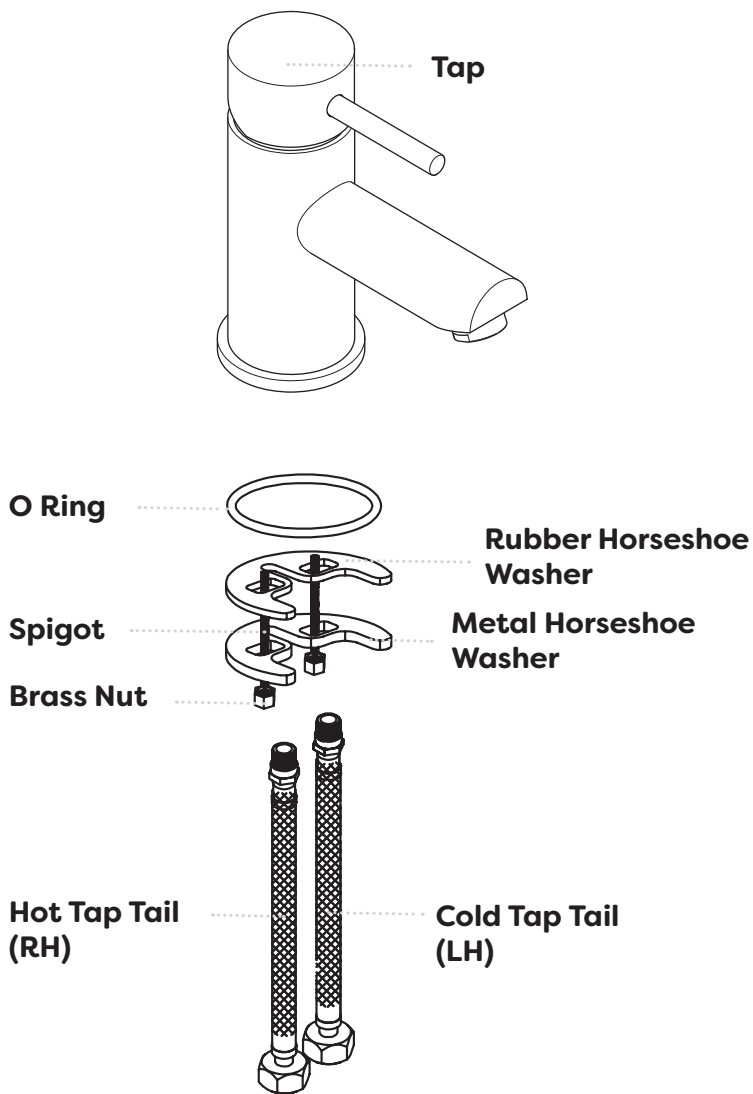

Diagrams are for illustration purposes only. Your tap may superficially differ from this drawing, however the installation guide steps still apply.

Step One

Screw the threaded spigot bars into their locator holes on the underneath of the tap body.

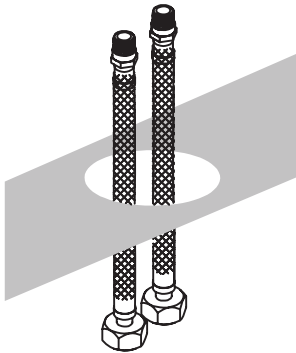
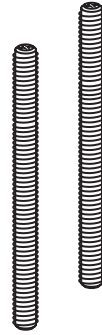

Step Two

Feeding them through from underneath the sink hole, fit the water inlet flexi tail(s)/ connector(s) by hand to the tap body.

Note: Do not over tighten.

Step Three

Carefully assemble new fitting onto sanitary ware fixing the rubber and metal horseshoe washers to the underneath of the basin. Do not overtighten as this may cause damage to the fitting and the sanitary ware. Remember to install the O ring, collar and washer (where applicable) between the tap body & sanitary ware.

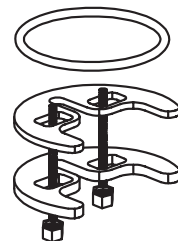

Step Four

Connect flexi tail(s)/inlet connector(s) to the mains water feed. The hot supply should be connected to the left-hand side when viewing the installation from the front.

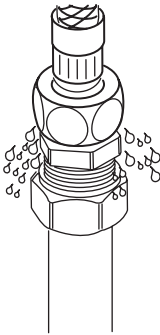
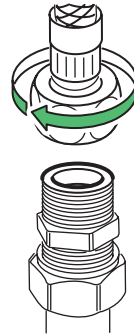

Step Five

Place the tap handle in the 'Open' position and turn on the water supply. Allow the tap to run for 90 seconds to clear any debris from inside. Use this time to identify any wet areas or potential leaks.

Step Six

Turn tap handle to 'Closed' position.

AREZZO