

# AREZZO

## Arezzo Square Fluted Twin Concealed Shower Valve

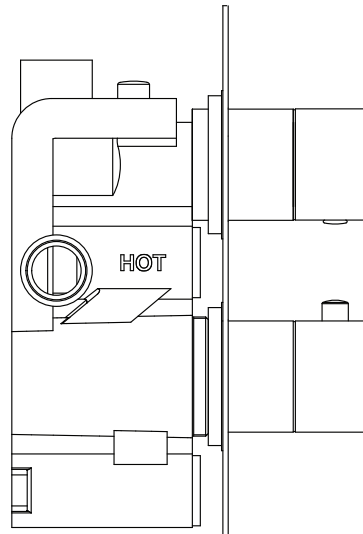
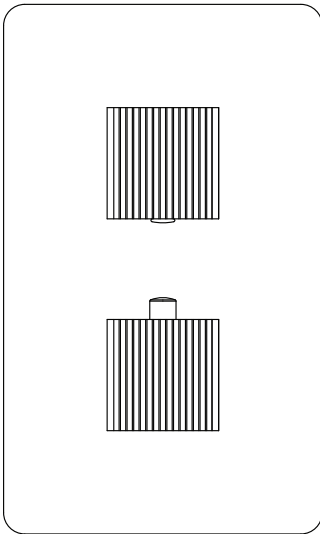

## Fitting Instructions

Please follow them carefully and  
leave this manual with end user

## Before you begin:

1. **We recommend that this product is installed by a qualified tradesperson,** Victorian Plumbing Ltd. accept no liability for products incorrectly installed, or where the correct testing procedures have not been adhered to, thus resulting in the escape of water and consequential damage.
2. Ensure the incoming mains water supply is switched off prior to commencing the installation.
3. Observe all local plumbing and building codes & regulations.
4. Unpack the product then read these instructions before proceeding. Inspect the product for damage. If any damage is found, contact our Customer Relations team.

**Fig. 1**

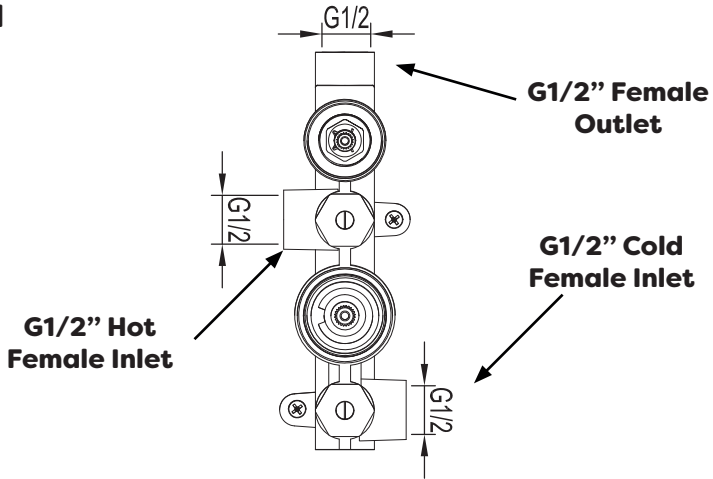

**Fig. 2**

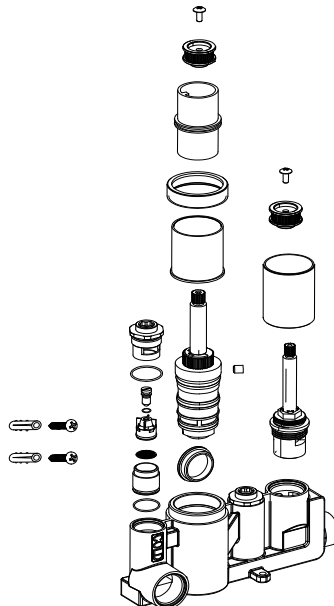

Diagrams are for illustration purposes only. Your shower valve may superficially differ from this drawing however the installation guide steps still apply.

## Installation:

1. Determine the fixing position for the valve and make a recess in the wall to house the valve. The depth of the recess should be 80mm to 100mm within the finished wall surface to fit the cover plate correctly.
2. Insert the valve into the wall recess, then mark the fixing points with the mounting lugs that are cast on the valve body. Pull the valve out and drill suitable length holes at the marked positions. Use supplied plugs and screw to secure the valve.
3. Now that the valve body is securely mounted to the wall (prior to installation and connecting) make sure that the pipes are thoroughly flushed to remove any debris etc. (failure to do this will impair the flow of the water).
4. The Plumbing connections should then be made to the hot and cold inlets which are clearly marked (**see Fig. 1**). The hot water inlet is to be connected with the hot supply on the left of the valve and the cold water inlet is to be connected to the cold supply on the right of the valve. Make sure that they are correctly connected, otherwise the thermostatic cartridge will lose it's function of controlling the temperature and may scald.
5. Make the plumbing connection to the water outlet. This will take the water to the chosen shower kit you have selected to run with this shower.
6. The plumbing connections on the inlets and outlets are 1/2" BSP female thread. It is recommended to apply PTFE tape to all thread connections to ensure a water tight seal.
7. Turn on the water supply to ensure that there are no leakages.
8. Slide the plate into position over the lock sleeve and fit this up against the wall surface.
9. Fit the control handles making sure that the stop lug (of the bottom stop ring) is positioned at "12 O' clock" and that the markings of both stop rings (top & bottom) are in line. Remove any decorative caps then place the handle on the above stop ring; holding the handle firmly in position tighten, using the screw and Allen Key provided. Be careful not to turn the stop ring when tightening.

## Fitting the handles:

1. Remove the arm from the control knob by unscrewing and detaching the protruding arm. Remove the threaded grub screw from within the arm. Take care not to lose these items.
2. Place the control knob onto the valve shaft. Secure the control knob using the threaded grub screw and tighten with the Allen Key provided.
3. Finally, re-screw the arm back onto the control knob. Repeat this task for the other control handle.

## Operation Notice:

1. The work condition for use of this product is cold water 4-29°C, hot water 55-85°C and water pressure 0.1 bar - 10 bar. To avoid the differential pressure between hot water and cold water, the thermostatic cartridge is preferably under the condition of water pressure 3 bar, hot water 65°C and cold water 15°C .
2. Make sure the shower valve is off when no water comes out of it (especially when nobody resides in the house or during the period of decoration or the absence of water).
3. When the room temperature drops below 0°C , take necessary measures (such measures as keeping shower valve warm and closing windows) to prevent the shower valve from being frozen or even broken (especially when windows kept open for air ventilation while nobody resides in).
4. Do not disassemble the valve unless you are an expert.

Diagram:

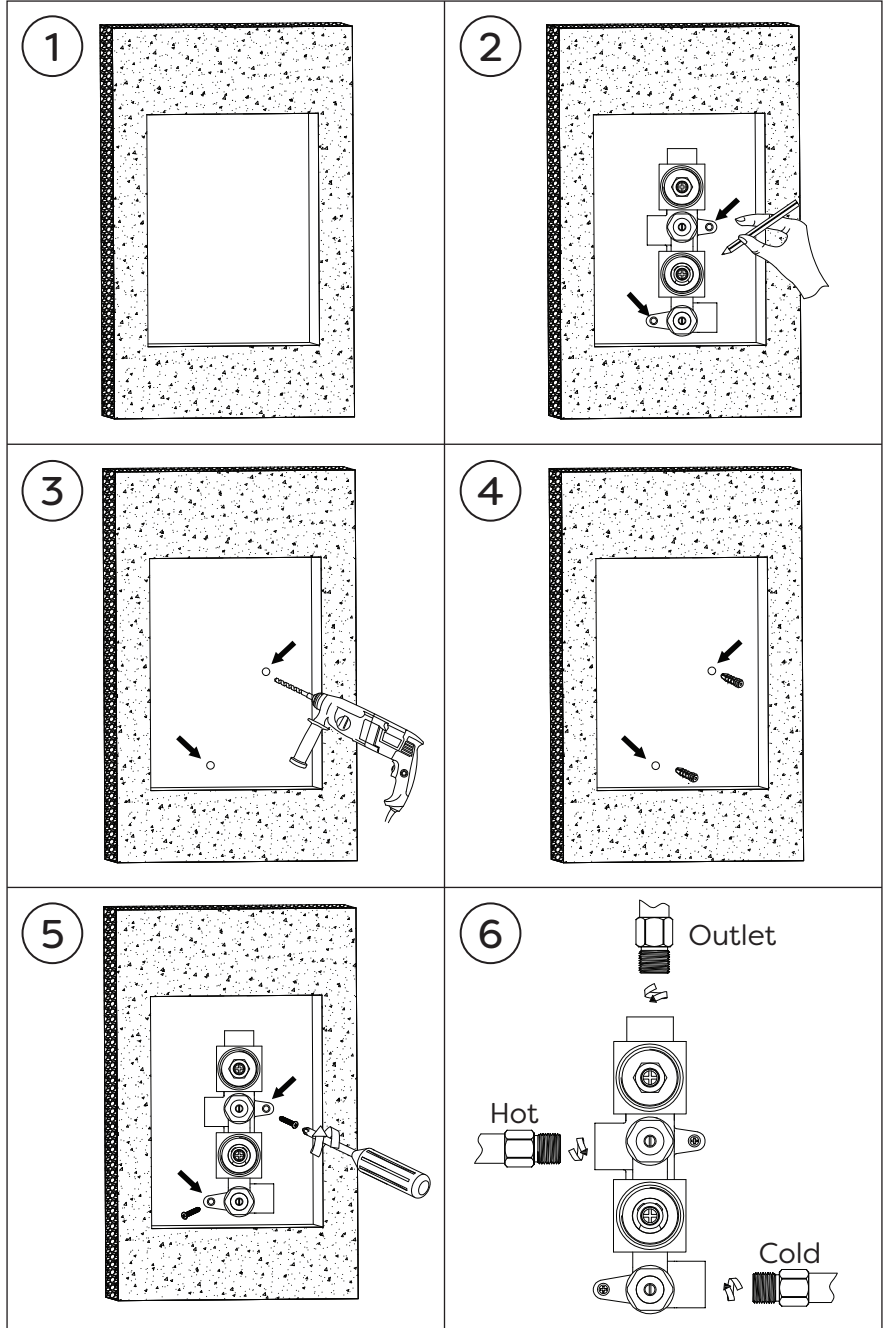

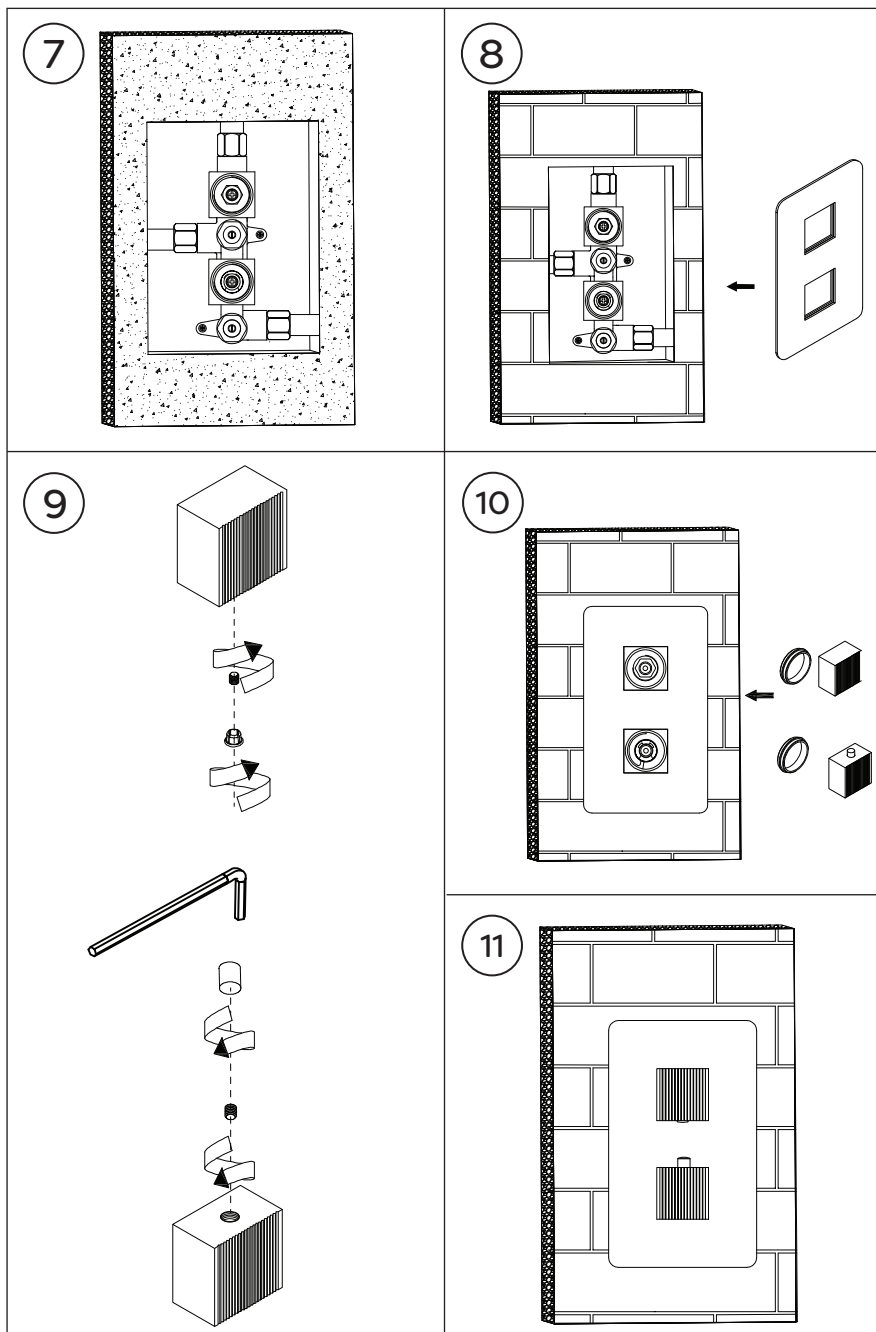

Diagrams are for illustration purposes only. Your shower valve may superficially differ from this drawing however the installation guide steps still apply.

## Operation:

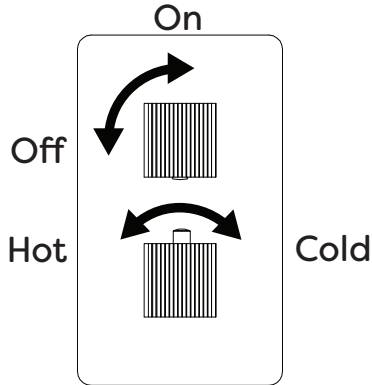

Ensure that the control handles are positioned correctly to avoid obstruction.

## Temperature Adjustment:

1. The maximum temperature is factory set at 38°C. If you think it is not enough, you can adjust the above stop ring position to get a higher maximum temperature.
2. Remove the handle on the thermostatic control. The spline and above stop ring will be shown.
3. Remove the above stop ring by loosening the set screw. Turn the shower flow control fully on.
4. Make sure the stop lug on the below stop ring is positioning at 12 o'clock. Be careful not to turn the spline. Turn the above stop ring clockwise, place it back on to the spline. The maximum temperature will be higher. Allow water temperature to stabilise and check temperature. The maximum temperature must never exceed 46°C.
5. Achieve the temperature you want, turn the flow control off, and refit the handle.

## Maintenance:

If the water flow is less than normal and temperature control is imprecise after a period of usage. It is often due to the poor water which blocks the small filter net. The cleaning method: First, turn off the main valve, remove the control handles and cover plate. Then unscrew the end caps on the hot/cold water inlet sides of valve body with an Allen key. Now you can clean the small filter net with brush and vinegar. After completion, rinse it and reassemble all the parts back. At last, check the water flow and temperature control.

## Aftercare:

Always clean the surface of shower valve to keep it bright. **Attention:** please do not use inappropriate tools such as sharp brushes, rough sponges, scouring pads or corrosive detergent to clean the shower valve. Please clean the shower valve by wet cloth and soapy water after each time of usage. Then rinse the soap out with clean water and dry with a soft cotton cloth.

# Troubleshooting

FAULT	POSSIBLE CAUSE
Shower only runs hot or cold after installation	<ol style="list-style-type: none"><li>1. Hot and cold supplies have been plumbed the wrong direction.</li><li>2. Faulty thermostat.</li><li>3. Insufficient water pressure.</li></ol>
Shower does not run hot enough	<ol style="list-style-type: none"><li>1. Check the hot water supply temperature.</li><li>2. Maximum temperature needs adjusting, see temperature adjustment.</li><li>3. Blockage in the hot supply.</li></ol>
Hot water in cold supply or vice versa	<ol style="list-style-type: none"><li>1. Check and clean non-return valves.</li><li>2. Check Hot and Cold supplies have not been reversed during installation.</li></ol>
Leaking when in the off position	<ol style="list-style-type: none"><li>1. Possible blockage/debris in the system.</li><li>2. Operating conditions are incorrect.</li><li>3. Valve shut off has been activated due to a pressure drop in either the cold or hot supplies.</li></ol>
Leaking when in the off position	<ol style="list-style-type: none"><li>1. Debris in the flow control cartridge.</li><li>2. Faulty control cartridge.</li></ol>
Fluctuating flow	<ol style="list-style-type: none"><li>1. Dynamic inlet pressure are not balanced.</li></ol>

## Notes:

[www.victorianplumbing.co.uk](http://www.victorianplumbing.co.uk)