

AQUALISA Q™

EXPOSED CONTROLLER INSTALLATION GUIDE



INDEX

COMPONENTS	PAGE 3
SAFETY INFORMATION	PAGES 4 & 5
GRAVITY SYSTEMS	PAGE 5
HIGH PRESSURE/COMBINATION BOILERS	PAGE 5
CONNECTION TO SUPPLIES	PAGE 6
FLUSHING	PAGE 7
Q™ CONTROLLER INSTALLATION	PAGE 8
ATTACHING ACCESSORIES	PAGE 15
WALL MOUNTED FIXED HEAD	PAGE 16
CEILING MOUNTED FIXED HEAD	PAGE 19
BATH OVERFLOW AND FILLER	PAGE 21
COMMISSIONING	PAGE 24
WATER SAVE MODE	PAGE 25
CLEANING AND MAINTENANCE	PAGE 25
TROUBLE SHOOTING GUIDE	PAGE 26

COMPONENTS

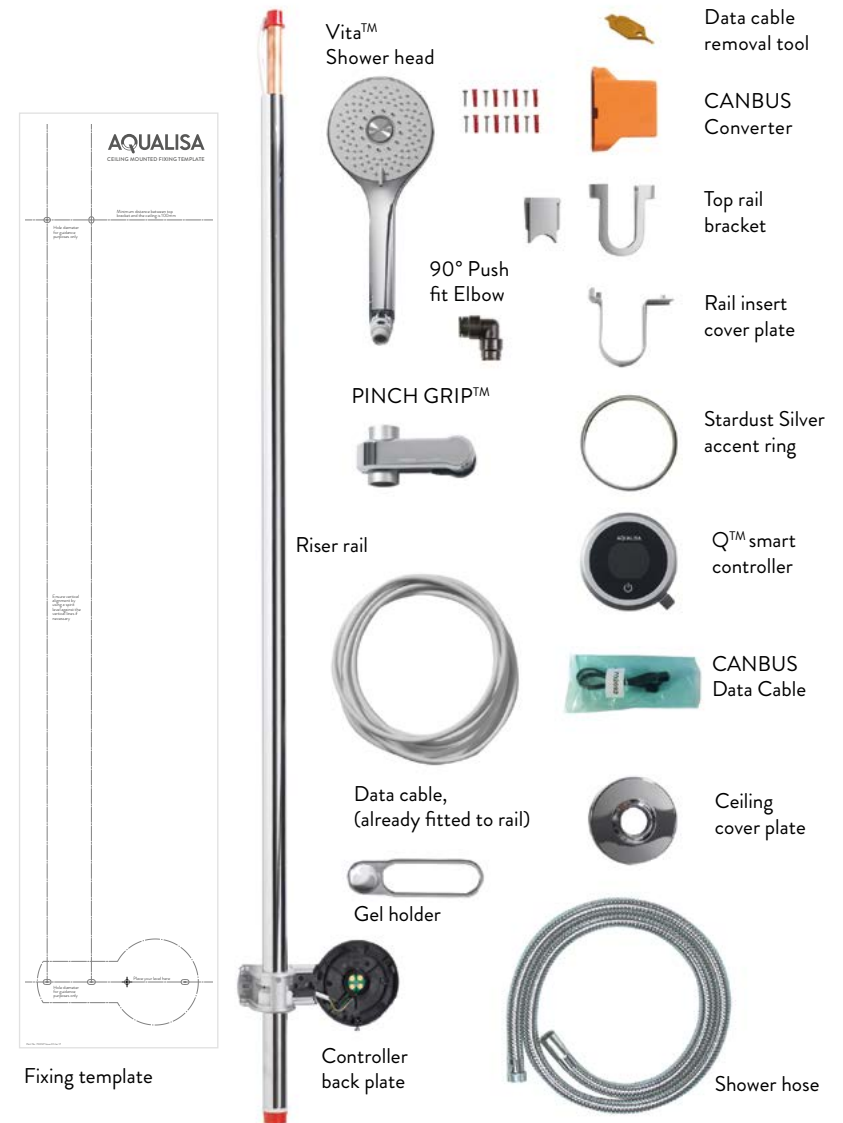

Quartz™ smart valve components not shown, refer to Quartz™ smart valve installation guide for more details.

IMPORTANT INFORMATION

Safety information

This product must be installed by a competent person in accordance with all relevant current Water Supply Regulations.

ALL PRODUCTS REQUIRING AN ELECTRICAL CONNECTION MUST BE INSTALLED BY A QUALIFIED PERSON FOLLOWING THE LATEST REVISION OF BS 7671 (WIRING REGULATIONS) AND CERTIFIED TO CURRENT BUILDING REGULATIONS.

This system should be installed so that other taps or appliances operated elsewhere within the premises do not significantly affect the flow.

The Q™ shower systems must not be used with a hot water supply temperature of over 65°C.

The Quartz™ smart valve is supplied factory pre-set at maximum temperature of 45°C. The maximum temperature is fully adjustable to suit site conditions. If adjusted, we recommend the outlet temperature is set to a MAXIMUM of 46°C.

THE QUARTZ™ SMART VALVE MUST BE INSTALLED IN AN ACCESSIBLE LOCATION FOR SERVICING AND MAINTENANCE.

The Quartz™ smart valve must not be installed in situations where either the ambient temperature is likely to exceed 40°C or where freezing may occur.

The Q™ controller must not be installed in situations where the ambient temperature is likely to fall below 5°C or rise above 40°C.

We do not recommend the use of Q™ controller in steam therapy facilities.

This appliance must be earthed.

Cables which are chased into the wall must be protected by a suitably sized conduit or sheathing to allow for removal in the event of service and maintenance purposes. Ensure that the conduit is run to avoid the controller fixing holes.

Surface mounted cables must also be protected by a suitable approved conduit, even in a loft, where there may be a risk of

damage from vermin.

The power lead must only be replaced by the manufacturer or his accredited agent.

The Q™ controller is supplied from a safety low voltage source.

This product is suitable for domestic use only.

Aqualisa smart products are supplied complete with a 1 year guarantee that can be upgraded to 5 years by registering the shower with Aqualisa.

This product is not intended for use by persons (including children) with reduced physical, sensory or mental capabilities or lack of experience and knowledge, unless they have been given initial supervision or instruction concerning the use of the product by a person responsible for their safety.

Children should be supervised to ensure they do not play with the product.

Installation of pumped Quartz™ smart valve (for gravity stored systems)

The pumped Quartz™ smart valve is designed to operate up to maximum static pressure of 100kPa ((1 bar)(10 metres head) (14.5psi)).

Under no circumstances must the pumped Quartz™ smart valve be connected directly to the water main or in line with another booster pump.

The minimum actual capacity of the cold water storage cistern should be not less than 225 litres (50 gallons). The capacity of the hot water cylinder must be capable of meeting anticipated demand.

Installation of Quartz™ smart valve (for balanced high pressure and unvented systems, combination boiler systems and separately pumped gravity systems)

Pressures: The Quartz™ smart valve system is designed to operate up to a maximum static pressure of 700kPa ((7 bar)(100psi)). Where pressures are likely to exceed 700kPa ((7 bar)(100psi)), a pressure reducing valve must be fitted to the incoming mains supply. A setting of 400kPa ((4 bar)(60psi)) is recommended. It should be noted that daytime pressures approaching 600kPa ((6 bar)(80psi)) can rise above the stated maximum overnight.

Special notes for combination boiler systems

The appliance must have a minimum domestic hot water rating of 24kW (80,000BTU) and be of the type fitted with a fully modulating gas valve. If in any doubt, please contact the appliance manufacturer before installation commences.

PLEASE NOTE: DUE TO PERFORMANCE CHARACTERISTICS OF COMBINATION BOILERS, SEASONAL INLET TEMPERATURE CHANGE WILL AFFECT THE QUARTZ™ SMART VALVE OUTLET FLOW RATE RESULTING IN VARYING SHOWER FLOW RATES. INLET TEMPERATURE CHANGE MAY ALSO CAUSE THE TEMPERATURE DISPLAY TO FLASH; THIS IS NOT NECESSARILY CHANGING THE OUTLET TEMPERATURE.

Special notes for separately pumped gravity systems

We recommend a twin ended pump with a MINIMUM pump rating of 1.5 bar. For optimum performance a twin ended 2.5 bar pump should be used. The minimum actual capacity of the cold water storage cistern should be not less than 225 litres (50 gallons). The capacity of the hot water cylinder must be capable of meeting the anticipated demand.

THIS PRODUCT IS NOT SUITABLE FOR USE WITH A SINGLE ENDED PUMP.

FOR DIVERT MODELS A UNIVERSAL TWIN ENDED PUMP MUST BE USED.

Connections

This product incorporates 'push fit' type connections. Tube should be cut using a rotary type cutter and lubricated using a silicone-based lubricant or petroleum jelly (Vaseline or similar) prior to insertion into the fitting. If plastic pipe is used, the tube insert must not increase the tube diameter or extend the cut-off length by more than 2mm.

TO MAXIMISE FLOW RATES WE RECOMMEND USING COPPER PIPE WITH THE MINIMUM AMOUNT OF ELBOWS. THESE FITTINGS ARE NOT SUITABLE FOR STAINLESS STEEL TUBE.

Pipe sizing

Long pipe runs, on both inlet and outlet, will reduce the flow rate at the shower head. If long pipe runs are unavoidable, use copper pipe rather than plastic. If plastic pipe is used, minimise the number of elbows as the pipe inserts are very restrictive. Consideration should be given to using 22mm plastic or copper pipe especially if a diverter is installed.

Flushing

Some modern fluxes can be extremely corrosive and, if left in contact, will attack the working parts of this unit. All soldering must be completed and the pipe work thoroughly flushed out in accordance with current Water Supply Regulations prior to connection of the product.

Declaration of Conformity

Aqualisa Products Limited declares that the Q™ Controller, in conjunction with the smart valve, complies with the essential requirements and other relevant provisions of the Low Voltage Directive (2014/35/EU), the EMC Directive (2014/30/EU) and the RE Directive (2014/53/EU).



INSTALLATION



In addition to the guide below it is essential that the Important information section is read and understood and that you have all the necessary components before commencing installation. Failure to install the product in accordance with these instructions may adversely affect the warranty terms and conditions. Do not undertake any part of this installation unless you are competent to do so. Prior to starting, ensure that you are familiar with the necessary plumbing regulations required to install the product correctly and safely.

1

Install Quartz™ smart valve and diverter box (if applicable) following the separate installation guide.

2

Locate a suitable entry point in the ceiling or coving for the riser rail, avoiding joists and services. Position the rail assembly against bathroom wall in desired position and mark centre of rail on ceiling/coving.

The centre of the riser rail stands 45mm from the wall.



Positioning the Q™ controller

The Q™ controller is activated by a proximity sensor on the front of the Q™ controller. This sensor detects motion from up to 0.5m, directly in front of the device. It is therefore important that the device is positioned so that it will detect the user approaching and moving away from the shower at 0.5m.

The position should also be taken into consideration when utilising the Water Save mode, refer to point 63.



Helpful tip...

If coved ceiling remove the ceiling cover plate from the riser rail.

3

Drill a hole in the ceiling/coving that is a minimum Ø30mm maximum Ø40mm.



Helpful tip...

If the ceiling height is over 2.4m (8ft) a riser rail extension kit will be required. Contact our Customer Service department to purchase a 550mm riser rail extension kit, (Part No. 910596).

4

Affix the paper template to the wall in the desired location ensuring the shower controller is at a suitable height.



Helpful tip...

Use a spirit level where indicated on the paper template to ensure your template is square.

5

Mark the fixing points as indicated on the template.



Helpful tip...

Prior to drilling the fixing holes offer the assembly into position and check the following points:

The chrome riser rail is positioned within the drilled ceiling hole, (no copper pipe visible in the shower area).

There is adequate working clearance above the top of the rail in the roof space.

The controller is at a suitable height for all family members.

Location of the top bracket does not interfere with the maximum usage height of the PINCH GRIP™.

6

Drill the fixing points as previously marked using a suitable 6mm drill bit and fit the supplied wall plugs (if suitable).

7

Feed the data cable followed by the rail assembly containing the supply pipe through the hole in the ceiling.



8

Hold the riser rail assembly in position, secure the left hand fixing point of the bottom rail bracket (as shown).



9

Place the top rail bracket support pillar behind the riser rail and align with the fixing points.



10

Slide the fixing bracket over the rail and the support pillar and secure to the wall with the screws provided (if suitable).



11

Slide the top rail bracket cover onto the fixing bracket flush with the finished wall surface and click the sides firmly into position.



12

If being used slide the plate up to the ceiling to cover the entry hole.



13

Cut the cable tie and tilt the wall plate forward from the top to expose the rear of the wall plate. Remove the paper liner from the gasket, apply silicone sealant to the channel (as shown).

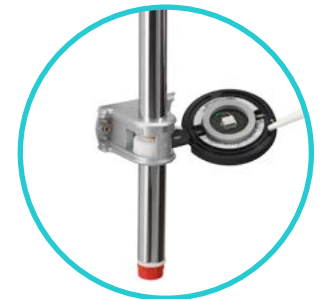

Helpful tip...

For cosmetic reasons we recommend using clear silicone.

14

Tilt the wall plate back and secure to the wall with the remaining 3 screws provided, (if suitable) ensuring the data cable is correctly located in the wall plate (as shown).



If supplied screws are not used, use a screw with the same size and head design, the screws used must be non corrosive.

Allow the silicone to set before moving to point 16.

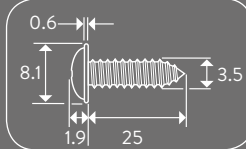

15

Slide rail insert cover into place.

Your Quartz™ smart controller is supplied with a colour accent ring that must be fitted. For fitting instructions refer to the user manual.



Power supply to the Quartz™ smart valve must be switched off before connecting the Q™ controller.

16

Position the Q™ controller into the wall plate with the power symbol at the 7 o'clock position. Gently apply pressure to the screen with one hand. Use the other hand to rotate the controller counter clockwise using the Q™ lever until it stops and is securely seated on the wall plate.

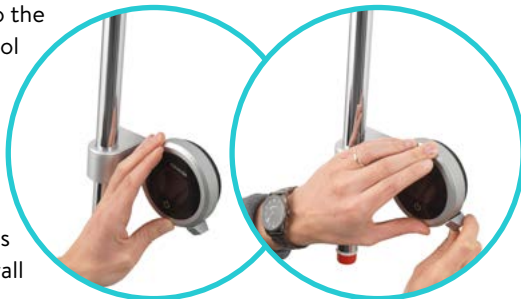

17

Tighten the screw located on the bottom of the Q™ controller.



Do not overtighten

18

If the Quartz™ smart valve is close to the shower then the cable can be trimmed. Ensure that a minimum 20mm of wire and 5mm of copper is exposed, (we recommend leaving minimum 100cm of cable spare).



The data cable must be run in conduit to allow for servicing and replacement if required. A minimum size of 15mm conduit is recommended.

19

Connect the 10m data cable into the CANBUS converter box following the wiring order as shown in the image and on the label. White (WH), Blue (BL), Black (BK), Red (RD).

Insert one end of the 500mm black CANBUS data cable into CANBUS converter.



Helpful tip...

If you connect the wrong wire use the supplied cable removal tool to remove the cable, any other tool may damage the CANBUS converter.



Only the supplied cable in the Green bag can be used. Do not use any another cable. If any other cable is used, damage will occur to the unit.

20

Remove top case of Quartz™ smart valve, plug in CANBUS data cable and replace top case. Fix the CANBUS converter box to joist/board with self-tapping screws provided.



If diverter is not being installed please proceed to point 22.



Helpful tip...

If installing a diverter, the Quartz™ smart valve secondary socket MUST be used to connect the Quartz™ smart valve to the diverter. This is located next to the Q™ smart valve main socket and is accessed by carefully snapping and removing the entry pillar.

21

Connect the 2m patch lead cable to both the diverter box and the secondary socket on the Quartz™ smart valve. Feed the cable out of the Quartz™ smart valve and diverter ensuring it is correctly routed within the data cable channel.



22

Run a supply pipe from the Quartz™ smart valve to the top of the rail assembly. If using a divert product run the supply from outlet A to the top of the rail assembly.



The 90° elbow must be used and kept easily accessible for future servicing and product replacement.
To ensure optimum performance use as few elbows as possible.
To maximise flow rates we recommend using copper pipe.
Run the outlet pipe from the Quartz™ smart valve or diverter to the top of the shower rail at a mildly upward gradient to reduce water dumping after use.

23

For divert products run a supply pipe from outlet B of the diverter box to the secondary outlet.

24

If installing a single outlet model, please go to point 60 for further instructions.

ATTACHING ACCESSORIES

25

Attach the hose to the base thread at the bottom of the rail. The hose must be tightened to point where washer forms a seal.



Current water supply regulations state that the handset should not be allowed to pass a point 25mm above the spill over level of the bath or shower tray. If this cannot be achieved, the hose must be passed through the gel hook which has been designed to be utilised as a hose restraint.

26

To attach the handset to the hose disengage the pivot clip from the bottom of the handset by pressing the tab and pulling the pivot hose connector clear.

27

Ensure the hose washer is in the correct position and screw the pivot hose connector into the hose.

28

Re-insert the pivot hose connector into the handset and push the tab to lock into position.



29

Insert handset into PINCH GRIP™ slider.



Refer to point 60 of commissioning instructions.

WALL MOUNTED FIXED HEAD

30

Cut the outlet pipe to the finished length (55mm – 150mm measured from the finished wall surface) using a rotary type cutter. If a hacksaw is used, the pipe end must be carefully de-burred and chamfered. Slide the wall spacer down the projecting pipe flush with the finished wall surface.

31

Slide the spacer on to the projecting pipe flush with the finished surface.



32

Ensure the pipe is clean and free of dust and slide the fixing bush onto the pipe flush with the wall spacer.



33

Slide the fixed head arm over the fixing bush flush with the wall surface and mark the four fixing points.

34

Carefully remove the fixed head arm and drill and prepare the fixings using the fixings provided, if suitable, taking care to avoid pipework hidden in the wall.

35

Ensuring the fixing bush is clean and free of dust, fit the 15mm O-ring against the end of the fixing bush. Lubricate the O-ring using a suitable silicone based lubricant.

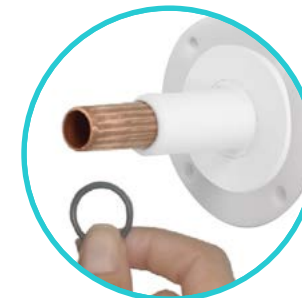

The O-ring must be positioned on the 15mm pipe flush to the fixing bush, not onto the fixing bush shaft.

36

Refit the shower arm and secure it to the wall using the screws provided (if suitable).

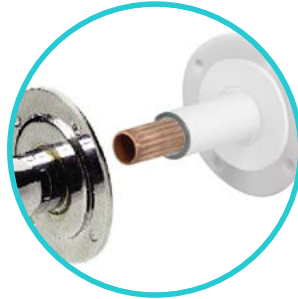

37

Fit the fixing cover plate.



38

Run the shower for a few seconds to clear any debris that may be present.



Refer to point 60 of commissioning instructions.

39

Ensuring the rubber washer is in the correct position, attach the showerhead to the fixed arm and carefully secure using a suitable spanner, or a tool with smooth jaws, sufficiently to lock the head into position.



CEILING MOUNTED FIXED HEAD



The ceiling mounted fixed head is supplied with screws for fixing the product to a noggin. A NOGGIN MUST BE USED AS PART OF THIS INSTALLATION.

40

Run a 15mm outlet pipe from the outlet B of the diverter box to the preferred position for the fixed head.

41

Locate the position for the fixed head in the bathroom and firstly drill a pilot hole to mark the position before checking that there is suitable space behind the ceiling for the fixing assembly.



The minimum height required behind the ceiling is 50mm and the space must allow for an 80mm wide, 50mm deep noggin to be used to support the assembly.

42

Drill a hole (minimum $\varnothing 28\text{mm}$, maximum $\varnothing 40\text{mm}$) through the ceiling and the noggin.

43

Remove the fixing bracket carefully from the fixed head arm.

44

Set the fixing bracket into position and mark the fixing points. Remove the bracket and drill and prepare suitable fixings. Refit the fixing bracket and secure it through the ceiling and into the noggin using the screws provided (if suitable).



45

Feed the arm through the fixing bracket to the correct depth. Tighten the nut using a 32mm spanner if necessary to facilitate.



46

Cut off the excess pipe allowing for a suitable working length to allow for the required 22mm connection. If a push fit connector is to be used then the pipe must be abraded to remove all chrome plating.

47

Connect the pipe work from the Quartz™ smart valve or diverter to the end of the fixed head pipe using a suitable coupling.



Run the shower for a few seconds to clear any debris and to check for any leaks.

48

Lubricate the 'O' ring if necessary and carefully slide the cover plate back over the fixed head arm and into position against the ceiling.

Secure the cover plate to the arm using the grub screw and 2.5mm hexagonal key provided.



49

Ensuring the rubber washer is in the correct position, attach the shower head to the fixed arm and carefully secure using a suitable spanner, or a tool with smooth jaws, sufficiently to lock the head into position.



Refer to point 60 of commissioning instructions.

BATH OVERFLOW FILLER



The bath overflow filler is suitable for baths up to a maximum thickness of 24mm.

50

Carefully unscrew and remove the overflow filler outlet from the body assembly and set aside.



51

Carefully unscrew and remove the bath waste clicker assembly from the waste body and set aside.



52

Offer the bath waste into position ensuring the rubber washer is correctly aligned between the waste assembly and the bath base.



53

Ensuring the rubber washer is correctly aligned, pass the bath waste clicker through the bath and secure to the waste body assembly.



54

Connect the bath waste to a suitable waste pipe.

55

Offer the outlet body assembly into position at the rear of the bath ensuring the rubber washer is correct aligned between the outlet body assembly and bath wall.



56

Ensuring the rubber washer is correctly aligned, pass the overflow filler outlet through the bath and secure to the body assembly.



57

Remove the relevant inlet blanking plug and attach the flexible hose to the blended inlet connection.



58

Connect the flexible hose to the blended supply pipe ensuring suitable non restrictive double check valves are fitted in line with current Water Supply Regulations (not supplied).

59

Once the Quartz™ smart valve and diverter (if applicable) are fully installed, continue to commissioning instructions below.

COMMISSIONING

60

When power is applied to the Q™ smart valve, the controller will display the following message, PREPARING HOLD LEVER TO SKIP wait for the message to clear before commencing commissioning.

61

Pipework for all outlets must be flushed through for at least 15 seconds to clear any debris before fitting any handsets or heads, (refer to the quick start guide for basic operation.

62

Configuring outlets for a Divert model

If you are installing a Divert model, the icons that will appear on the User Interface are:

Outlet A  this will be the Primary outlet

Outlet B 

To change these icons, or to redefine the primary outlet, wake up the Q™ controller and navigate to SETTINGS>CONFIGURE OUTLETS. Then follow the on-screen instructions.

Setting up for Bath models

If you have installed a Q™ shower with a bathfill, the Q™ controller can offer specific bath functionality (storing bath depths). To enable this you must first wake up the Q™ controller and navigate to SETTINGS>CONFIGURE OUTLETS. You must then select the BATH icon to enable the bath functionality.



Helpful tip...

Refer to user guide for further information on the above.

63

WATER SAVE MODE

This feature allows the user to save water. When the shower is on, if the user moves away from it, (eg to shampoo hair), the water flow will reduce to Min. The flow will automatically return to the users preference, when they return to within 0.5m of the Q™ controller.



This function is not suitable for use with Combi systems.

It is switched off by default. To switch it on navigate to SETTINGS>WATER SAVE MODE, and select ON.



Helpful tip...

Refer to user guide for further information.

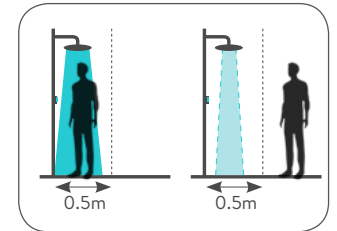

Factory Settings

Warm Up Mode	OFF	(This feature is only available with Q Edition)
Water Save Mode	OFF	
Cleaning Mode	OFF	
Auto Repeat Shower	OFF	
Auto Save Shower	ON	
Run Both Outlets At Warm Up	OFF	
Water Off At End Of Timer	OFF	

CLEANING & MAINTENANCE

Refer to user guide for cleaning advice.

TROUBLE SHOOTING GUIDE

SYMPTOM	POSSIBLE CAUSE	ACTION
Water output is either all hot or all cold, or cold only	Reverse inlet supplies	Check that the supplies correspond with the inlet markings
Water output is not hot enough	The temperature of the hot water cylinder is too low	The cylinder temperature should be at least 15°C hotter than the blend
	Water flow through the hot water appliance is too fast	Check the flow rate recommendations with the heater manufacturer. If fitted to a combination boiler adjust the flow control knob on the mixer valve to reduce flow until a comfortable showering or bathing temperature is achieved
Flow rate is poor and water temperature is low	Unbalanced supplies	Check both sources are equal pressures
	Airlock in the hot water supply (gravity or pumped systems only)	Check the pipework is laid out in accordance with correct practices, paying particular attention to potential air-traps
Water temperature swings regularly between hot and cold	Cold water pressure is too high	If the static water pressure exceeds 10 bar, install a pressure reducing valve (PRV) in accordance with the installation guide
Poor flow rate	Twisted hose Debris in shower head Debris in filters	Check for debris and clear as necessary

NOTES

AQUALISA

Aqualisa Products Limited
The Flyers Way
Westerham Kent TN16 1DE
Customer Services: 01959 560010
Warranty registration: 0800 408 4243
Brochure hotline: 0800 652 3669
Website: www.aqualisa.co.uk
Live Chat at aqualisa.co.uk
Email: enquiries@aqualisa.co.uk

Republic of Ireland
Sales enquiries: 01-864-3363
Service enquiries: 01-844-3212

Follow us on:



Please note that calls may be recorded for training and quality purposes.

The company reserves the right to alter, change or modify the product specifications without prior warning.

© Registered Trademark Aqualisa Products Limited.



Did you know we offer free installer training?

- Locations across the UK
- Expert installation advice
- Deals on the day

Book your place!

**aqualisa.co.uk/training
01959 560042**