

**AQUALISA**

# Dream<sup>TM</sup> DCV

**Thermostatic Dual control mixer  
valve range**

---

Installation guide



Introduction	p.3
- Safety information	p.3
- Product specification	p.3
Connection to supplies	p.4
- Pipe sizing	p.4
- Flushing	p.4
- Filters	p.4
- Isolating valves	p.4
- Pressures	p.5
Boosted gravity system	p.5
- Pump installation	p.5
- Stored water capacities	p.6
Combination boiler systems	p.6
Balanced high pressure systems	p.6
Typical water systems	p.7
System components	p.9
Valve installation instructions	p.11
- Dream Dual Control Valve (DCV)	p.11
Shower head installation	p.15
- Adjustable height Harmony head	p.15
- Wall mount drencher head	p.18
- Bath overflow filler	p.19
- Waste pipe extension kit	p.21
User guide	p.21
- Shower valve	p.21
- Adjustable height Harmony head	p.22
- Wall mount drencher head	p.22
Cleaning & maintenance	p.22
Commissioning	p.23
Cartridge replacement	P.24
Trouble shooting guide	p.26
Notes	p.27

### Introduction

The Dream DCV concealed shower range is available as a single outlet product with either an adjustable or wall drencher head or as a Divert shower solution complete with adjustable head and wall drencher head or bath fill. Dream DCV valves feature separate flow and temperature controls. Dream DCV thermostatic valves provide close temperature stability and fail safe protection on appropriate high pressure systems. Please refer to the product specification section below.

If at any stage during installation you have any questions, please contact the Aqualisa customer helpline on 01959 560010 for assistance.

### Safety information

This product must be installed by a competent person in accordance with all relevant current Water Supply Regulations.

#### **THE SHOWER MUST NOT BE USED WITH A HOT WATER SUPPLY TEMPERATURE OVER 65 C.**

The Dream DCV range is designed for domestic use only.

### Product specification

Dream DCV products are suitable for all boosted gravity, balanced high pressure and combination boiler systems\*. Pressure range 1bar – 5bar max (static).

\*The combination boiler MUST have a minimum rating of 24kW (80000 Btu) and be of the type fitted with a fully modulating gas valve.

**If in any doubt, please contact the appliance manufacturer before installation commences.**

When fitted to combination boiler systems, Dream DCV shower valves have been designed to give optimum temperature control and stability from fully modulating combination boilers and instantaneous gas water heaters.

## Connections

Dream DCV products are designed for conventional supplies with HOT on the left and COLD on the right as viewed from the front.

Dream DCV shower valves are supplied with  $\frac{3}{4}$  inch BSP threads.

Supply lines must be flushed clear of any debris before installation of the unit. Any debris accumulation in the shower valve and head may result in damage and poor performance.

## Pipe sizing

Long pipe runs, on both inlet and outlet, will reduce the flow rate at the shower head. If long pipe runs are unavoidable, use copper pipe rather than plastic. If plastic pipe is used, minimise the number of elbows as pipe inserts are very restrictive. Consideration should be given to using 22mm plastic or copper pipe especially if a diverter valve is to be fitted.

## Flushing

Some modern fluxes can be extremely corrosive and, if left in contact, will attack the working parts of the unit. All soldering must be completed and the pipe work thoroughly flushed out in accordance with current Water Supply Regulations prior to connection of the product.

## Filters

To ensure ongoing optimum performance, Dream DCV products are protected by inlet filter assemblies in the internal waterways. Debris accumulation may result in reduced flow from the shower head and noisy operation.

As this condition is not covered by our standard warranty terms, it is suggested that the filters be removed and checked by a competent person. In the event of any difficulties please contact the Aqualisa customer helpline for assistance.

## Isolating valves

Suitable full way isolation valves must be fitted to both supplies in accordance with current Water Supply Regulations and our terms of warranty.

Due to their restrictive characteristics, stopcocks and ball type valves that reduce the pipe bore size must not be used on gravity and boosted gravity installations.

## Pressures

The Dream DCV cartridge is designed to operate from the mains at a maximum of 5bar. If the mains pressure is likely to exceed 5bar, a 'drop tight' PRV must be fitted on the supply pipe after the main stopcock. A setting of 3bar is recommended. It should be noted that daytime pressures approaching 5bar can rise above the stated maximum overnight.

A suitable PRV is available from Aqualisa.

**Dream DCV products are not suitable for mixed supply systems, e.g. gravity hot and mains cold.**

## Boosted gravity fed hot and cold supplies

Services must be installed according to good plumbing practice having regard to pipe sizing, long pipe runs and low head situations.

The cold supply for the valve assembly must be taken directly from the cold water storage system. The hot supply may be taken from the vent/draw off pipe of the hot water cylinder at a point below the cylinder connection or alternatively from the underside of the horizontal draw off.

Rising pipe work must NOT be connected into the horizontal draw off from the cylinder or to any point in the vent/draw off pipe above the cylinder connection.

## **CYLINDER TEMPERATURE IN EXCESS OF 65°C MAY RESULT IN POOR SHOWER PERFORMANCE**

To minimise pressure loss we recommend that the hot and cold supplies are run in 22mm to the mixing valve.

## Pump installation

### **UNDER NO CIRCUMSTANCES MUST A PUMP BE FITTED DIRECTLY TO THE WATER MAIN**

A pump must only be used to boost the pressure from tank fed supplies.

A minimum 1 bar twin ended booster pump is recommended.

### **ENSURE THE MINIMUM GRAVITY FLOW RATE IS SUFFICIENT TO OPERATE THE PUMP FLOW SWITCHES.**

### **PLEASE REFER TO THE MANUFACTURERS PUMP INSTALLATION GUIDE FOR PUMP INSTALLATION INFORMATION.**

Please refer to the typical system layout on page 7.

## **Stored water capacities**

The minimum capacity of the cold storage cistern should be not less than 225 litres (50 gallons). The capacity of the hot cylinder must be capable of meeting the anticipated demand.

## **Combination boiler/multipoint system**

Dream DCV products are suitable for use with combination boiler systems. The combination boiler **MUST** have a minimum rating of 24kW (80,000 Btu) and be of the type fitted with a fully modulating gas valve. This is sufficient to operate one outlet at a time.

**If in any doubt, please contact the appliance manufacturer before installation commences.**

The cold supply can be taken from the nearest convenient mains supply and the hot supply can be taken from the nearest hot water draw off point. Account must be taken of the pressure drops that will occur when other draw off points are used while the shower is in use.

Please refer to the typical system layout on page 7.

When fitted to combination boiler systems, Dream DCV shower valves have been specifically designed to give optimum temperature control and stability from fully modulating combination boilers and instantaneous gas water heaters.

## **Balanced high pressure system**

The cold water supply must be drawn from the same mains supply as that to the hot water system (downstream of the cylinder manufacturer's pressure limiting valve, where supplied) and the hot supply from the nearest convenient draw off point. Account must be taken of pressure drops that may occur when other draw off points are used while the shower is in use.

Please refer to the typical system layout on page 8.

# Typical system diagrams

## Typical pumped system installation

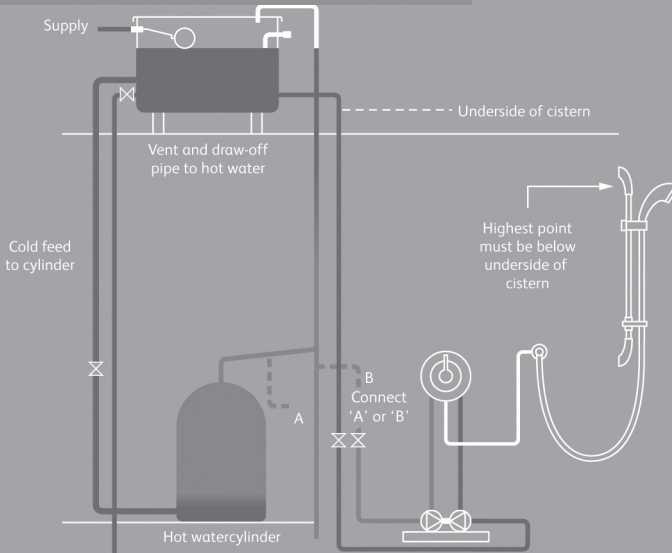

## Typical combination boiler system installation

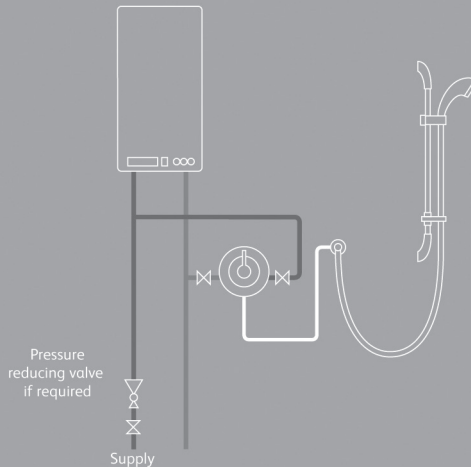

## Typical UHW system installation

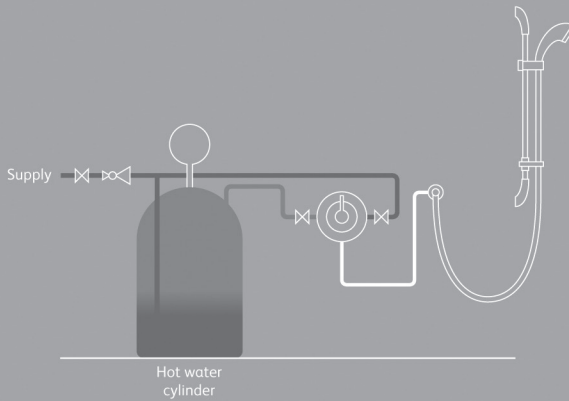

## Typical thermal storage unit system installation

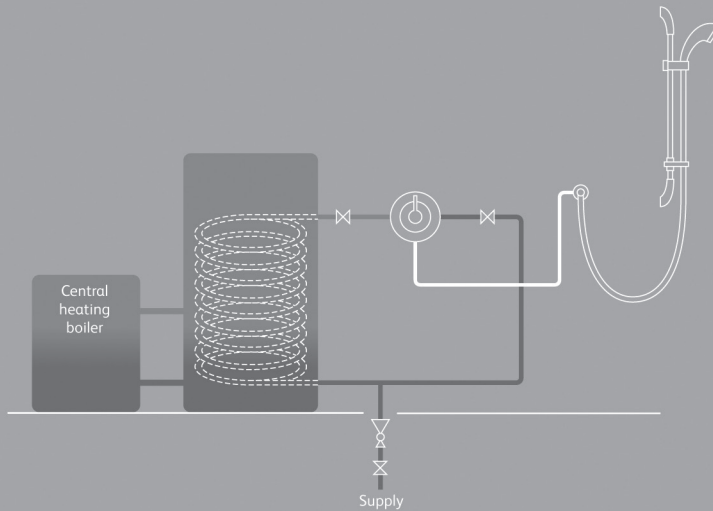



## Components - Dream DCV with adjustable head

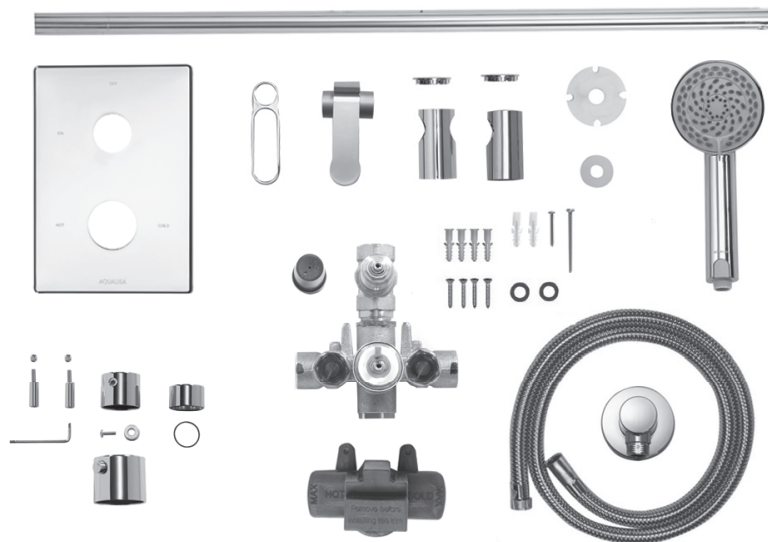

## Components - Dream DCV with wall drencher head

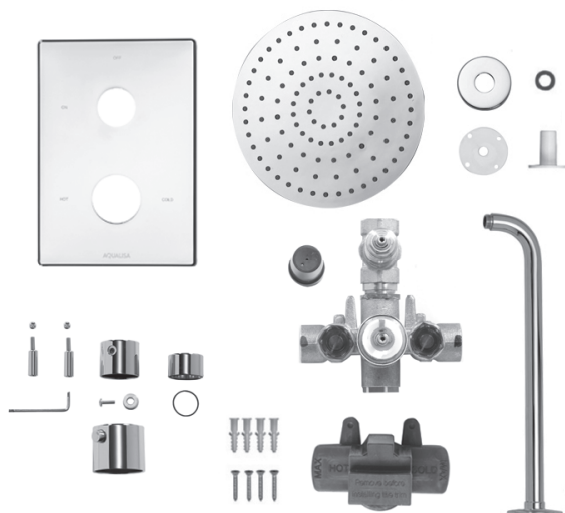

## Components - Dream DCV Divert with adjustable and wall drencher heads

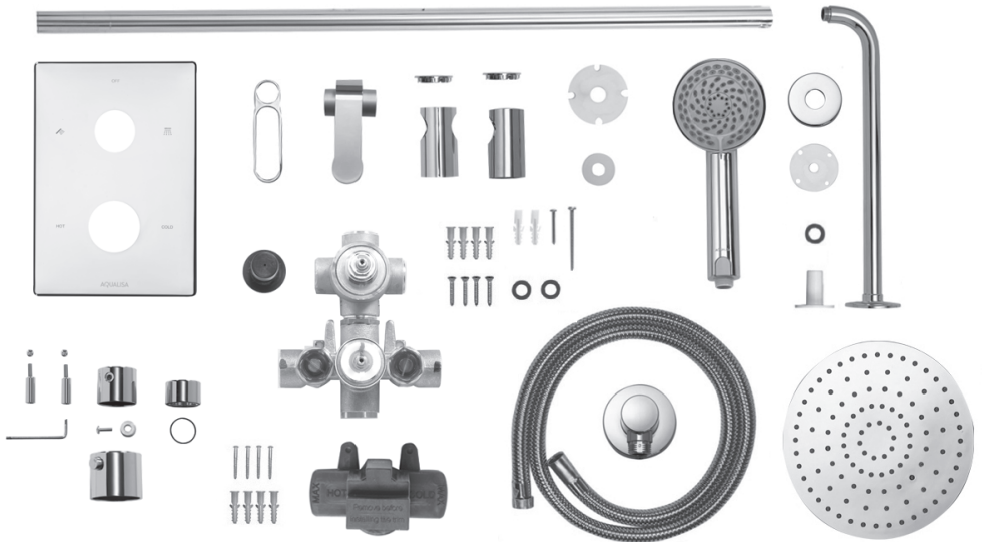

## Components - Dream DCV Divert with adjustable head and bath overflow filler

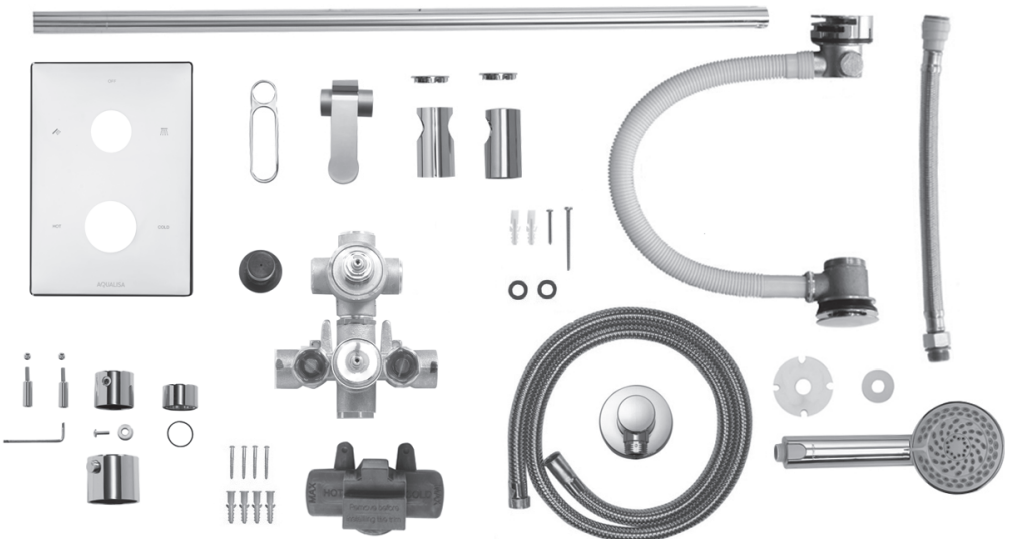

## Dream DCV valve installation

**!** In addition to the guide below it is essential that the Important information section is read and understood and that you have all the necessary components (shown on page 9 or 10) before commencing installation. Failure to install the product in accordance with these instructions may adversely affect the warranty terms and conditions. Do not undertake any part of this installation unless you are competent to do so. Prior to starting, ensure that you are familiar with the necessary plumbing regulations required to install the product correctly and safely.

**1** If installing the product into a solid wall, chase out a suitable recess in the wall to receive the valve and pipework. If installing the valve in a concealed panel mounted situation, in most cases it will be necessary to first install a suitable sound fixing in the cavity area before fixing the valve.

A hole of 117mm wide x 135mm high is required to enable removal of the mortar guard and to allow for any future maintenance of the valve.

The valve needs to be mounted to the depth shown opposite. The distance between the  $\frac{3}{4}$  inch inlet pipe connections is 140mm.

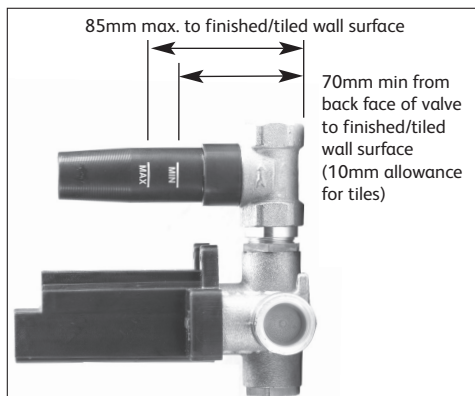

**2** Remove the mortar guards from the valve assembly and set aside.



**3** Prepare suitable 22mm inlet pipe work ending in suitable  $\frac{3}{4}$  inch BSP connections and construct a suitable 15mm outlet supply pipe to the desired location for the wall outlet, fixed head or bath overflow outlet.

**!** For divert valves, the top outlet feeds to the fixed head and the side outlet feeds to the adjustable kit wall outlet or bath overflow filler.

**4** Place the valve into the required position within the wall and mark and prepare the fixing points.

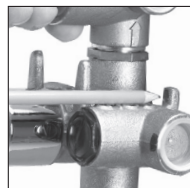

**5** Secure the valve to the wall using suitable fixing screws.

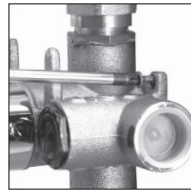

**6** Secure the pipe work to the valve inlets using a suitable tool.

**!** Pipework connections are not supplied, suitable 3/4 inch BSP unions/connection fittings are required.

**7** The valve can now be checked for leaks by rotating the flow control knob, ensuring the flow can discharge safely to waste. If all is sound, turn the valve off.

**8** Refit the mortar guards to the valve assembly and fill in the chase. Suitable non-setting infill material such as paper, polystyrene etc. should be wrapped around the components and a plaster finish applied. Once the infilling material has set, carefully remove the mortar guards to expose the valve body.

**!** THE MORTAR GUARDS MUST BE USED

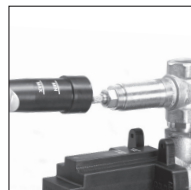

**9** Using a silicone based lubricant or liquid soap, lubricate the wall plate seal within the round cut out of the wall plate. Remove the double sided tape on the rear of the wall plate and carefully push the wall plate into position flush with the finished wall surface.



**10** Screw the adapter sleeve into position on the top on/off flow control spindle, ensuring the black O-ring is correctly aligned in the groove on the back of the adapter.

**!** A small amount of petroleum jelly (Vaseline or similar) can be used to hold the O-ring in place whilst screwing the adapter into position.

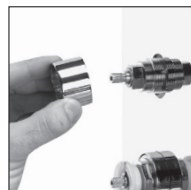

**11** Secure the brass spindle adapter into position using the brass screw provided.

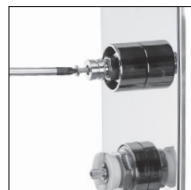
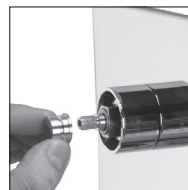

- 12** Place the top on/off flow control knob into position and tighten the grub screw using the hexagonal key provided.

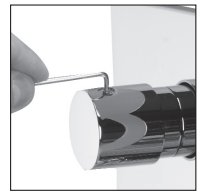
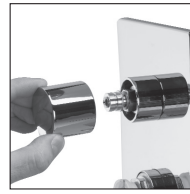

**!** The on/off flow control / Divert knobs can be fitted with or without the levers. If not using the levers, the hexagonal fixing points can be concealed using the blanking caps provided. N.B. We recommend these are placed on the underside of the control knobs.

If using the levers, please follow the instructions below.

- 13** Secure the lever grub screw to the on/off flow control knob using the hexagonal key provided.

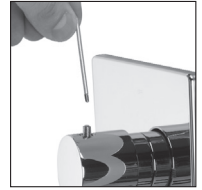

- 14** Secure the on/off flow control lever to the control knob.

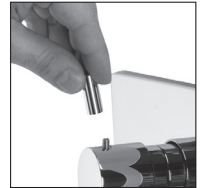

- 15** Ensure the markings on the temperature brass spindle and the white plastic temperature stop ring align at the 12 o'clock position.



- 16** Place the temperature control knob into position with the temperature stop button at the 12 o'clock position.

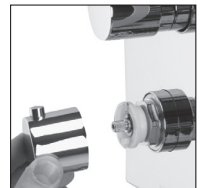

- 17** Tighten the temperature control knob grub screw using the hexagonal key provided.

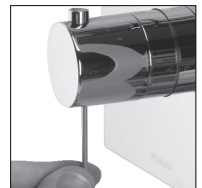

18

If the lever is not to be fitted, place the temperature control screw cover into position and carefully push into place.

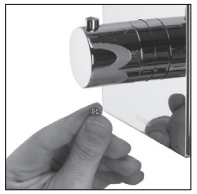

19

If fitting the lever, secure the lever grub screw to the temperature control knob using the hexagonal key provided.



20

Secure the temperature lever to the control knob.

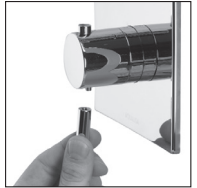

Please refer to pages 15 to 20 for adjustable height head, wall mount fixed head or bath overflow filler installation instructions.

### Adjustable height head installation

**1** Prepare pipework from the shower valve to the required position for the hose outlet using a Ø15mm copper pipe. Slide the wall spacer down the projecting pipe flush with the finished wall surface.

**2** Slide the 15mm gripper ring down the projecting pipe flush with the wall spacer fitting.

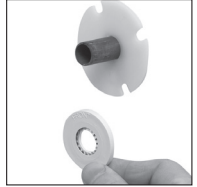

**3** Trim the projecting pipe to a length of 15-22mm using a rotary type cutter. If a hacksaw is used, the pipe end must be carefully de-burred and chamfered.

**4** Clean and lubricate the pipe using a suitable (silicone based) lubricant.

**5** Remove the locking screw, rotate the chrome outlet assembly and remove the outlet from the wall mounting plate.



**6** Place the wall outlet mounting plate onto the pipe assembly and mark and prepare the fixing points, using the fixings provided, if suitable.

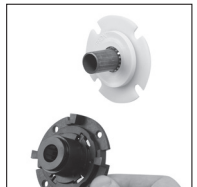

**7** Ensuring the locking screw hole is positioned at the bottom; secure the wall mounting plate to the wall using the screws provided, if suitable.

**8** Ensuring the O-ring is in the correct position on the recess of the spigot section on the mounting plate, place the wall outlet onto the mounting plate in the 5 o'clock position and rotate clockwise until a stop is reached.

**9** Refit the locking screw taking care not to over tighten



**10** Drill and prepare two fixing points between 520mm (minimum) and 830mm (maximum) apart using the fixings provided, if suitable.

**!** The top rail end bracket can be adjusted to suit existing screw holes in the finished wall by sliding the bracket up or down the rail to suit the required position.



**11** Pass the rail through the handset holder while keeping the slider levers depressed.



**12** Carefully slide the gel hook onto the rail under the handset holder.

**!** Current Water Supply regulations state that the handset should not be allowed to pass a point 25mm above the spill over level of the bath or shower tray. If this cannot be achieved, the hose must be passed through the gel hook which has been designed to be utilised as a hose restraint.

**13** Secure the top rail bracket into position using the screws provided, if suitable.



**14** Attach the bottom rail end body onto the rail.



**15** Slide the rail assembly up through the top rail end body.



**16** Align the small hole in the rail with the bottom rail end fixing point. Secure the rail assembly to the wall, using the fixings provided, if suitable, taking care to not over tighten.

**17** Place the rail end caps into the rail ends and push firmly into position.



**18** Pass the hose through the gel hanger.



**19** Ensuring the hose washer is in the correct position, secure the handset to the hose by pressing and holding the anti-swivel locking button on the handset whilst securing the handset to the hose, then place the handset into the handset holder.



**20** Ensuring the hose washer is in the correct position; attach the hose to the wall outlet.



## Wall mount drencher head installation

**1** Prepare pipework from the shower valve to the required position for the fixed shower head using  $\varnothing 15\text{mm}$  copper pipe. Cut the outlet pipe to a finished length (55mm – 150mm measured from the finished wall surface) using a rotary type cutter. If a hacksaw is used, the pipe end must be carefully de-burred and chamfered.

**2** Slide the wall spacer down the projecting pipe flush with the finished wall surface.



**3** Ensure the pipe is clean and free of dust and slide the fixing bush which incorporates the 15mm gripper ring down the projecting pipe flush with the wall spacer.



**4** Carefully remove the fixed head arm and drill and prepare the fixings using the fixings provided, if suitable, taking care to avoid pipework hidden in the wall.

**5** Ensuring the fixing bush is clean and free of dust, fit the 15mm O-ring against the end of the fixing bush. Lubricate the O-ring using a suitable silicone based lubricant.

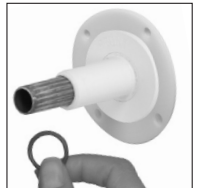

**!** The O-ring must be positioned on the 15mm pipe flush to the fixing bush, not onto the fixing bush shaft.

**6** Refit the shower arm and secure it to the wall using the screws provided.



**7** Run the shower for a few seconds to clear any debris that may be present.

**8** Slide the cover plate into position flush with the finished wall surface.



**9** Ensuring the rubber washer is in the correct position, attach the shower head to the fixed arm and carefully secure using a suitable spanner, or a tool with smooth jaws, sufficiently to lock the head into position.



## Bath overflow filler

**!** The bath overflow filler is suitable for baths up to a maximum thickness of 24mm.

**1** Carefully unscrew and remove the overflow filler outlet from the body assembly and set aside.



**2** Carefully unscrew and remove the bath waste clicker assembly from the waste body and set aside.



**3** Offer the bath waste into position ensuring the rubber washer is correctly aligned between the waste assembly and the bath base.



**4** Ensuring the rubber washer is correctly aligned, pass the bath waste clicker through the bath and secure to the waste body assembly



**5** Connect the bath waste to a suitable waste pipe.

**6** Offer the outlet body assembly into position at the rear of the bath ensuring the rubber washer is correctly aligned between the outlet body assembly and bath wall.



**7** Ensuring the rubber washer is correctly aligned, pass the overflow filler outlet through the bath and secure to the body assembly.



**8** Remove the relevant inlet blanking plug and attach the flexible hose to the blended inlet connection.



**9** Connect the flexible hose to the blended supply pipe ensuring suitable non-restrictive double check valves are fitted in line with current Water Supply Regulations (not supplied).

## Waste pipe extension kit

**!** If required, for larger baths, a 900mm waste pipe conversion kit is available from Aqualisa Customer Service department. Please contact our Customer Service Department on 01959 560010.

**1** Unscrew the clamping nut and remove the waste pipe from the waste assembly.



**2** Remove the clamping nut and sealing washer from the waste pipe and set aside.

**3** Carefully pull the waste pipe away from the outlet assembly.

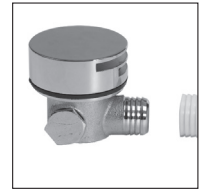

**4** Reassemble the unit using the longer waste pipe by reversing the above procedure.

## Shower valve user guide

### Flow control - Single outlet valves

1. The lever in the 12 o'clock position indicates the valve is fully closed. When the lever is in the 9 o'clock position, the valve is fully open.
2. Turn the flow control lever anti-clockwise to turn the shower on. The more the lever is turned, the more water flow is delivered.
3. Turn the flow control lever clockwise into the closed position after use.

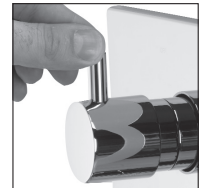

### Flow control - Divert valves

1. The lever in the 12 o'clock position indicates the valve is fully closed. When the lever is in the 9 o'clock position, the adjustable head outlet is fully open. When the lever is in the 3 o'clock position, the drencher head or bath fill is fully open.
2. Turn the flow control lever clockwise or anti-clockwise to turn the desired shower outlet on. The more the lever is turned, the more water flow is delivered.
3. Turn the flow control lever clockwise into the closed position after use.



**N.B. Both shower heads/bath CANNOT be used simultaneously.**

## Temperature control – Single outlet and Divert valves

1. Rotate the temperature control lever to select a comfortable showering temperature, using the temperature markings as a guide.

**! The temperature stop button should be pressed to allow for a warmer setting.**



## Adjustable height Harmony head user guide

1. Rotate the sprayplate lever clockwise or anti-clockwise to select the desired spray pattern.

**N.B. When the lever is in the 3 o'clock position when viewed from below, the water saving mode is selected. This provides the same spray pattern as position 3, but, depending on which water system the product is fitted to, offers up to 25% water saving.**



2. To select the preferred height for the shower head, depress the levers fully to enable the holder to be moved up or down the rail.



3. Angular adjustment is made by carefully but firmly pulling forwards or pushing back the shower head against the knuckle ratchet in the holder.

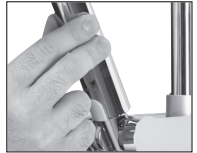

## Fixed head user guide

1. The angle of the fixed shower head can be adjusted. The shower head is mounted on a multi directional ball joint to allow for angular adjustment in any direction by carefully holding the shower head and moving the head to the desired angle.



## Cleaning and maintenance

Your Aqualisa shower system should be cleaned using only a soft cloth and washing up liquid.

### **DO NOT USE ABRASIVE CLEANERS.**

To reduce the need for chemical descaling in hard water areas, your shower head incorporates a 'clear flow' system, whereby any scale build up can be broken down by gently rubbing the flexible tips of the jets during use. This procedure should be completed regularly, as often as once a week in some hard water areas, as scale build up can affect the spray pattern and cause the shower to perform poorly. Failure to descale the shower head can affect the internal seals and may affect the guarantee.

Cleaning and maintenance should not be undertaken by children without supervision by a person responsible for their safety.

Should chemical descaling of the head become necessary, remove the shower head fully and immerse in a mild proprietary descalent.

**IT IS IMPERATIVE THAT DESCALING IS CARRIED OUT IN ACCORDANCE WITH THE MANUFACTURER'S INSTRUCTIONS, SUBSTANCES THAT ARE NOT SUITABLE FOR PLASTICS AND ELECTROPLATED SURFACES MUST NOT BE USED.**

## Dream DCV valve commissioning

The Dream DCV thermostatic valves are factory set to a safe maximum temperature of 46°C. If required, the maximum outlet temperature can be adjusted following the procedure below:

1. Set the temperature lever to the mid blend (temperature stop button at 12 o'clock) position.

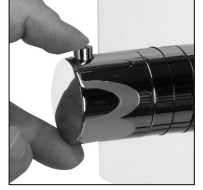

2. Remove the grub screw cover located at the 6 o'clock position.

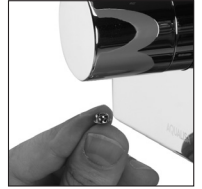

3. Insert the hexagonal key into the temperature control knob and loosen the grub screw.

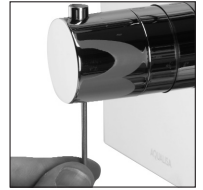

4. With the shower running, push the button in and rotate the control knob to the desired temperature. Turn the shower off.

5. Having rotated the temperature control knob to the desired position, remove the temperature knob from the valve.



6. Place the temperature knob back onto the valve with the push button in the 12 o'clock position.

7. Secure the control knob onto the valve by reversing the removal procedure detailed above.

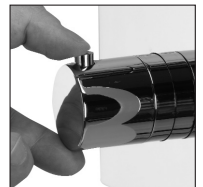

### ! Isolate both hot and cold water supplies.

1. Remove the grub screw cover located at the 6 o'clock position.

**If the lever is fitted onto the bottom of the knob, unscrew the lever and remove the securing grub screw using the hexagonal key provided.**

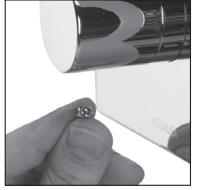

2. Insert the hexagonal key into the temperature control knob and loosen the grub screw. Remove the control knob from the valve and set aside.

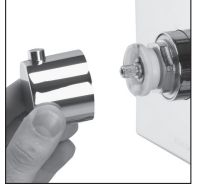
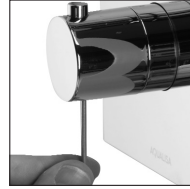

3. Carefully remove the white plastic maximum temperature stop ring from the brass spindle using a small flat bladed screwdriver and set aside.

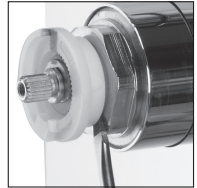

4. Remove the thermostatic cartridge by unscrewing anti-clockwise from the valve, using a 30mm socket or wrench.



5. Screw the new cartridge into the body assembly, and tighten using a 30mm socket or wrench.



6. Adjust the temperature by turning the brass spindle clockwise for a cooler setting or anti-clockwise for a warmer setting.

**!Please note: The factory setting is set to 46°C. This is marked with a red marking on the brass spindle. When the marking is at the 12 o'clock position, the temperature is set to 46°C.**





7. To ensure the temperature stop button activates at the 12 o'clock position, ensure that when the white plastic stop ring is fitted onto the brass spindle, that the red marking on ring is at the 12 o'clock position.

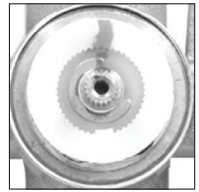
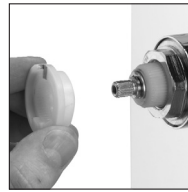

8. Turn the valve on and check the maximum temperature using a digital thermometer. If any adjustment is required, repeat steps 4 and 5 above until the desired maximum temperature has been reached.
9. Place the temperature control knob into position with the temperature stop button at the 12 o'clock position.

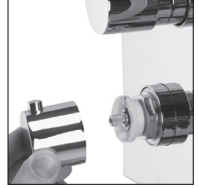

10. Tighten the temperature control knob grub screw using the hexagonal key provided.

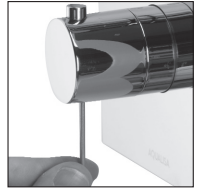

11. Place the temperature control screw cover into position and carefully push into place.

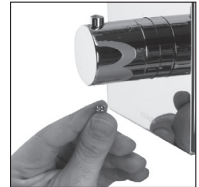

**!Please note: An additional optional lever is supplied for use with the temperature knob, to fit this lever instead of the cover, please follow the instructions below.**

12. Secure the lever grub screw to the temperature control knob using the hexagonal key provided.

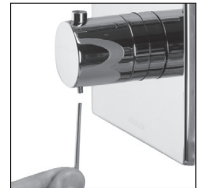

13. Secure the temperature lever to the control knob.

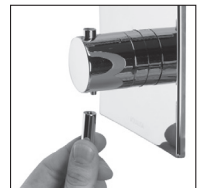

14. Re-instate the hot and cold water supplies. Check the full hot temperature and adjust as necessary.

## Trouble shooting guide

Symptom	Possible cause	Action
Water output is either all hot or all cold, or cold only	Reversed inlet supplies	Check that the supplies correspond with the inlet markings. Contact Customer Services for a reverse inlet cartridge
Water output is not hot enough	The temperature of the hot water cylinder is too low  Water flow through the hot water appliance is too fast  Water flow through the hot water appliance is too fast (combination boiler systems)	The cylinder temperature should be at least 15°C hotter than the blend  Check the flow rate recommendations with the heater manufacturer  Adjust the flow control knob on the mixer valve to reduce flow until a comfortable showering temperature is achieved
Flow rate is poor and water temperature is low	Airlock in the hot water supply	Check that the pipe work is laid out in accordance with correct practices, paying particular attention to potential air-traps
Water temperature swings regularly between hot and cold	Cold water pressure is too high	If the static water pressure exceeds 5 bar, install a pressure reducing valve (PRV) in accordance with the installation guide
Poor flow rate	Twisted hose Debris in shower head Debris in filters	Check for debris and clear as necessary





# AQUALISA

Aqualisa Products Limited  
The Flyer's Way  
Westerham Kent TN16 1DE

Customer helpline: 01959 560010  
Brochure Hotline: 0800 652 3669  
Website: [www.aqualisa.co.uk](http://www.aqualisa.co.uk)  
Email: [enquiries@aqualisa.co.uk](mailto:enquiries@aqualisa.co.uk)

Republic of Ireland  
Sales enquiries: 01-864-3363  
Service enquiries: 01-844-3212



Part No:701142 Issue 01 Jun 14

Please note that calls may be recorded for training and quality purposes

The company reserves the right to alter, change or modify the product specifications without prior warning

TM Trademark of Aqualisa Products Limited