

# AQUALISA

# Colt<sup>®</sup>

Thermostatic mixer shower with adjustable height  
90mm Harmony head.

Thermostatic mixer shower with ceiling mounted  
drencher head.

---

## Installation guide





Introduction	p.4
- Safety information	p.4
- Product specification	p.4
Connection to supplies	p.4
- Pipe sizing	p.4
- Flushing	p.5
- Filters	p.5
- Isolating valves	p.5
- Pressures	p.5
Gravity system	p.5
- Siting	p.6
- Pump installation	p.6
- Stored water capacities	p.6
Combination boiler systems	p.6
Balanced high pressure systems	p.6
Typical water systems	p.7
System components	p.9
Valve installation instructions	p.10
- Colt concealed valve	p.10
- Colt exposed valve	p.13
Shower head installation	p.16
- Adjustable height Harmony head	p.16
- Ceiling mounted fixed head	p.18
User guide - Shower valve	p.19
- Colt concealed valve	p.19
- Colt exposed valve	p.20
User guide - Shower head	p.20
- Adjustable height Harmony head	p.20
- Ceiling mounted fixed head	p.20
Cleaning & maintenance	p.21
Commissioning	p.21
Trouble shooting guide	p.23

## Introduction

The Colt product range includes an exposed or a concealed valve complete with an adjustable height shower head, as well as a concealed valve with a ceiling mounted fixed head. Colt thermostatic valves provide close temperature stability and fail safe protection on appropriate high and low pressure systems. Please refer to the product specification section below.

If at any stage during installation you have any questions, please contact the Aqualisa customer helpline on 01959 560010 for assistance.

## Safety information

This product must be installed by a competent person in accordance with all relevant current Water Supply Regulations.

**THE SHOWER MUST NOT BE USED WITH A HOT WATER SUPPLY TEMPERATURE OVER 65°C.**

The Colt range is designed for domestic use only.

## Product specification

Colt products are suitable for all gravity, boosted gravity, balanced high pressure and combination boiler systems\*. Pressure range 0.1bar – 10bar max (static).

\*The combination boiler MUST have a minimum rating of 24kW (80,000 Btu) and be of the type fitted with a fully modulating gas valve.

A cold inlet flow regulator is provided for use with combination boiler applications.

**If in any doubt, please contact the appliance manufacturer before installation commences.**

## Connections

Colt products are designed for conventional supplies with HOT on the left and COLD on the right as viewed from the front.

Colt shower valves incorporate 'push fit' type connections for use with 15mm British standard copper tube. Tube should be cut using a rotary type cutter and lubricated using a silicone based lubricant or petroleum jelly (Vaseline or similar) prior to insertion into the fitting.

If plastic pipe is used, the tube insert must not increase the tube diameter or extend the cut off length by more than 2mm.

**THESE FITTINGS ARE NOT SUITABLE FOR STAINLESS STEEL TUBE.**

Supply lines must be flushed clear of any debris before installation of the unit. Any debris accumulation in the shower valve and head may result in damage and poor performance.

## Pipe sizing

Long pipe runs, on both inlet and outlet, will reduce the flow rate at the shower head. If long pipe runs are unavoidable, use copper pipe rather than plastic. If plastic pipe is used, minimise the number of elbows as pipe inserts are very restrictive. Consideration should be given to using 22mm plastic or copper pipe especially if a diverter valve is to be fitted.

## Flushing

Some modern fluxes can be extremely corrosive and, if left in contact, will attack the working parts of the unit. All soldering must be completed and the pipe work thoroughly flushed out in accordance with current Water Supply Regulations prior to connection of the product.

## Filters

To ensure ongoing optimum performance, the internal control mechanism 'cartridge' is protected by a two-part filter system. Debris accumulation may result in reduced flow from the shower head and noisy operation.

As this condition is not covered by our standard warranty terms, it is suggested that the cartridge be removed and the filters checked by a competent person. In the event of any difficulties please contact the Aqualisa customer helpline for assistance.

## Isolating valves

Suitable full way isolation valves must be fitted to both supplies in accordance with current Water Supply Regulations and our terms of warranty.

Due to their restrictive characteristics, stopcocks and ball type valves that reduce the pipe bore size must not be used on gravity and boosted gravity installations.

## Pressures

The Colt cartridge is designed to operate from the mains at a maximum of 10bar. If the mains pressure is likely to exceed 10bar, a 'drop tight' PRV must be fitted on the supply pipe after the main stopcock. A setting of 3bar is recommended. It should be noted that daytime pressures approaching 8bar can rise above the stated maximum overnight.

A suitable PRV is available from Aqualisa.

**Colt products are not suitable for mixed supply systems, e.g. gravity hot and mains cold.**

## Gravity fed hot and cold supplies

Services must be installed according to good plumbing practice having regard to pipe sizing, long pipe runs and low head situations.

The cold supply for the valve assembly must be taken directly from the cold water storage system. The hot supply may be taken from the vent/draw off pipe of the hot water cylinder at a point below the cylinder connection or alternatively from the underside of the horizontal draw off.

Rising pipe work must NOT be connected into the horizontal draw off from the cylinder or to any point in the vent/draw off pipe above the cylinder connection.

### **CYLINDER TEMPERATURE IN EXCESS OF 65°C MAY RESULT IN POOR SHOWER PERFORMANCE**

To minimise pressure loss we recommend that the hot and cold supplies are run in 22mm as close as reasonably possible to the mixing valve before reducing to 15mm.

## Siting

For optimum performance, with gravity fed systems the distance between the bottom of the storage cistern and the shower head should be not less than 1m (when using an adjustable height head). If using a fixed head, the highest point of the pipe work must be below the underside of the cistern.

Please refer to the typical system layout on page 7.

## Pump installation

### **UNDER NO CIRCUMSTANCES MUST A PUMP BE FITTED DIRECTLY TO THE WATER MAIN**

A pump must only be used to boost the pressure from tank fed supplies.

A minimum 1 bar twin ended booster pump is recommended.

### **ENSURE THE MINIMUM GRAVITY FLOW RATE IS SUFFICIENT TO OPERATE THE PUMP FLOW SWITCHES.**

### **PLEASE REFER TO THE MANUFACTURERS PUMP INSTALLATION GUIDE FOR PUMP INSTALLATION INFORMATION.**

Please refer to the typical system layout on page 7.

## Stored water capacities

The minimum capacity of the cold storage cistern should be not less than 225 litres (50 gallons). The capacity of the hot cylinder must be capable of meeting the anticipated demand.

## Combination boiler/multipoint system

Colt products are suitable for use with combination boiler systems. The combination boiler **MUST** have a minimum rating of 24kW (80,000 Btu) and be of the type fitted with a fully modulating gas valve. This is sufficient to operate one outlet at a time.

**If in any doubt, please contact the appliance manufacturer before installation commences.**

The cold supply can be taken from the nearest convenient mains supply and the hot supply can be taken from the nearest hot water draw off point. Account must be taken of the pressure drops that will occur when other draw off points are used while the shower is in use.

Please refer to the typical system layout on page 8.

## Balanced high pressure system

The cold water supply must be drawn from the same mains supply as that to the hot water system (down stream of the cylinder manufacturer's pressure limiting valve, where supplied) and the hot supply from the nearest convenient draw off point. Account must be taken of pressure drops that may occur when other draw off points are used while the shower is in use.

Please refer to the typical system layout on page 8.

# Typical system diagrams

## Typical gravity system installation

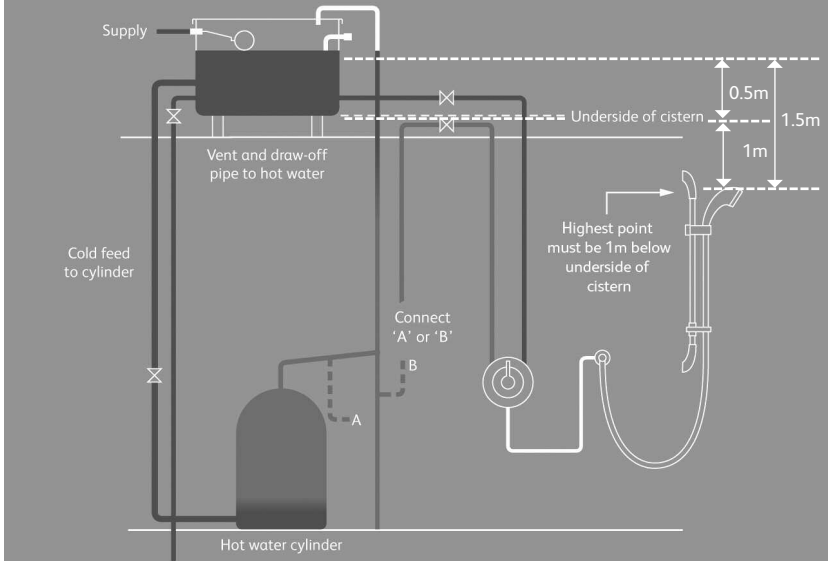

## Typical pumped system installation

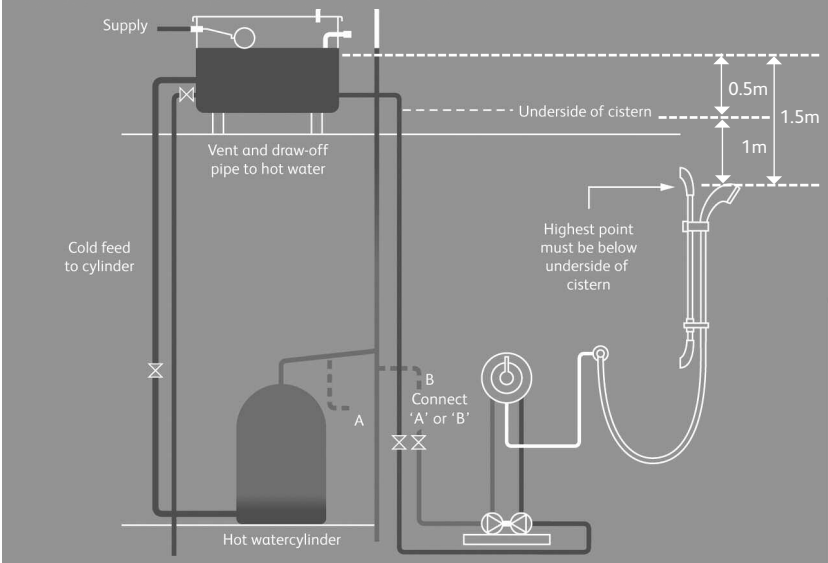

# Typical system diagrams continued

## Typical combination boiler system installation

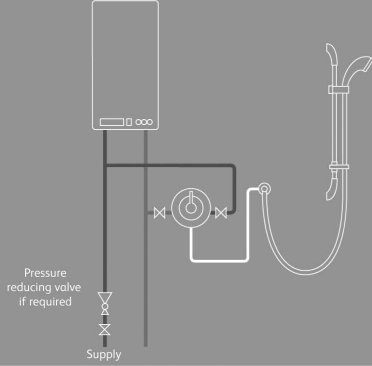

## Typical UHW system installation

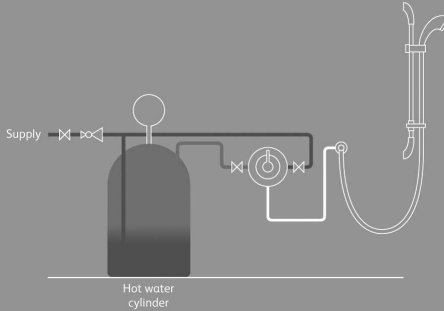

## Typical thermal storage unit system installation

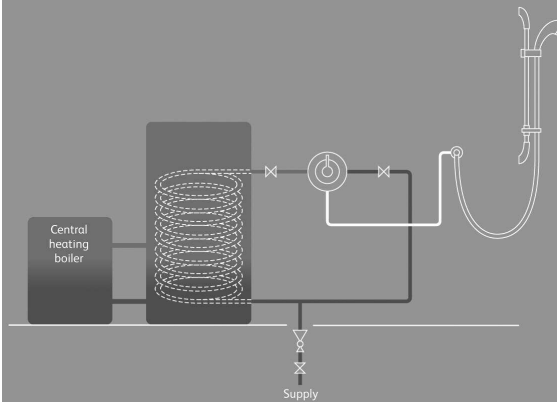



## Components - Colt exposed with adjustable height Harmony head



Exposed shower valve with adjustable height Harmony head

## Components - Colt concealed with adjustable height Harmony head

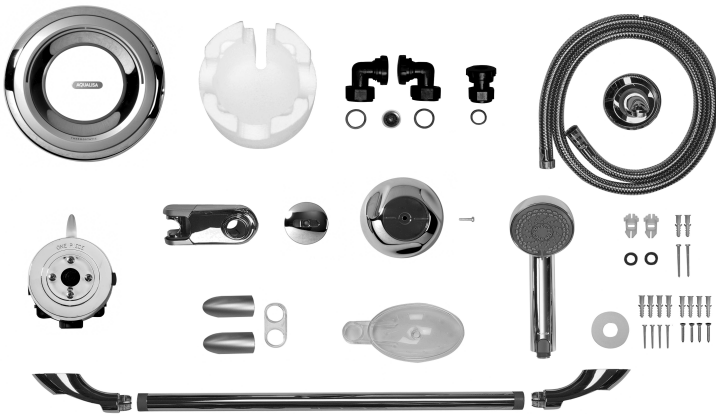

Concealed shower valve with adjustable height Harmony head

## Components - Colt concealed with 220mm fixed head

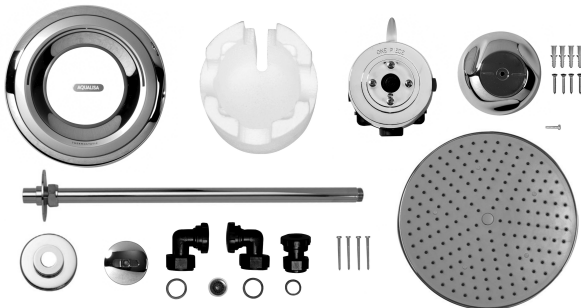

Concealed shower valve with fixed 220mm head

## Colt concealed valve installation

**!** In addition to the guide below it is essential that the written instructions overleaf are read and understood and that you have all the necessary components (shown on page 9) before commencing installation. Failure to install the product in accordance with these instructions may adversely affect the warranty terms and conditions. Do not undertake any part of this installation unless you are competent to do so. Prior to starting ensure that you are familiar with the necessary plumbing regulations required to install the product correctly and safely.

Colt concealed is supplied with universal fixings.

- 1** If installing the product built in to a solid wall, chase out a suitable recess in the wall to receive the valve and pipe work. If installing the valve in a concealed panel mounted situation, in most cases it will be necessary to first install a suitable sound fixing in the cavity area before fixing the valve. A hole of  $\text{Ø}130\text{mm}$  is required to install the valve and gain access to inlet and outlet connectors.

The valve needs to be mounted to the depth shown at the following centres.

The distance between the 15mm inlet centre pipe centres is 150mm as shown.

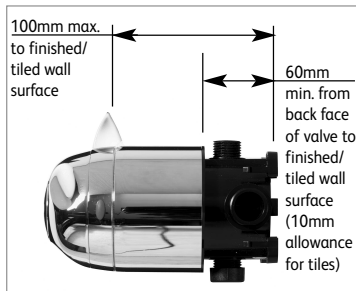
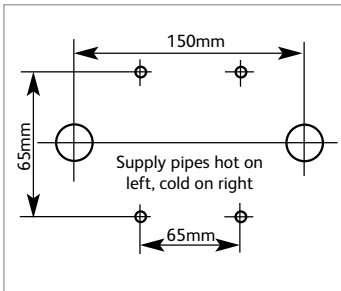

- 2** Mark the position for the four fixing points as outlined above.

- 3** Carefully remove the valve from its packaging and retain the mortar guard for later use.

- 4** Set the temperature control lever to full cold (9 o'clock) prior to removing the four screws securing the lever to the valve. Carefully remove the temperature lever to reveal the red temperature preset override ring and the white temperature preset location ring. Neither of these parts need to be removed for installation. However if they are removed please take a note of their orientation on the valve prior to removal (as illustrated).



**5** Carefully remove the shroud from the valve assembly.



**6** Fit the elbows to the valve body hand tight, ensuring that the rubber washers are correctly engaged (these are supplied in the screw pack).

**7** If the valve is being installed for use with a gas fired instantaneous (multipoint) water heater or a combination boiler, the cold water flow regulator must be fitted at this stage by insertion into the cold water port as shown, ensuring the O' ring faces the incoming flow (the flow regulator is supplied in its own pack).



**8** The Colt valve is supplied with an outlet cap on the bottom of the valve allowing for a top outlet connection. The bottom outlet can be used by simply removing the cap and repositioning it on the top outlet. If the cap is removed please ensure that when replaced the membrane in the cap is in place and that the cap is done up tight.

**9** Fit the outlet connector ensuring the rubber washer is correctly engaged (supplied in the screwpack), on the required outlet ensuring a tight fit. Offer the valve up to the required fixing position to check the four fixing points are correct and there is adequate space available around both the inlet elbows and outlet connector. Prepare the wall fixings as required.

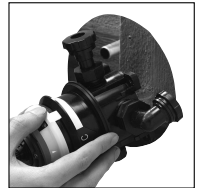

**10** Using a silicone based lubricant, lubricate the supply pipe ends and whilst supporting the elbows, push home the supply pipes ensuring the correct orientation for the inlet pipes (HOT LEFT AND COLD RIGHT AS SHOWN ON THE VALVE BODY). Push the valve fully home until a definite stop is reached (tube insertion depth is 25mm). Secure the valve assembly to the fixing surface using the screws provided.



**11** Construct a suitable 15mm outlet supply. The Aqualisa adjustable height head will need a 15mm outlet supply to a suitable point for the wall outlet.

**!** For the ceiling mount head, run a 15mm outlet pipe from the valve to the preferred position for the fixed head, terminating in a suitable 22mm compression fitting.

**12** Using a suitable tool, tighten both the elbow nuts and outlet connector nut until water tight.

**13** The installation may now be checked for leaks. Push the on/off knob onto the front of the valve fully home and turn the knob fully clockwise to ensure the valve is fully turned off.



**14** Turn on the supplies and check for any leaks upstream of the valve. Slowly open the control and check for leaks downstream of the valve. If all is sound, turn off the on/off knob fully, turn off the supplies and remove the on/off knob.

**15** Place the mortar guard around the valve and fill in the chase. Once the in-filling material has set, carefully remove the polystyrene to expose the valve body.

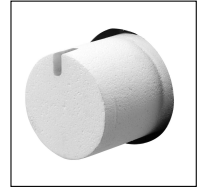

**!** **THE MORTAR GUARD MUST BE USED**

**16** Refit the red temperature preset override ring and the white temperature preset location ring if removed prior to installation, taking care to fit the override ring in the correct orientation as outlined in step 4. Before replacing the shroud, ensure the shroud seal is in position as indicated.



**17** Replace the shroud ensuring that it is fully fitted against the shroud support ring as shown.



**18** Using a silicone based lubricant or liquid soap, lubricate the wall plate seal. Apply a thin bead of silicone mastic into the groove on the rear of the wall plate and carefully push the wall plate into position flush with the wall ensuring correct orientation of the temperature markings.



**19** Depress the maximum temperature stop button and replace the temperature lever onto the valve in the full cold (9 o'clock) position. Replace the four screws to secure the lever to the valve hand tight only.



**20** Push the on/off knob onto the valve fully home. The two finger scallops should be uppermost when the valve is fully off. Locate the on/off knob face plate into position and secure using the small screw provided.



**21** After checking that the badge recess in the on/off knob is clean, dry and free of dust, remove the paper backing from the badge and push firmly into position.



Please refer to page 16 to 19 for shower head installation instructions.

## Colt exposed valve installation

**!** In addition to the guide below it is essential that the written instructions overleaf are read and understood and that you have all the necessary components (shown on page 9) before commencing installation. Failure to install the product in accordance with these instructions may adversely affect the warranty terms and conditions. Do not undertake any part of this installation unless you are competent to do so. Prior to starting ensure that you are familiar with the necessary plumbing regulations required to install the product correctly and safely.

Colt exposed is supplied with universal fixings.

**1** In most cases for hollow wall fixing it will be necessary to first install a suitable sound fixing surface within the cavity area before fixing the valve. Mark out the position of the pipe work entry points using the template provided. The 15mm supplies must emerge from the wall at right angles at 150mm pipe centres.

The template may also be temporarily secured to the wall to ensure correct orientation of the pipe work during making good if required.



**2** After making good, using the template, mark and prepare the four fixing points as outlined above.

**IT IS ESSENTIAL THAT THE WALL SURFACE IS FLAT AND EVEN TO AVOID DISTORTION OF THE SHOWER BACK PLATE.**

- 3** Remove the fixing screw from the centre of the valve fascia and carefully lift the upper shroud assembly clear from the back plate.



- 4** Remove the two fixing screws to release the lower shroud assembly from the back plate. Carefully remove and set aside.

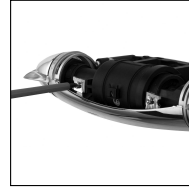

- 5** Remove the gripper ring assembly from the rear of the back plate and ensuring correct alignment of the gripper rings, slide over the projecting pipes flush to the wall face. Cut the supply pipes to their finished length (18mm – 21mm) using a rotary type cutter.



- 6** Briefly run the hot and cold supplies to flush out any debris that may be present in the system.

- 7** If the valve is being installed for use with a gas fired instantaneous (multipoint) water heater or a combination boiler, the cold water flow regulator must be fitted at this stage by insertion into the cold water port.

(The flow regulator is supplied in its own pack).

Remove the four cartridge fixing screws and carefully detach the cartridge assembly from the back plate. Fit the flow regulator into the cold port fully home, with the central O'ring facing the incoming flow. A small length of 15mm pipe may used to facilitate the installation of this regulator. Refit the cartridge to the back plate using the four fixing screws ensuring the hot and cold markings on the cartridge are uppermost.



- 8** Run a thin bead of silicone sealant in the mastic groove of the back plate. Using a silicone based lubricant, lubricate the projecting pipe ends before carefully pushing the shower valve into position fully home. Secure using the screws provided.

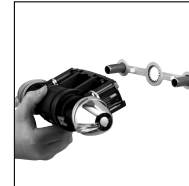

**9**

Refit the lower shroud by locating the lugs into the back plate and move the shroud into position. Align the fixing screws with the screw holes, and fix into place ensuring not to overtighten the fixing screws.

**10**

The installation may now be checked for leaks. Turn the on/off knob (left hand knob) fully forwards to ensure the valve is fully turned off. Attach the shower hose to the "!" BSP outlet on the underside of the valve to allow the water to discharge safely to waste.

**11**

Turn on the supplies and check for any leaks upstream of the valve. Slowly open the on/off control and check for leaks downstream of the valve. If all is sound, turn off the on/off knob fully and turn off the supplies.

**12**

Refit the upper shroud assembly by locating the lugs into the back plate and moving the shroud down into position. Fix using the centrally located locking screw taking care not to overtighten.

**13**

Remove the paper backing from the badge and push firmly into position in the recess in the shroud assembly.



Please refer to page 16 to 17 for shower head installation instructions.

## Adjustable height head installation

**!** In addition to the guide below it is essential that the written instructions overleaf are read and understood and that you have all the necessary components (shown on page 9) before commencing installation. Failure to install the product in accordance with these instructions may adversely affect the warranty terms and conditions. Do not undertake any part of this installation unless you are competent to do so. Prior to starting ensure that you are familiar with the necessary plumbing regulations required to install the product correctly and safely.

Adjustable height heads are supplied with universal fixings.

The adjustable height heads are suitable to be fitted with either concealed or exposed shower valves. A wall outlet assembly is supplied for installation with a concealed valve. If fitting with an exposed valve please proceed to instruction 7.

- 1 Prepare pipe work from the shower valve to the required position for the hose outlet using a  $\varnothing 15\text{mm}$  copper pipe. Slide the 15mm gripper ring down the projecting pipe up to the wall face.

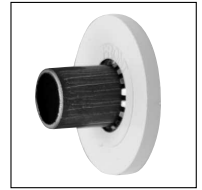

- 2 Trim the projecting pipe to a length of 15-22mm using a rotary type cutter. If a hacksaw is used, the pipe end must be carefully de-burred and chamfered.

- 3 Clean and lubricate the pipe using a suitable (silicone based) lubricant.

- 4 Remove the wall outlet cover plate and carefully slide the wall outlet onto the projecting pipe. Turn to the required position and mark the screw holes on the wall face.

- 5 Remove the wall outlet and drill and prepare suitable wall fixings. Ensure the projecting pipe is clean and lubricate again if necessary. Refit the wall outlet and secure it to the wall using the screws provided.



- 6 Refit the wall outlet coverplate.





- 7** Drill and plug two holes 642mm-655mm vertically apart using a spirit level to facilitate if necessary. Fit the rail end clip into position and loosely fit the lower bracket into position.

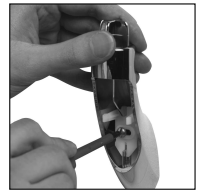

- 8** Pass the rail through the handset holder whilst keeping the slider levers depressed with the handset holder pointing in a downward direction.



- 9** If the soapdish is required slide onto the rail under the handset holder.

- 10** Current water supply regulations state the handset should not be allowed to pass a point 25mm above the spill over level of the bath or shower tray. If this cannot be achieved, the hose restraint must be fitted. This is fitted to the rail under the soapdish.

- 11** Fit the rail into the rail end bodies taking care to engage the location slot onto the lugs.

- 12** Fit the rail end clip fitting into position into the top rail end body and secure the rail assembly to wall using the screws provided ensuring the rail and rail end bodies remain firmly engaged.



- 13** Place the rail end covers into position and push firmly into place.



- 14** If required, pass the hose through the hose restraint. Ensuring the hose washers are in the correct position, depress the anti-swivel locking button on the handset and secure the handset to the hose. Connect the hose to the outlet connection and place the handset into the handset holder.

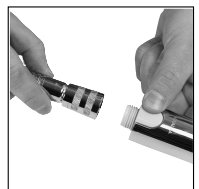

## Ceiling mounted fixed head installation

**!** In addition to the guide below it is essential that the written instructions overleaf are read and understood and that you have all the necessary components (shown on page 9) before commencing installation. Failure to install the product in accordance with these instructions may adversely affect the warranty terms and conditions. Do not undertake any part of this installation unless you are competent to do so. Prior to starting ensure that you are familiar with the necessary plumbing regulations required to install the product correctly and safely.

The ceiling mounted fixed head is supplied with screws for fixing the product to a noggin.

### A NOGGIN MUST BE USED AS PART OF THIS INSTALLATION

**1** Run a 15mm outlet pipe from the valve to the preferred position for the fixed head, terminating in a suitable 22mm compression fitting.

**2** Locate the position for the fixed head in the bathroom and firstly drill a pilot hole to mark the position before checking that there is suitable space behind the ceiling for the fixing assembly.

**!** The minimum height required behind the ceiling is 50mm and the space must allow for an 80mm wide, 50mm deep noggin to be used to support the assembly.



**3** Drill a hole (minimum  $\varnothing 28\text{mm}$ , maximum  $\varnothing 40\text{mm}$ ) through the ceiling and the noggin.

**4** Remove the fixing bracket carefully from the fixed head arm.

**5** Set the fixing bracket into position and mark the fixing points. Remove the bracket and drill and prepare suitable fixings. Refit the fixing bracket and secure it through the ceiling and into the noggin using the screws provided if suitable.



**6** Feed the arm through the fixing bracket to the correct depth. Tighten the nut using a 32mm spanner if necessary to facilitate.



**7** Cut off the excess pipe allowing for a suitable working length to allow for the required 22mm connection. If a push fit connector is to be used then the pipe must be abraded to remove all chrome plating.

**8** Connect the pipe work from the valve to the end of the fixed head pipe using a suitable coupling.

**!** Run the shower for a few seconds to clear any debris and to check for any leaks.

**9** Lubricate the O'ring if necessary and carefully slide the cover plate back over the fixed head arm and into position against the ceiling.



**10** Secure the cover plate to the arm using the grub screw and 2.5mm hexagonal key provided.



**11** Ensuring the flat washer is in place, carefully screw the shower head to the formed arm taking care not to damage the plated surface. Carefully tighten the shower head with a suitable tool taking care not to overtighten.



## User guide – Colt concealed

### Shower operation

1. Turn the on/off knob FULLY anti-clockwise into the open position to turn the shower on.  
**NB. The on/off knob MUST NOT be used as a method of flow control.**
2. Rotate the temperature control lever, depressing the red temperature limit button if required, to select a comfortable showering temperature using the temperature markings as a guide.
3. Turn the on/off knob fully clockwise into the closed position after use.



### Shower operation

1. Turn the on/off knob fully into the open position to turn the shower on.  
**N.B. The on/off MUST NOT be used as a method of flow control.**
2. Rotate the temperature control lever to select a comfortable showering temperature using the temperature markings as a guide.
3. Turn the on/off knob fully into the closed position after use.



## User guide - Harmony adjustable height shower head

1. Rotate the sprayplate lever clockwise or anti-clockwise to select the desired spray pattern.  
**N.B. When the lever is in the 3 o'clock position when viewed from below, the water saving mode is selected. This provides the same spray pattern as position 3 but, depending on the water system the product is fitted to offers up to 25% water saving.**
2. To select the preferred height for the shower head, depress the handset holders fully to enable the slider to be moved up or down the rail.
3. Angular adjustment is made by carefully but firmly pulling forwards or pushing back the shower head against the knuckle ratchet in the holder.

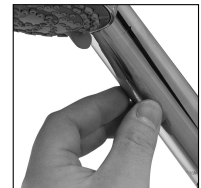

## User guide - Fixed shower head

1. The shower head is mounted on a multi-directional ball joint to allow angular adjustment in any direction by carefully moving the head to the desired angle.

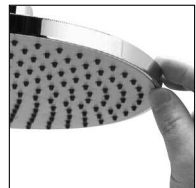

## Cleaning & maintenance

Once a week, with the shower valve fully open we recommend turning the temperature control lever from full cold through to full hot several times to activate the internal valve anti scale mechanism.

Your Colt shower system should be cleaned using only a soft cloth and washing up liquid.

### **! DO NOT USE ABRASIVE CLEANERS.**

To reduce the need for chemical descaling in hard water areas, your shower head incorporates a 'clear flow' system, whereby any scale build up can be broken down by gently rubbing the flexible tips of the jets during use. This procedure should be completed regularly, as often as once a week in some hard water areas, as scale build up can affect the spray pattern and cause the shower to perform poorly. Failure to descale the shower head can affect the internal seals and may affect the warranty.

Should chemical descaling of the head become necessary, remove the shower head fully and immerse in a mild proprietary descalent.

**IT IS IMPERATIVE THAT DESCALING IS CARRIED OUT STRICTLY IN ACCORDANCE WITH THE MANUFACTURERS INSTRUCTIONS. SUBSTANCES THAT ARE NOT SUITABLE FOR PLASTICS AND ELECTROPLATED SURFACES MUST NOT BE USED.**

## Commissioning – Colt concealed

The Colt concealed valve is pre-set to a safe maximum shower temperature. During use, the action of the stop button may be overridden by depressing it as the temperature control is rotated. Should it be necessary to reset the maximum temperature position please observe the following procedures.

1. Ensure that the hot water system is at normal maximum temperature.
2. Turn the temperature control lever to the full cold position (9 o'clock).
3. Carefully remove the on/off knob.
4. Remove the temperature control lever screws and pull the lever clear.
5. Carefully remove the red pre-set override ring and re-set in the appropriate direction to increase (clockwise) or decrease (anti-clockwise) the temperature where the override button needs to be pressed.
6. Depress the stop button and replace the temperature lever in the full cold position. Push the on/off knob into position fully home, but do not secure with the small screw at this stage.
7. Test the shower by turning it on and slowly increasing the temperature, at the selected point, the button should pop up and prevent further movement.
8. Repeat the above process if the maximum temperature stop button needs further adjustment.
9. Follow steps 19 to 21 on page 13 to re-fit the temperature lever and on/off knob.

**Should the on/off knob need to be removed at any time, turn the knob fully clockwise to the off position. Carefully depress the left hand side of the badge using a suitable tool taking care not to damage the badge or the surrounding plated surfaces of the on off knob. The right hand side of the badge will lift clear of the recess enabling you to remove the badge, giving you access to the small screw fixing the knob in place. Remove the screw and pull the knob clear.**

**Should unacceptable damage to the badge occur when removing it from the recess, please contact Aqualisa customer services who will send a free of charge replacement.**

## Commissioning – Colt exposed

The Colt exposed valve is pre-set to a safe maximum shower temperature. During use, the action of the stop button may be overridden by depressing it as the temperature control is rotated. Should it be necessary to reset the maximum temperature position, please observe the following procedures.

1. Ensure that the hot water system is at normal maximum temperature.
2. Turn the temperature control lever to the full cold position (lever fully downwards).
3. Remove the temperature control fixing screw and pull the knob clear.
4. Remove the temperature control lever screws and pull the lever clear.
5. With the cam tooth engaged in the shaft sleeve keyway, turn the sleeve in the appropriate direction to increase or decrease the maximum temperature. (Each increment equates to approximately 1°C).
6. Relocate the cam into the cam locking ring and turn the shaft sleeve through 180° (one half turn) to lock the cam down.
7. Depress the red stop button and replace the temperature control knob in the full cold position and secure using the fixing screw.
8. Test the shower by turning it on and slowly increasing the temperature. At the selected point, the button should pop up and prevent further movement. Repeat the above process if the maximum temperature stop button needs further adjustment.
9. When the stop button is at the desired limit, refit the screw cover in the control knob.

**Should the shrouds need to be removed at any time, turn the knob fully clockwise to the off position. Carefully depress the left hand side of the badge in the middle of the front shroud fascia using a suitable tool taking care not to damage the badge or the surrounding plated surfaces. The right hand side of the badge will lift clear of the recess enabling you to remove the badge, giving you access to the small screw fixing the shroud in place. Remove the screw and lift the top shroud assembly clear. Remove the two fixing screws from the valve assembly and pull the bottom shroud clear.**

**Should the knobs need to be removed at any time, turn the knob fully downwards to the off position. Remove the screw covers from the middle of the control knobs with a suitable tool taking care not to damage the surrounding plated areas. Remove the fixing screws and pull the knob clear.**

**Should unacceptable damage to the badge occur when removing it from the recess, please contact Aqualisa customer services who will send a free of charge replacement.**

## Trouble shooting guide

Symptom	Possible cause	Action
Water output is either all hot or all cold, or cold only	Reversed inlet supplies	Check that the supplies correspond with the inlet markings
Water output is not hot enough	The temperature of the hot water cylinder is too low  Water flow through the hot water appliance is too fast	The cylinder temperature should be at least 15°C hotter than the blend  Check the flow rate recommendations with the heater manufacturer
Flow rate is poor and water temperature is low	Airlock in the hot water supply	Check that the pipe work is laid out in accordance with correct practices, paying particular attention to potential air-traps
Water temperature swings regularly between hot and cold	Cold water pressure is too high  The flow regulator has not been fitted (Combi boiler systems)	If the static water pressure exceeds 10 bar, install a pressure reducing valve (PRV) in accordance with the installation guide  Fit the flow regulator
Poor flow rate	Twisted hose Debris in shower head Debris in filters Debris in hot inlet flow regulator (combi boiler systems)	Check for debris and clear as necessary



# AQUALISA

Aqualisa Products Limited  
The Flyer's Way  
Westerham Kent TN16 1DE

Customer helpline: 01959 560010  
Brochure Hotline: 0800 652 3669  
Website: [www.aqualisa.co.uk](http://www.aqualisa.co.uk)  
Email: [enquiries@aqualisa.co.uk](mailto:enquiries@aqualisa.co.uk)

Republic of Ireland  
Sales enquiries: 01-864-3363  
Service enquiries: 01-844-3212



Part No:659301 Issue 02 May 13

Please note that calls may be recorded for training and quality purposes

The company reserves the right to alter, change or modify the product specifications without prior warning

© Registered Trademark Aqualisa Products Limited