

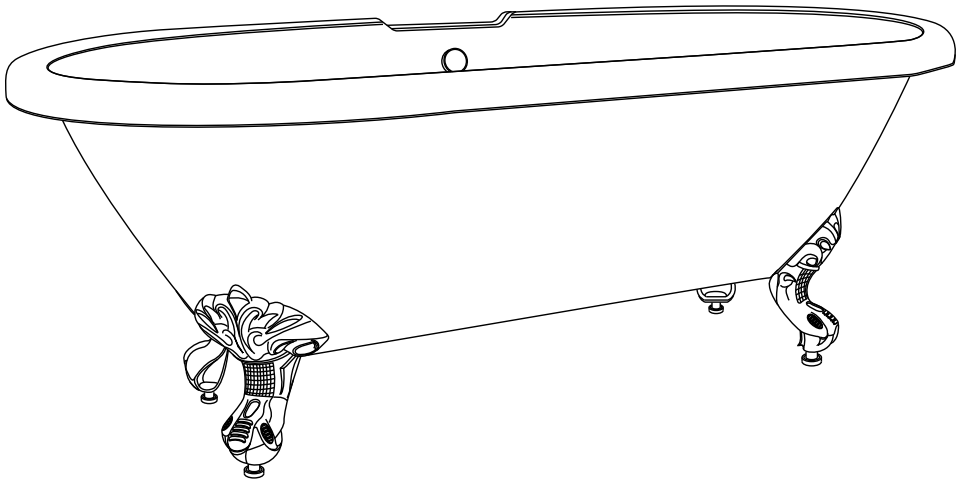

**victorian
plumbing.co.uk**

Traditional Freestanding Bath



Fitting Instructions







Please follow them carefully and
leave this manual with end user

Installation Guide

Before installation, please read this guide carefully.

1. **We recommend that this product is installed by a qualified tradesperson**, Victorian Plumbing Ltd. accept no liability for products incorrectly installed, or where the correct testing procedures have not been adhered to, thus resulting in the escape of water and consequential damage.
2. This product may require two people to carry out this installation.
3. Observe all local plumbing and building codes & regulations.
4. The freestanding bath is not designed to take weight on the rim. Do not sit or stand on the bath rim.
5. Ensure the incoming mains water supply is switched off prior to commencing the installation.
6. Carefully inspect the product for damage. If any damage is found, immediately contact our Customer Relations Team.
7. Ensure the bath is completely protected, leave the covering in place until the bathroom is complete. Scratches and cracks incurred during installation are not covered by the warranty.

Fitting List:

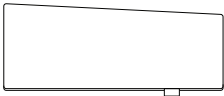
No.	Description	Picture	Qty
A	Bars		4
B	Hex Bolt		4
C	Hex Nuts		12
D	Washers		12
E	Fastener Washer		4
F	Adjustable Feet	 <p style="text-align: center;">OR</p> 	4

Tools Required (Not Included):

Ensure the appropriate PPE is used during installation



Pencil

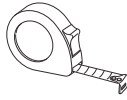

Tape Measure



Spirit Level



Adjustable Wrench



Adhesive Sealant

Step 1:

- Place the bath face down on the floor (ensure that the bath is protected from scratches), unscrew the Nuts (C) and Washers (D) that are pre-assembled on the bath.
- Place the bars on the bath (as shown in the image below), position the washers and screws, then partially fasten the screws to allow for adjustment before final fitting.

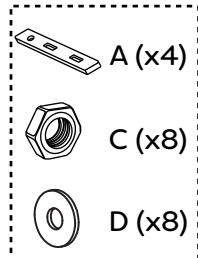
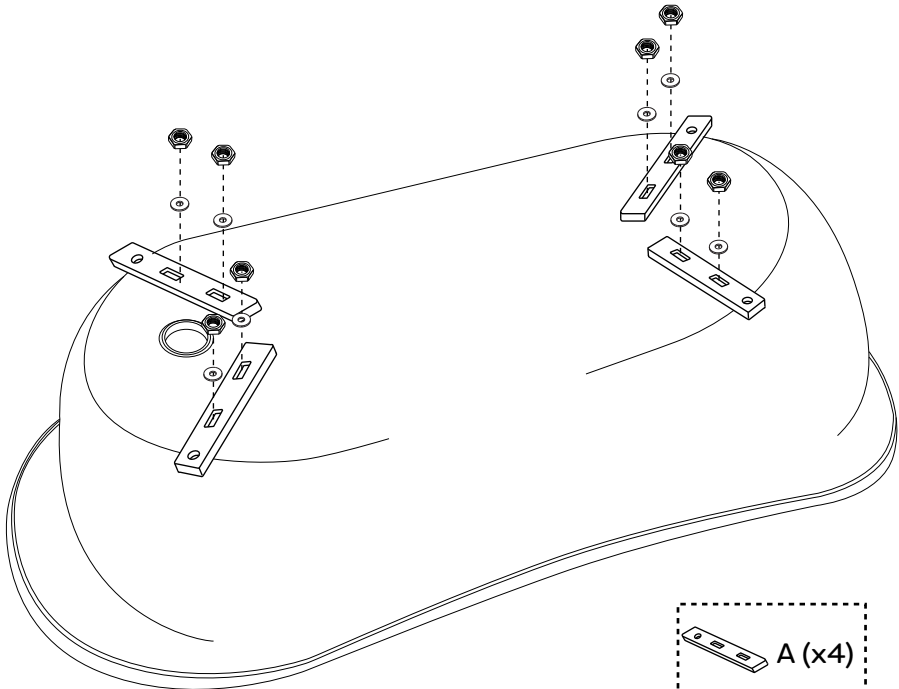

Step 2:

- Position the Adjustable Feet (F) to the corners of the bath. Ensure that feet correctly fit the bath (that there is no large gap between the bath and feet), adjust the Bars (A) as necessary.
- Once the feet has been adjusted into the desired position, tighten the bolts on the bar to fix the bar to the bath. Then use the Hex Bolts (B), Washers (D) and Fastener Washer (E) to fit the bath feet to the bar, tighten to secure into place (ensure the bath feet are firmly fixed to the bath to prevent any movement).

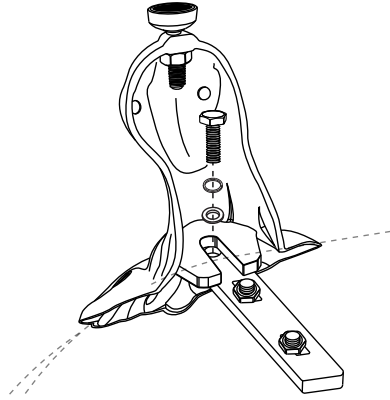
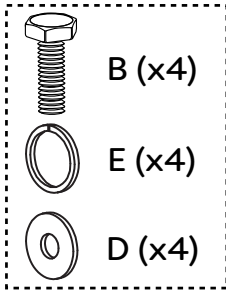

Step 3:

- Carefully turn the bath upright so that the bath is resting on the feet (check that the bath is stable). Position the bath into your desired position on the floor and using a spirit level, ensure the bath is level. Adjust the bath feet as necessary to achieve the desired level.

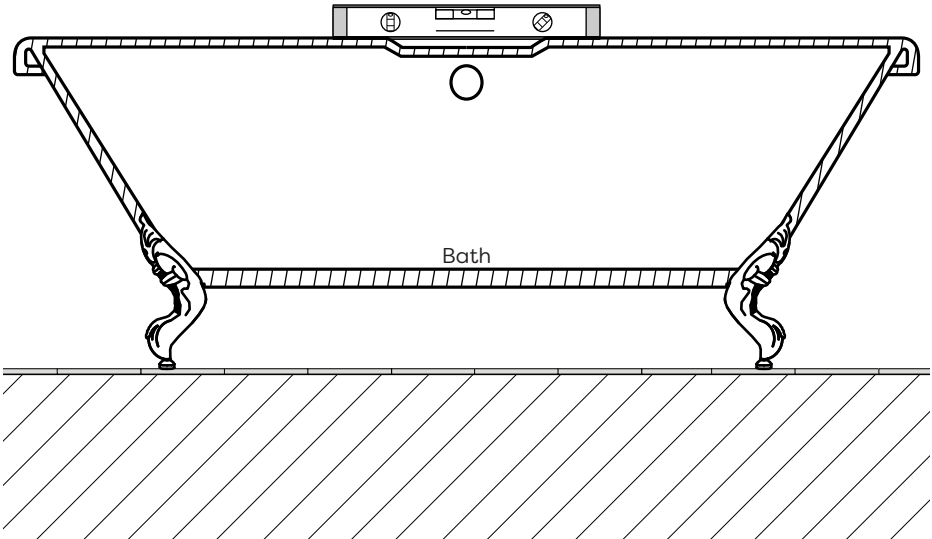

Step 4:

- Using a pencil or any marker, mark the floor with the outline of the bath feet in the desired location.

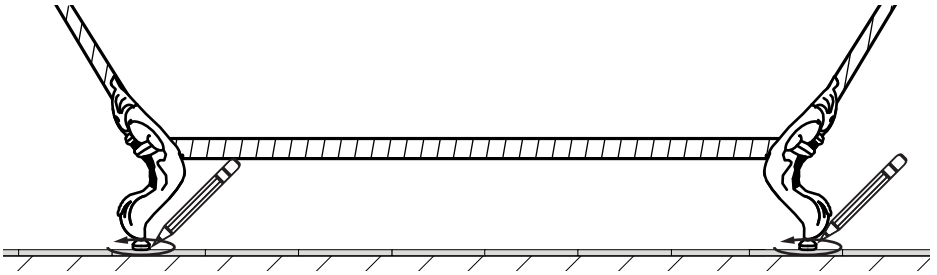

Step 5:

- Carefully tilt the bath on its side. Attach your chosen bath waste and overflow (not included) to the bath. Refer to the instructions of your bath waste and overflow for guidance if needed.

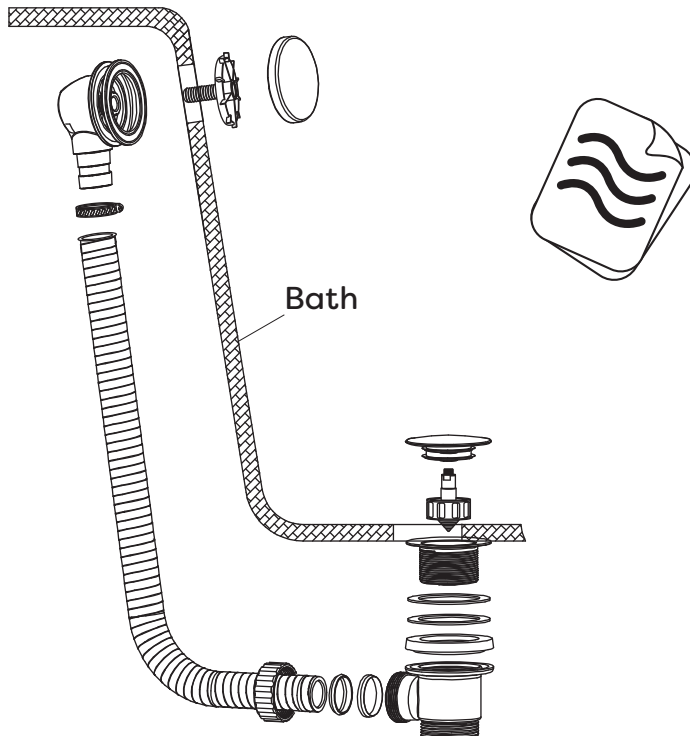

Flexible connector and waste trap are not supplied

Step 6:

- Attach your chosen waste trap to the bath waste then use a drain pipe or flexible connector to connect the trap to the waste outlet.

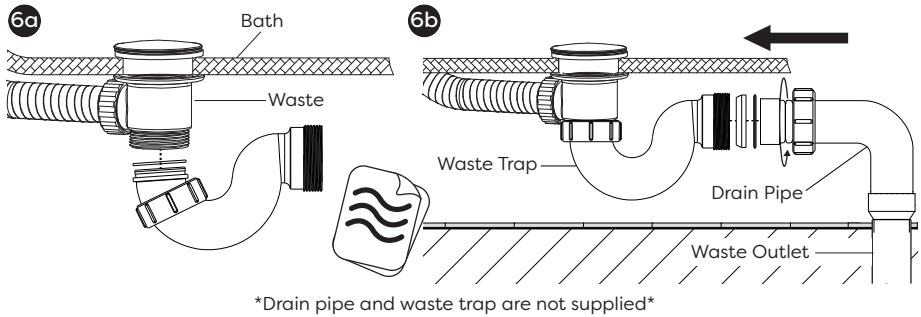

Step 7:

- Pipe a fine bead of good quality adhesive sealant on bottom of the bath feet.
- Position the bath on the floor marking (as marked on step 4), make sure that the drain pipe is not kinked upward on installation as this will result in a drainage issue.
- Remove any excess adhesive with a damp cloth and allow 48 hours for the adhesive to fully cure.

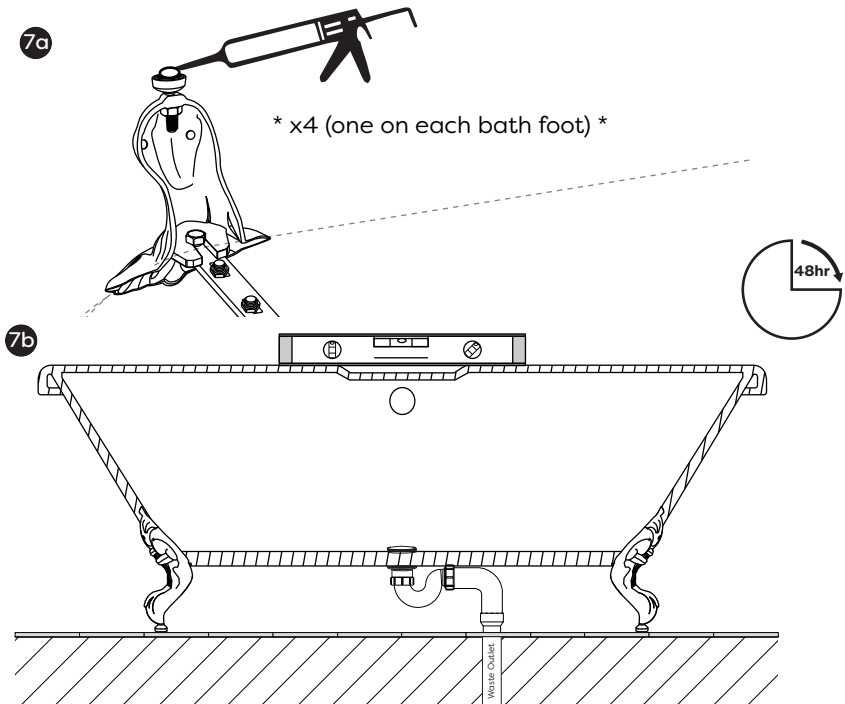

Water testing:

- Water test your bath prior to enclosing to ensure that it drains correctly, as claims for non draining baths will be invalid after final enclosure or tiling has been done.
- Test the overflow pipe and waste, check for any leaks.

Aftercare:

- To preserve the polished surface, after using your bath, clean with a soft cloth and warm soapy water.
- Do not use powders, pastes, crème cleaners, thinners, window cleaning sprays, dry cleaning liquid, etc.
- When coloured essential oils are used, first test that the colour won't stain your bath. Always add oils to a bath full of water. Never pour them into an empty bath.



Notice (Tap holes drilling if applicable)

- Pay attention to the below points if the bath is designed with the tap deck.
- The tap holes are not pre-drilled on the deck, you will need to drill the holes according to your needs.
- Check and silicone the tap holes to make sure they are solid after drilling.
- Check and make sure that there is no water leakage at the faucet.

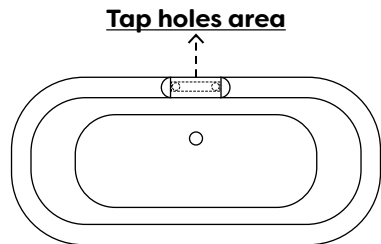
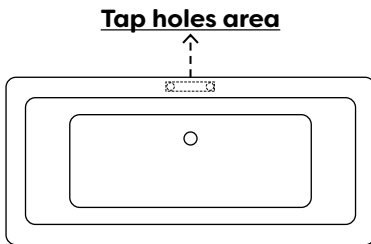
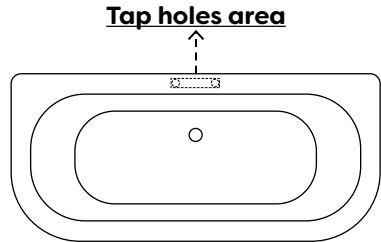
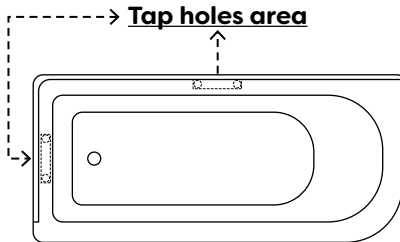

** Illustrations are for reference only **



Make sure the reinforcement in the tap holes are solid before installing the faucet



www.victorianplumbing.co.uk