



5 Year Warranty - Terms and Conditions:

In the unlikely event that you should experience any defect in the materials or workmanship of your new Abode mixer within 5 years of purchase, the purchaser's sole remedy shall be the replacement (at the manufacturer's discretion) of all or any part of the product that is defective. All working parts and valves are guaranteed for a period of 5 years from purchase. Decorative surface finishes and O-rings are guaranteed for 1 year from the date of purchase provided that our advice concerning care has been observed and no scouring agents have been used. This is provided that the mixer or tap has been used for normal domestic purposes and that the care, installation and maintenance instructions have been observed. The warranty extends to the original purchaser only.

Marks, scuffs and scratches caused by improper installation or accidental damage are not covered by this guarantee. Neither are shade variations, or any damage or defect caused by incorrect installation or abuse of the fitting.

As we are continuously improving and developing our range of products, finishes & colours, in the event of a valid claim, we may not be able to provide an identical replacement for the defective product throughout the guarantee period. Where an identical product is no longer available, we will supply the nearest equivalent from our then current product range. In assessing your claim, we must be given the opportunity to inspect the product as installed prior to removal. Any product returns must be packaged securely as received and complete.

No other warranties, express or implied, are made, including merchantability or fitness for a particular purpose. Under no circumstances shall the manufacturer be liable for any loss or damage arising from the purchase, use or inability to use this product, or for any special, indirect, incidental or consequential damages. No liability is accepted for consequential damage to other household fixtures, fittings or furnishings arising from this claim, even if attached to the product. No installer, dealer, agent or employee of Abode has the authority to modify the obligations or limitations of this warranty.

You should read these instructions throughout carefully before commencing installation, especially if you have not installed this product previously. If you have any doubts or questions, then you should contact a qualified professional to install this product.

Before You Begin:

- Remove the Swich and filter from its packaging, check for any transport damage and that all parts are present.
- Isolate the cold-water supply to the area around the tap as required, this can be checked by turning on the cold water tap. Drain as much water as possible from the nearby system.

Stage 1 - Preparation:

- 1) Where to locate the Swich? The Swich can be placed in several places...
 - I. Through an existing taphole in your sink that may be covered with a blanking plug that can be removed.
 - II. Creating a new taphole through your sink. If the sink has a large tap deck or if the sink design is reversible, and there is provision for a 2nd taphole, you may cut through at the point indicated by the manufacturer.
 - III. Through the worktop around the sink area. Please note the maximum permissible worktop thickness is 55mm.
Remember...
 - Any new taphole created for Swich should be 35mm diameter (+3 / -1mm).
 - A minimum radius of 33mm (from the taphole centre) must be around the Swich so the handle may turn freely.
 - Sufficient space under the Swich must be present to allow for plumbing connections and access to install the product.
 - **Always roughly assemble the product and plan the best position for Swich and subsequent plumbing, before making an additional taphole in your kitchen.**
- 2) Determine the type of tap to be used in conjunction with the tap. This can be one of two types...
 - I. A 'single flow' tap, this is most common where the tap has only one operating handle and has only one path through the spout for both hot and cold water to pass through.
 - II. A 'dual flow' tap, this is most common where the tap has 2 handles to operate hot and cold water independently, the tap spout will have 2 separate pipes or channels for the hot and cold water passing through the spout. This can be seen by unscrewing the end of the spout and looking inside the spout.
 - a) If your tap is 'dual flow' the non-return valve section (X6) of the Swich will not require installation.
 - b) If your tap is 'single flow' the non-return valve section (X6) must be installed on the cold-water feed to the tap to prevent backflow. Note the non-return valve section (X6) should already have been installed at the same time as your tap to prevent backflow and should be reused where indicated.
 - c) If you are unsure about the type of tap installed, then ensure the non-return valve section (X6) is installed regardless.

Stage 2 - Install Switch:

1) Decide on the location of the product (**A1**) and prepare the taphole.

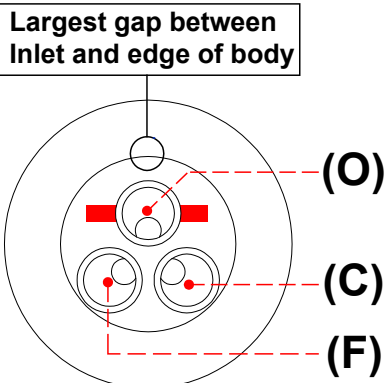
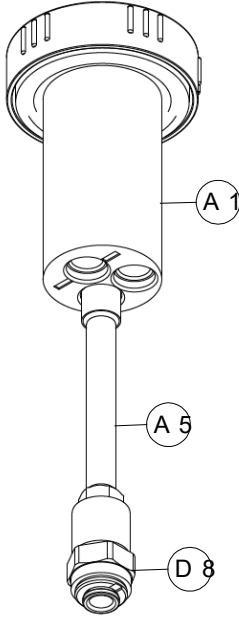
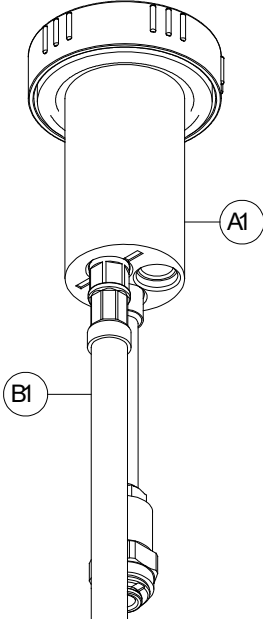
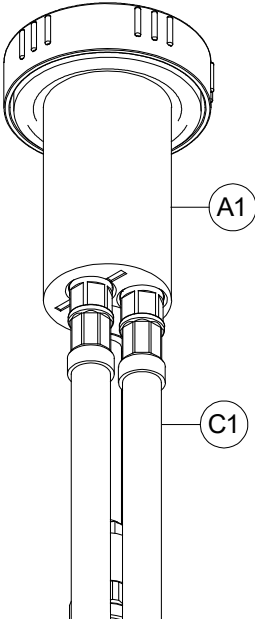
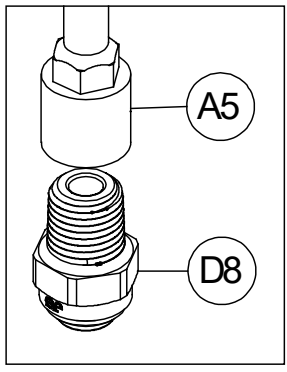
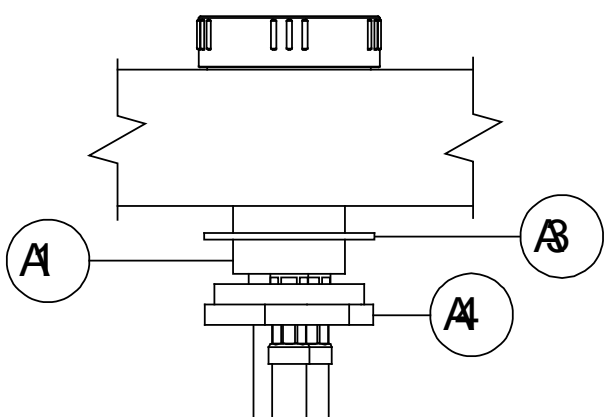
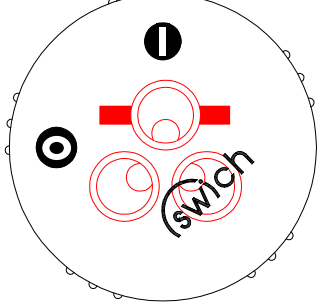
| | | | |
|---|---|---|---|
| <p>Fig 1. Switch inlets, viewed from underside:</p> <p>(O) = Output (B1) (C) = Cold in (C1) (F) = Filter in (A5)</p> <p>Largest gap between Inlet and edge of body</p>  |  |  |  |
| <p>Fig 2.</p>  | <p>2) Screw the small pushfit adaptor (D8) into extension leg (A5) using PTFE tape on the thread (see Fig 2.), do not overtighten the plastic pushfit adaptor.</p> <p>3) Screw the extension leg (A5) into the base of the product, listed (F) on the diagram (Fig 1.) for base inlets.</p> | <p>4) Screw the flexi tail (B1) into the base of the product, (O) on the diagram (Fig 1.) for base inlets.</p> <p>NOTE: (O) is the inlet with the largest gap to edge, also physically marked with a red line.</p> | <p>5) Screw the flexi tail (C1) into the base of the product, (C) on the diagram (Fig 1.) for base inlets.</p> <p>Note: If these steps are not followed correctly, then you will experience no water flow when the handle is turned left or right.</p> |
|  | <p>6) Pass the product (A1), extension leg (A5), flexi tail (C1) and flexi tail (B1) through the taphole from above the sink or worktop.</p> <p>7) Pass the lower gasket (A3) then fixing nut (A4) over the threaded section of the product (A1).</p> | | |
|  | <p>8) With Switch (A1) central to the taphole, hold the underside body and fully turn product handle (A1) fully clockwise.</p> <p>With the flexi tail (B1) located nearest to the front and the I symbol furthest away, tighten the fixing nut (A4) fully.</p> | | |

Stage 3 - Mount The Filter Cartridge:

1. Locate a convenient position to install the filter (**D4**), remembering that it must be easily accessible when it is changed, remove any dust caps from both ends of the filter.
2. Screw the filter bracket (**D6**) to the sink cupboard wall using screw (**D7**), if attaching the bracket to a wall use a rawl plug.
3. Write the installation date onto the filter (**D4**) label in permanent pen.
4. Clip the filter (**D4**) into its bracket (**D6**) respecting the flow direction, the flow direction is marked on the filter body (**D4**) with an arrow.

Important...

- The filter cartridge (**D4**) performs best when mounted vertically and when the blue pipes (**D3, D5**) are as short as practical.
- The filter cartridge (**D4**) will require a small amount of space around it to allow it to be replaced.
- Place the filter system and blue pipes (**D3, D5**) where they will not be accidentally damaged i.e. away from drawers & doors.
- Locate the filter cartridge (**D4**) where it is easily accessible to the owner for replacement.

Stage 4 - Create The 'Break' In The Cold Water Supply To The Tap: (Retro Fitting To A Preinstalled Tap Only)

1. Decide on the most practical position for the 'break' in the cold water supply (see notes below).
2. Measure, then mark the required length of 15mm pipe to remove using a marker.
3. Cut both ends of the pipe using a pipe cutter. Ensure that both ends of the pipe are straight, burr free and cut squarely.
4. Remove the 'break' section of pipe.

Important...

- Locate the 'Break' as close as is practical to the tap.
- The 'Break' should be at least 30cm in length (if not requiring non-return valve section (**X6**) for single flow taps).
- The 'Break' should be at least 40cm in length (if requiring non-return valve section (**X6**) for dual flow taps).
- The connection size and type of the 'Break' will depend on your existing tap connections.
- The 'Break' will be replaced by the three-way tee (**D1**) this must be easily accessible to the user after installation as the lever must be operable when replacing the filter cartridge (**D4**).
- Any debris or swarf that may be in the feed pipes must be flushed away before reconnection to prevent damage to the Switch valve.

Example tap connections before the 'break' is created:

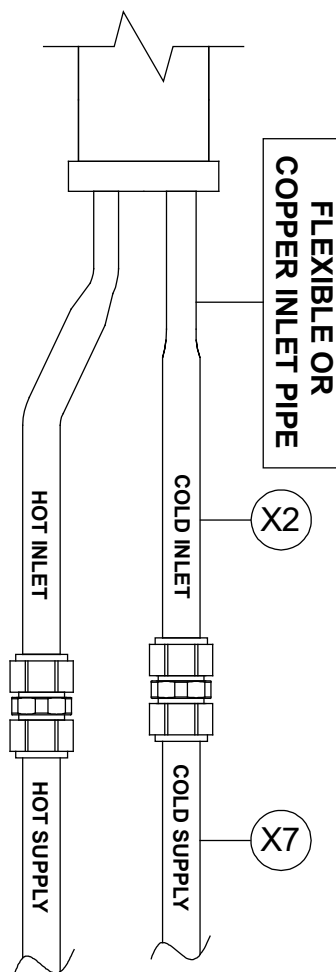

Example tap connections after the 'break' is created:

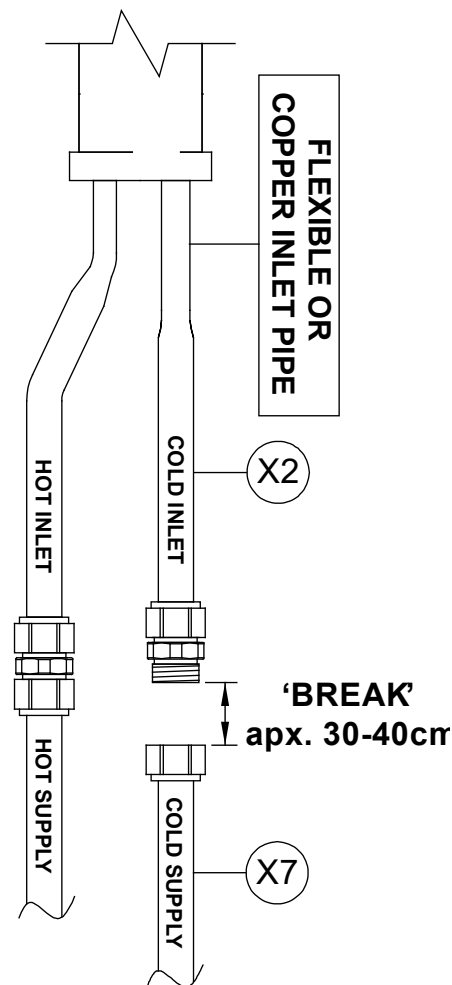

Stage 5 - Install The Non Return Valve Section (X6) (If Required, See Stage 1):

1. Pass compression nut (E2) then compression olive (E1) over the 15mm cold supply pipe (X7).
2. Push the non-return valve (E3) onto the 15mm cold supply pipe (X7), note the arrow on the non-return valve (E3) indicates the direction of flow, install the valve (E3) with the arrow facing away from the 15mm cold supply pipe (X7) and towards the tap.
3. Holding non-return valve (E3) tighten compression nut (E2) fixing non-return valve (E3) to the 15mm cold supply pipe (X7).
4. Cut a small stub section (approximately 50mm) of 15mm pipe (X8) using a pipe cutter, ensure that both ends of the pipe are straight, burr free and cut squarely.
5. Push the stub section of 15mm pipe (X8) into the non-return valve (E3), then pass compression olive (E1) then compression nut (E2) over the 15mm cold supply pipe (X8).
6. Whilst holding non-return valve (E3) tighten compression nut (E2) fixing non-return valve (E3) to the 15mm pipe section (X8).

Stage 6 - Install The Three Way Tee:

1. Connect flexi tail (C1) to the three-way valve (D1) ½" male output.
2. Screw the large pushfit adaptor (D2) onto the three-way valve (D1) ¾" male output.
3. Pass compression nut (E2) then compression olive (E1) over the 15mm cold supply pipe (X7 or X8) dependant on if the non-return is valve fitted.
4. Place the three-way tee (D1) onto 15mm cold supply pipe (X7 or X8) dependant on if the non-return valve is fitted. Note the blue lever valve on three-way tee (D1) should face forwards for easy access by the customer.
5. Whilst holding three-way tee (D1) tighten compression nut (E2) fixing the three-way tee (D1). To 15mm pipe (X8 or X7).

Stage 7 – Connecting The Blue Pipe & Flexi tails:

1. Cut a clean edge to the ¼" blue pipe (D5) then firmly push the thin ¼" blue pipe (D5) into the small pushfit adaptor (D8).
2. Roughly measure the ¼" blue pipe (D5) to the outlet pushfit in filter head (D4). Cleanly cut the ¼" blue pipe (D5) slightly longer than the length required and firmly push the ¼" blue pipe (D5) into the outlet pushfit in filter head (D4).
3. Firmly push the ¼" blue pipe (D3) into the large pushfit adaptor (D2).
4. Roughly measure the ¼" blue pipe (D3) to the inlet pushfit in filter (D4). Cleanly cut the ¼" blue pipe (D3) **slightly longer than the length required** and firmly push the ¼" blue pipe (D3) into the inlet pushfit in filter (D4).
5. Screw flexi tail (C1) onto the three-way tee (D1) ½" output.
6. Screw flexi tail (B1) onto cold inlet of the tap using union (X5) if required.

Correctly attaching Flexi hoses:

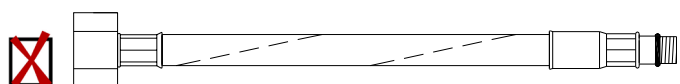

- The hose is twisted and stretched



- The hose is not twisted and slack is present

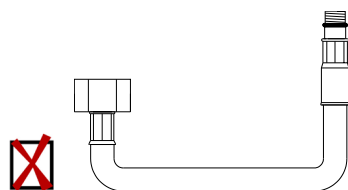

- The bends on the hose are too sharp and located too closely to either end of the hose

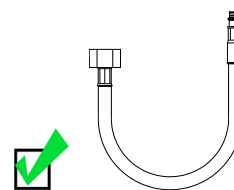

- The bend in the hose is a large smooth flowing radius; the bends are located away from the fitting ends.

Important...

- Self-adhesive cable ties and bases have been supplied to help temporarily keep the pipes tidy (i.e. on the underside of a sink or similar) during installation.
- Keep the pipes away from sources of heat, chemicals, sharp objects and items that are moved frequently and may dislodge connecting pipes such as unit doors and drawers.
- Never use blue ¼" pipe sections that are crushed, kinked or show signs of damage.
- When inserting a coloured pipe into a pushfit fitting, always ensure the pipe is parallel to the fitting and has sufficient spare length to ensure no tension is applied to the pushfit fitting.
- Never insert any object other than the blue ¼" pipes into the pushfit fittings.

Stage 8 - Setting Up The Filter:

Slowly turn the cold water supply back on; now carefully check the installed system at all joints for any leaks. If pressure testing equipment is available, check the installation to the maximum recommended pressure.

1. Turn the valve on the three-way tee (**D1**) to the open position.
2. Turn the Switch control handle to the **1** (filtered water on) position.
3. Turn the tap to the cold only position and onto full flow. Note any air in the system may take a moment to displace, then water will flow.
4. Adjust the three-way tee (**D1**) so the filtered water flows through the tap at approximately 2 litres a minute (this can be quickly double checked using a kitchen jug and watch).

Note for the GAC only filter: the slower the water passes through the filter system the better the filtered water will be.

Note for the GAC and resin filter: the slower the of water flow the more of the water is softened and the therefore the resin element of the filter will be exhausted more quickly.

5. Flush the filter system through for approximately 10-20 litres, you may notice some dark discoloration in the filtered water at this point, this is loose carbon from the filter its completely normal, harmless and will pass with flushing.
6. Turn the Switch control to the **0** (cold water) position, you should notice the flow of water increases over that of the filtered water **1** selection.

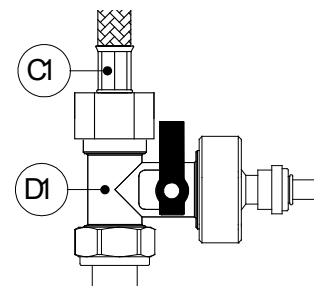

Three Way Valve (D1) open

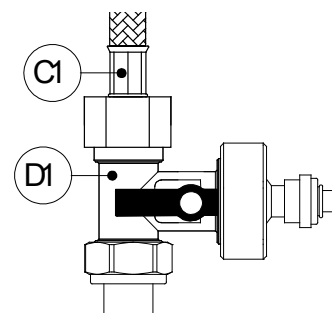

Three Way Valve (D1) closed

Using Switch:

Using Switch couldn't be easier, simply turn the Switch handle to select the type of water required, the 'click' will help to indicate when the handle is fully in the required position.

Position **0** (filter off) will select normal unfiltered cold water, position **1** (filter on) will select filtered cold water. Once Switch has selected the water type, turn on the kitchen tap on in the cold only water position.

When installed in the rotation described (with the output pipe (B1) nearest the front of the cupboard). The **0** or **1** uppermost on the control in the correct readable orientation is the water channel selected:

Some customers may find it more intuitive to turn the handle clockwise for filtered water and anticlockwise for cold water. In this instance the installer should swap over the inlet connections and associated pipes and fittings for (A5) and (C1):

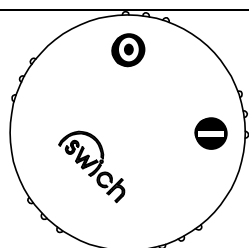

Cold water selected

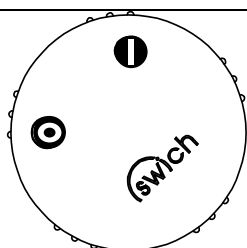

Filter water selected

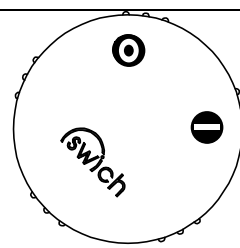

Filter water selected

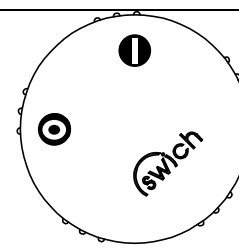

Cold water selected

- For best results when using the filtered water always run the tap for a few moments. Running the tap will help to flush the system through and will also make the water cooler for drinking. If the tap has not been used for some period, flush for longer.
- When comparing the taste of filtered and unfiltered water always taste the filtered water first, during the beginning of the filters operating life the taste of chlorine will be less distinct, and the water will be visually clearer.
- Each water filter is designed to improve the taste, clarity and odour of drinking water, the filter also reduces sediment, the level of some chemical impurities and scale build up on cookware (depending on your filter type).
- Each filter cartridge has a approximate six-month life depending upon your water quality, flow rate and usage. We recommend the cartridge is replaced periodically as indicated for reasons of hygiene.
- The Switch two filter types are fully interchangeable should you wish to swap the type from that already installed.

For replacement filters visit www.abode-shop.co.uk or call 01226 283434. Abode operate a free replacement filter reminder service, If you would like to take advantage of this service, please register online or call the number above.

| Key: | Description: | Qty |
|------|---|-----|
| A1 | Switch body | 1 |
| A2 | Upper seal | 1 |
| A3 | Lower gasket | 1 |
| A4 | Fixing nut | 1 |
| A5 | Extension leg | 1 |
| B1 | Flexi tail (Switch output feed to taps cold inlet) | 1 |
| C1 | Flexi tail (cold input to Switch from tee) | 1 |
| D1 | Three-way valve | 1 |
| D2 | Large pushfit adaptor | 1 |
| D3 | 1/4" blue pipe (Filter inlet) | 1 |
| D4 | Filter cartridge | 1 |
| D5 | 1/4" blue pipe (Filter outlet) | 1 |
| D6 | Fixing bracket | 1 |
| D7 | Fixing bracket screw | 1 |
| D8 | Small pushfit adaptor | 1 |
| E1 | 15mm compression olive | 2 |
| E2 | 15mm compression nut | 2 |
| E3 | Non-return valve | 0 |
| X1 | M12 x 1/2" M flexi tail (Cold water inlet) | 0 |
| X2 | 15mm tap inlet pipe (Cold water inlet) | 0 |
| X3 | M12 x 1/2" F flexi tail (Cold water inlet) | 0 |
| X4 | 15mm compression olive | 0 |
| X5 | 1/2" M x 1/2" M Adaptor or Union | 0 |
| X6 | Optional non-return valve section for single flow taps only (see stage 5) | 0 |
| X7 | 15mm cold water supply pipe | 0 |
| X8 | 15mm pipe stub section | 0 |
| n/a | Self adhesive cable tie bases | 2 |
| n/a | Cable ties | 2 |

Important Technical Data:

Switch can be used in conjunction with a water softening system and can substitute the requirement for a separate drinking water tap. In this instance three-way tee (D1) must cut into the unsoftened cold mains supply.

These installation instructions have been prepared for your guidance and you must exercise due care at all times. We do not accept responsibility for problems that may occur through improper installation, PTFE tape can be used to ensure watertight joints on threaded connections, do not over tighten connections or allow pipes to be twisted or folded.

We recommend fitting isolation valves before the Switch connections to ease any future maintenance.

Please ensure that your Switch is fitted in accordance with Local Water Byelaws.

Recommended Minimum Cold Water Pressure: 1.0 bar
Recommended Maximum Cold Water Pressure: 5.5 bar

Note: If these pressures are exceeded, even for short periods, damage can result.

The installation should be periodically checked for damage, if the property is left unattended for a prolonged period we recommend isolating water supplies.

Care Instructions for Switch:

To maintain the appearance of this product, ensure that it is regularly cleaned only using a clean, soft damp cloth. A solution of warm water and a mild liquid detergent may be used where necessary, and then the fitting rinsed thoroughly and wiped dry.

Abrasive cleaners, bleaches, scouring cleaners and acidic cleaners must not be used under any circumstances. Avoid contact with all solvents (including chlorinated solvents, ketones or acetones as these may result in surface deterioration or etching). Also avoid contact with any harsh household chemicals such as oven cleaners, drain cleaners, rust removers, paint strippers and toilet bowl cleaners.

Please leave all literature for your customer, for further information call 01226 283434 or visit www.abode.eu

Revision: 08/2021

