

## Important Technical Data

Whilst every effort has been made to make these instructions comprehensive they may not be exhaustive, we strongly recommend that this product is installed by a skilled professional. This will ensure the best possible finished installation.

This product is made from high quality fireclay for the greatest possible durability, after the end of the lifecycle of this product it should be disposed of responsibly. Please be aware that fireclay is a natural material therefore variations in size, flatness and finish should be expected

Earth bonding: under current IEE regulations there is no statutory requirement to earth bond sinks as most new wiring installations are protected with an RCD. If you are unsure if your wiring is protected by an RCD, contact a qualified electrician.

Maximum temperature +300°C\* Note: If this temperature is exceeded, even for short periods, damage to the finish can result.

Waste disposers should be mounted in such a way that the weight of the unit is supported by the kitchen cabinet carcass, not just the sink. Faulty or damaged waste disposal units can cause vibration – this will damage the sink and can loosen connecting pipework or fixings causing water leaks.

All Abode products are designed in accordance with recognised European or global standards. Please ensure that your Abode product is fitted in accordance with localised legislation.

The installation should be periodically checked for damage to water sealing parts as described in the instructions to avoid accidental water damage.

A full technical specification, Declaration of performance (DoP) and copies of these instructions are available for this product on our website. Please see [www.abodedesigns.co.uk](http://www.abodedesigns.co.uk) Abode is a registered trademark of Abode.



**CAUTION:** this product and its components can contain sharp edges, you must handle the product using suitable protective gloves during its installation, if cutting tap holes wear a suitable mask and eye protection.

## Manufacturers Product Reference



Norcros Group (Holdings) Ltd.  
T/A Abode  
Ladyfield House, SK9 1BU, UK

[www.abodedesigns.co.uk](http://www.abodedesigns.co.uk)

Production year: See product label

“Abode DoP”

Product code: See product label

Preparation of food, washing of dishes and discharge of domestic wastewater.

EN 13310

CA - DA

©Abode  
AX4002 v7 07/2021

# abode

Unit L, Zenith Park, Whaley Road, Barnsley, S75 1HT.  
Tel: 01226 283434 Fax: 01226 282434

[www.abodedesigns.co.uk](http://www.abodedesigns.co.uk)

All errors and omissions excepted.

**Please retain these instructions with the sink for future reference**

# Ceramic Inset Sink



## 10 Year Warranty Terms and Conditions

In the unlikely event that you should experience any defect in the materials or workmanship of your new Abode sink within 10 years of purchase, the manufacturer will repair or replace all or any part of the product that is defective, at their discretion. The manufacturer will not be responsible for any other consequential costs such as labour, removal or reinstallation of the sink or any other connected or related products.

This is provided that the product has been used for normal domestic purposes in the UK & Eire, and that the care, installation and maintenance instructions have been observed. The warranty extends to the original purchaser only. You should retain a copy of your dated invoice as proof of purchase to validate any claims under this guarantee.

Please note that this product is manufactured using natural materials so slight shade variations can occur. Marks, scuffs and scratches caused during installation or accidental damage are not covered by this guarantee.

## Care Instructions for your Kitchen Sink

**To maintain the appearance of this product, ensure that it is regularly cleaned using only a clean, soft damp cloth. A solution of warm water and a mild liquid non-antibacterial detergent may be used where necessary, and then the product rinsed thoroughly and wiped dry. Any other cleaning action will invalidate your warranty.**

No household or industrial chemicals should come into contact with this product to prevent damage. To prevent staining or discolouration of the product always rinse the sink with water after use, if you live in a hard water area we suggest you also wipe the sink dry.

Do not cut, slice or chop directly onto the sink you may mark the surface finish, avoid the use of plastic washing up bowls as engrained grit on the bowl underside may mark the surface finish. Avoid impacting the product with sharp or heavy objects, such as knives, pans or cooking pots and also avoid contact with abrasives. No hot objects should be placed directly onto the sink surface.

For further care and maintenance advice on removing stubborn marks and more examples of objects or actions likely to artificially shorten the life of this product, please visit our website.

**Please retain these instructions with the sink for future reference**

## Parts and Contents

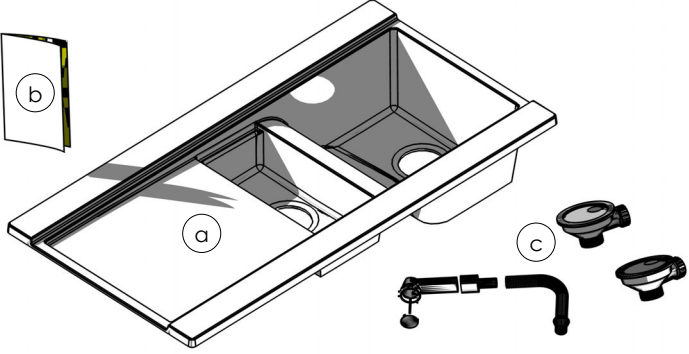
Key	Description	Qty	
A	Sink (may differ from model shown)	1	
B	Care instructions and cut out sizes	See included specification sheet	
C	Overflow, wastes and pipework	See included specification sheet	

## Installation Instructions

### Preparation

1. Take great care when handling this sink. Whilst every effort has been taken to remove sharp edges, the material by nature may be sharp and we recommend wearing gloves accordingly. Do not lift the product by the waste hole(s) or tap hole(s). Always use two people to handle this product.
2. Check the package for completeness and any transport damage before installation commences. Installed faulty product will not be honoured in the warranty.
3. Check that the supporting carcass and worktop is level left to right and front to back to ensure correct drainage of water.
4. Check that the surrounding furniture is the correct size and shape to accept this product and that no plumbing or wiring may foul the installation.
5. If replacing an existing sink, remove this product and clean the surrounding area, ensure the new sink will suit the existing cut out size and position.

### Installation

1. Before creating the cut out in the worktop, carefully plan the positioning of the sink. Ensure that the position of the bowl(s), tap and overflows will not interfere with surrounding units or appliances. To ensure perfect positioning of this product the cut out details are published on the included specification sheet and on [www.abode.eu](http://www.abode.eu).
2. **IMPORTANT:** Due to the larger dimensional tolerances on ceramic products we strongly recommend making the cut out in a scrap piece of material then checking it against the actual sink to be fitted. The cut out size should be adjusted to suit the sink tolerances and retested against the intended product before committing to cutting the final work surface.
3. Carefully mark out the cut out using the cut out drawing provided. Create the sink cut out in the worktop using a router or jigsaw following the manufacturer's instructions, taking care not to chip, crack or scratch the worktop. When preparing the cut out cover any open pipework to avoid any debris contaminating the water supply feeds.
4. Seal the cut edges of the worktop with a waterproof sealant to prevent any possible water damage to the worktop.
5. If the sink is a reversible design choose the orientation of the bowl(s) and drainer and follow steps 6-10. If the sink is handed skip to step 11.

- Choose the tap hole position(s) based on the bowl and drainer orientation. **Our recommendation (for reduced risk of accidental damage) is to use a 35mm diamond tipped hole saw to create the taphole, ensure to drill the product carefully, do not use 'hammer' setting on the drill.** Alternately carefully follow the knock out method as described below.

Fig 1.

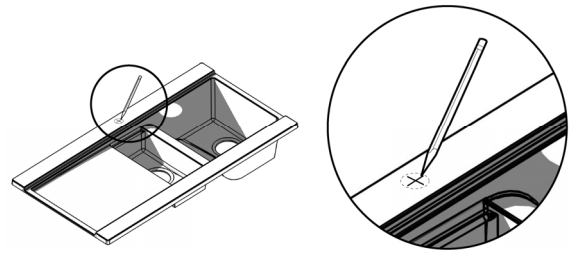

- You will require a centre punch and hammer to knock out the required 'part-depth' 35mm tap hole(s). **WARNING:** Always wear goggles and gloves when removing tap holes. With a pencil, mark the show face directly above the centre of the part-depth tap hole(s) (Fig1).

- Whilst supporting the tap deck, drive the centre punch through the centre of the part drilled tap hole with one sharp blow. (Fig 2 & 3).

**Note:** We do not recommend creating tap holes additional to the part depth tap holes provided. Damage to the sink from attempting to create further tap holes will not be cover under warranty.

Fig 2.

Fig 3.

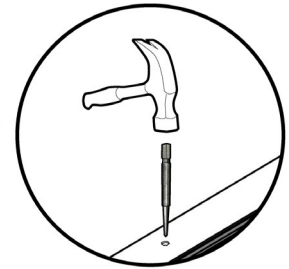
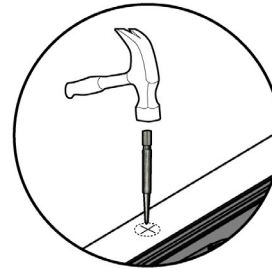

- Using the hammer and centre punch, **carefully** knock away the remaining ceramic to create the 35mm tap hole(s). (Fig4)

Fig 4.

Fig 5.

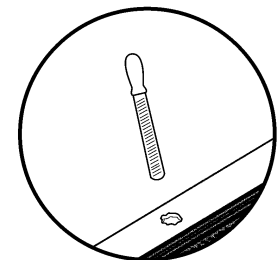
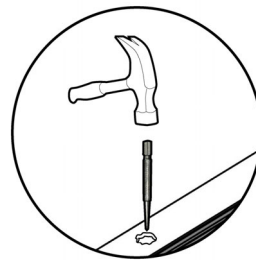

- Carefully file away any sharp edges around the tap hole(s) using a half round file. (Fig 5)

- Install the tap, waste kit(s) and overflow to the sink according to the manufacturer's instructions.

- Apply a generous continuous bead of silicone into the channel around the underside perimeter of the sink (Fig6).

Fig 6.

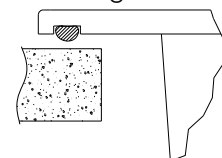

- Pass the sink through the worktop cut out from above, align the sink straight to the cut out hole and worktop front edge.

- Attach the sink connecting pipework to the waste kit(s) according to the manufacturer's instructions.

- You may choose to neatly seal around the sink outer perimeter using silicone, whilst the underside channel silicone bead should provide a watertight seal we recommend this step out of prudence.

### After installation

- Clean the sink ready for use using the attached care advice.
- Check the sink is flat to the worktop, straight and level; pour a small amount of water onto the drainer to check for drainage.
- Close the plug(s) in all bowls fill the sink with water below the overflow, check the water does not leak through or around the waste(s).
- Close the plug(s) in all bowls fill the sink with water above the overflow, check the water exits though the overflow and does not leak from the overflow system.
- Open the plug(s) and let water drain from the bowls, check the connecting pipework does not leak.
- If the sink is not to be used for a period after installation, cover the sink and tap to protect them from accidental damage during further surrounding installation work.
- We recommend that any water seals on this sink should be checked for water tightness periodically.