

THERMOSTATIC SHOWER PANEL

Shower
Panel Control
Handles and features
may differ depending
on Model



OWNER'S GUIDE

All images shown are for illustrative purposes only

ISSUE 02

These instructions cover Thermostatic Shower Panel Models

INTRODUCTION

This owner's guide shows you how to install, maintain and generally get the most from your thermostatic shower panel.

WE RECOMMEND INSTALLATION BY A QUALIFIED PLUMBER ONLY

TECHNICAL DATA

This shower panel is suitable for use on common types of plumbing systems including pumped, fully modulating combination boilers and high pressure unvented systems.

Minimum operating pressure 2 Bar

Maximum operating pressure 5 Bar

Important note: At static water pressures above 5 Bar, you must install a pressure reducing valve in the mains supply pipe set at 3 Bar static for optimum results.

As a guide to see if your water pressure is too high simply measure how many pints of water you get from your kitchen tap, with the cold side fully turned on. If you exceed 8 pints (or equivalent) in 30 seconds then you require a pressure reducing valve fitting to your incoming mains supply pipe, immediately after the stopcock to premises.

TEST DATA

These panels have been pressure tested to 15 Bar.

Before proceeding, please note:

1. The panel must be installed in compliance with local water authority byelaws and water supply byelaws.
2. Read all the instruction manual before proceeding.
3. Only begin the installation when you have all the necessary tools ready.
4. Please check that all the components are in the shower panel box.

AFTERCARE

When installing or using tools, extra care must be taken to avoid damaging the finish or the fitting. To maintain the appearance of this fitting, please ensure it is cleaned regularly using a clean soft damp cloth only. Abrasive cleaners or detergents must not be used as they may cause surface deterioration.

THERMOSTATIC SHOWER PANELS

This shower panel uses a wax thermostatic cartridge to maintain a constant shower temperature. The panel is **Anti Scald** and will automatically shut down the shower if the cold water supply fails. The panel itself is fitted with three **individual** controls, one to select the showering temperature, one to control the water flow, and one to select function (handset, fixed head etc). Once the flow control is turned on, the maximum showering temperature that should be achieved will be a factory pre-set 38°C at override position although this may vary with certain installations. You must ensure that the temperature of your **hot water supply is at least 60°C** for your shower to reach the maximum temperature.

STEP BY STEP INSTALLATION GUIDE

- Identify and check all the parts (**shower control handles and features may differ depending on model**).
- When positioning the panel, ensure you have sufficient pressure for an acceptable shower - 2 bar minimum.
- The **HOT** water feed must **always** be connected to the left inlet (as viewed from the front of the shower panel).
- Both hot and cold supply feeds must have **accessible isolator valves** fitted in-line for servicing purposes (not supplied).
- Refer to plumbing diagrams for further installation guidelines.

1. PRE INSTALLATION NOTES

PLUMBING DIAGRAMS

Key to symbols appearing throughout the Pre Installation notes:

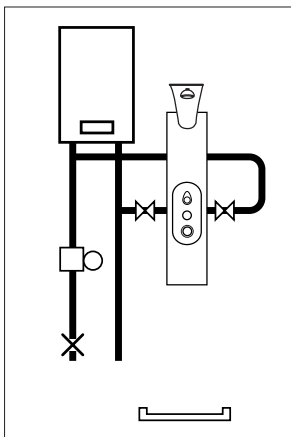
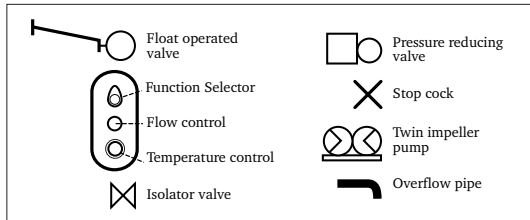

Gas Heated/Combi-Boiler Showers

The shower panel **must** be installed with a **modulating** type combi-boiler or multi-point gas heater. This system will produce a constant flow of water within the operating specifications of the appliance. NB The outlet temperature of the system **must** be capable of supplying hot water **in excess of 60°C**.

A pressure reducing valve may be required to ensure that cold water pressures do not exceed 5 Bar static.

N.B. Panel requires 2 bar minimum operating pressure.

1. PRE INSTALLATION NOTES (continued)

PLUMBING DIAGRAMS (continued)

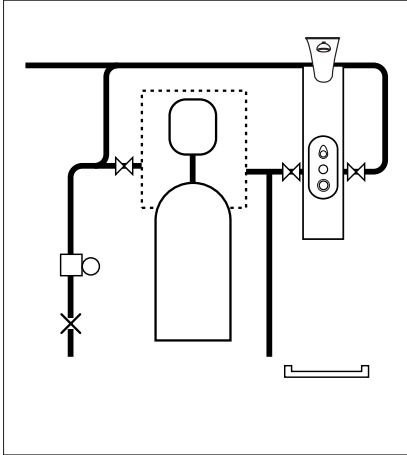

Unvented Mains Pressure Showers

The shower panel can be used on an unvented mains pressure system. This type of system **must** only be installed by a **competent person as per the requirement of Part G of Schedule 1 to the building regulations.**

For systems with no cold water take off after the heaters pressure reducing valve, an additional pressure reducing valve must be fitted, and set, at the same pressure as the heaters.

The water supply pressure to the shower panel must be between 2 and 5 Bar.

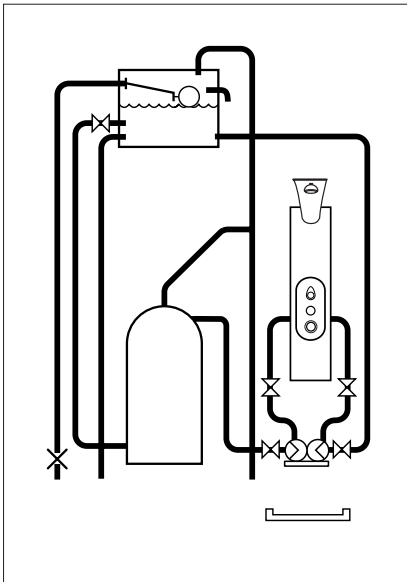

Pumped Showers

The shower panel can be used on a gravity fed pumped system. The use of a Surrey or Essex flange connection to the hot water cylinder will ensure an independent supply of hot water to the valve; this action will stop air being drawn into the system.

NB Please follow pump manufacturers' instructions relating to the siting and water feed details to the pump. Keep all pipework runs as short as possible for maximum shower performance.

N.B. Wherever possible 22mm pipework should be used to the pump. If non-return valves are fitted to the pump you should remove the ones from the valve inlets to avoid cavitation.

N.B. Panel requires 2 bar minimum operating pressure.

INSTALLATION INSTRUCTIONS

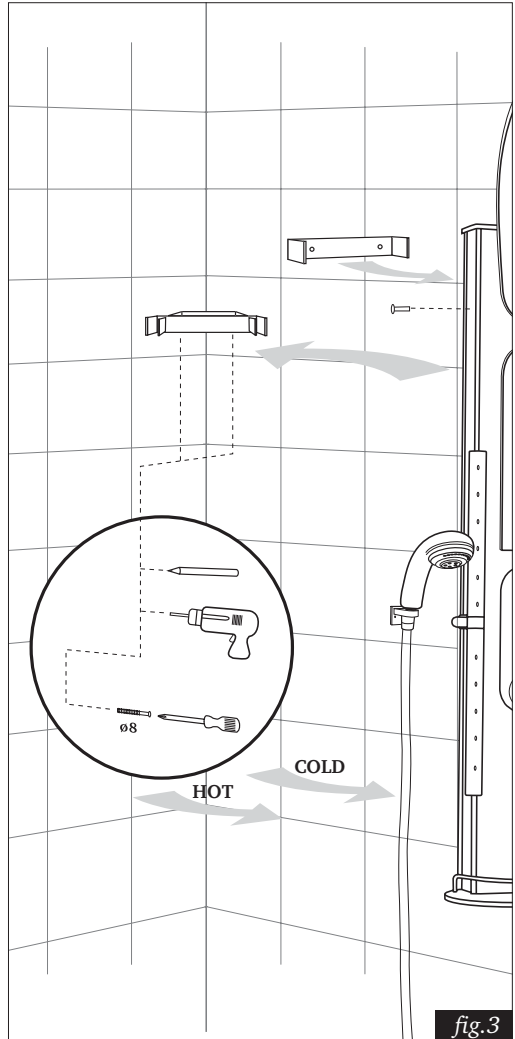
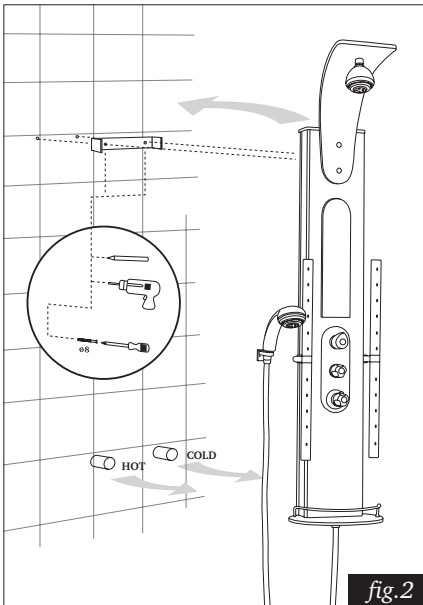
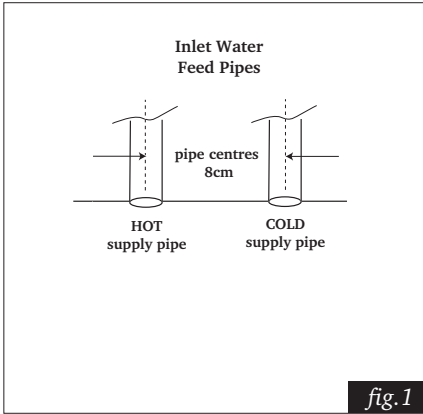

2. SITE & SHOWER PANEL PREPARATION (continued)

WALL MOUNTING - fig 1 & 2

1. Run the water feed pipes for the Hot & Cold water to the site of the panel- see Fig 1 for location dimensions.

Note: It is recommended where possible to use 22mm diameter water feed pipe, otherwise use 15mm diameter. The HOT water feed pipe MUST be sited on the left as viewed from the front - see Fig 1 & Fig 2.

2. Remove the Wall Bracket from the rear of the panel.
3. Determine the ideal height to fix the wall bracket. Mark the position, drill & secure the bracket.

Note: Specialised wall fixings may be required - not supplied.

4. Connect the Panel to the water supply pipes place a black rubber washer between tube & reducer, turn on water and check for leaks.

Note: Dependant upon the diameter of the water feed pipes installed at 1 above, either 22mm to 1/2" BSP or 15mm to 1/2" BSP reducers will be required to connect to the flexible water inlet tubes on the panel - reducers not supplied.

5. Position Panel against the wall and secure with the 2 off M5X20 screws (removed in 2 above) to the Wall Bracket and fit the 2 off securing screw hole blanking plugs.

Note: Care MUST be taken not to trap or severely twist the flexible Stainless Steel water feed pipes as this could obstruct the flow of water.

CORNER MOUNTING (NB not available on all models) - fig 1 & 3

1. Run the water feed pipes for the Hot & Cold Water to the site of the panel-see Fig 1 for location dimensions.

Note: It is recommended where possible to use 22mm diameter water feed pipe, otherwise use 15mm diameter. The HOT water feed pipe MUST be sited on the left as viewed from the front-see Fig 1 & Fig 3.

2. Determine the ideal height to fit the corner Wall Bracket. Mark the position, drill and secure the bracket- ensure that the notches are uppermost.

Note: Specialised wall fixings may be required - not supplied

3. Connect the Panel to the water supply pipes place a black rubber washer between tube and reducer, turn on water and check for leaks.

Note: Dependant upon the diameter of the water feed pipes installed at 1 above. Either 22mm to 1/2" BSP or 15mm to 1/2" BSP reducers will be required to connect to the flexible water inlet tubes on the panel-reducers not supplied.

4. Position Panel by hanging the Wall Bracket into the notches in the Corner Wall Bracket and fit the 2 off panel securing screw hole blanking plugs.

Note: Care MUST be taken not to trap or severely twist the flexible Stainless Steel water feed pipes as this could obstruct the flow of water.

3. TEMPERATURE SETTING & CALIBRATION

1.0 PRE-SET TEMPERATURE

- 1.1 The Panel temperature is pre-set at 38°C, but on certain installations the setting may need to be adjusted (termed calibrated)- See Calibration below.

2.0 CALIBRATION

- 2.1 Fully turn on the Panel water flow.
Note: Ensure the Hot water is above 60°C and you have more than 2 bar pressure.
- 2.2 Set the Temperature Control Knob/Lever (depending on model) at the 38°C position continue the operations below.
- 2.3 Remove the Central Cap/Lever (depending on model) & knob securing screw from the Temperature Control Knob/Lever.
- 2.4 Fully remove the Temperature Control Knob/Lever
- 2.5 Relocate the Temperature Control Knob/Lever approximately 3mm back onto the splined shaft.
Note: Hold in position
- 2.6 If the pre-set temperature is to Hot turn the Temperature Control Knob/Lever anti-clockwise to obtain the 38°C. Allow the temperature to stabilise for 10 seconds after each movement.
Note: If to cold turn the Temperature Control Knob/Lever clockwise to obtain the 38°C. Allow the temperature to stabilise for 10 seconds after each movement.
- 2.7 When set at 38°C carefully remove the Temperature Control Knob/Lever on the splined shaft aligning the 38°C (on the knob/lever) with the line n the fixed ring located on the panel.
Note: Ensure that the Knob/Lever is not rotated during this operation as the temperature will be altered.
- 2.9 Secure the Temperature Control Knob/lever with the fixing screw and replace the Centre Cap/Laver.

CLEANING PROCEDURE

CLEANING

1. Use the proprietary "daily shower cleaner/limescale remover" & if required a stiff brush e.g. nail brush.
Note: Ensure the cleaner/limescale remover will not cause damage to the decorative finish of the panel & its components.
2. Apply/spray the cleaner/limescale remover as directed on the product packaging to the spray nozzles.
3. If required using a stiff brush and a "stippling" motion clean the spray nozzles.
Note: The "stippling" motion will remove the external and internal (from the holes in the spray nozzles) staining/limescale.

CLEANING FREQUENCY

1. In "hard water" areas apply/spray the cleaner/limescale remover to the spray nozzles after every shower to ensure optimum performance of the panel.

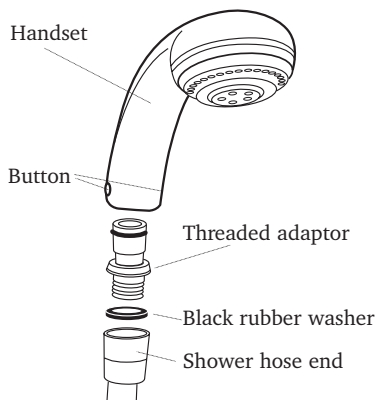
FIX HANDSET TO HOSE

Note: Depress both buttons simultaneously and pull out threaded adaptor

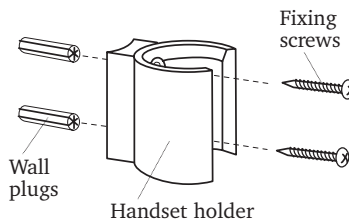
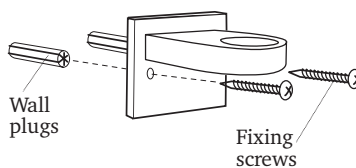
FIX HANDSET HOLDER TO WALL**FIX HOSE RETAINER TO WALL****4. ASSEMBLE FLEXIBLE SHOWER HOSE TO HANDSET**

1. Hold the handset, depress the two buttons at the threaded end of the handset simultaneously - pull the thread to remove the adaptor.
Note: It is normal for the Handset to "rattle" if shook the noise is the impeller which produces the aerated & pulsed spray patterns.
2. Place a black rubber washer in the "conical" end of the shower hose and screw on the adaptor removed from the handset-1 above.
3. Push the adaptor (& shower hose) into the handset ensuring the two buttons retain it.

5. FIX HANDSET HOLDER TO WALL

1. Ensure the holder is the correct way up i.e. to enable the conical end of the shower hose to locate.
2. Determine the ideal height to fix the Handset Holder. Mark the position drill and secure the holder.

Note: Specialised wall fixings may be required - not supplied.

6. FIX SHOWER HOSE RETAINER TO WALL

1. Determine the ideal height to fix the Hose Retainer i.e. at a position if the handset was dropped it would be clear of the tray. Mark the position, drill and secure the bracket.

Note: Specialised wall fixings may be required - not supplied.

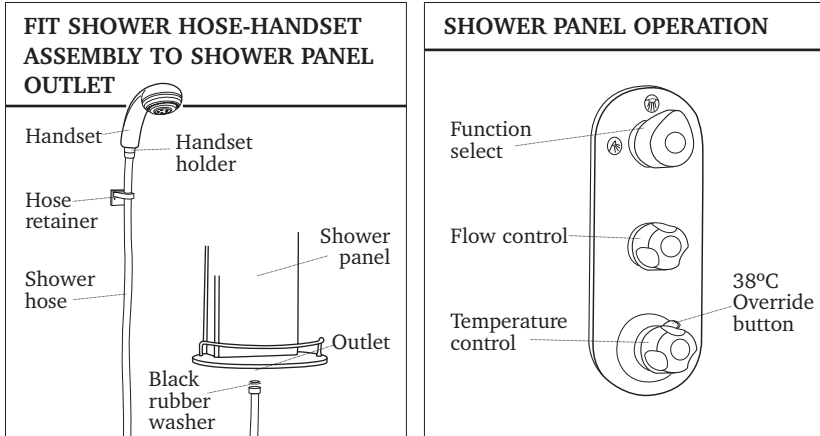

7. ASSEMBLE SHOWER HOSE & HANDSET ASSEMBLY TO SHOWER PANEL OUTLET

1. Feed the shower hose down through the hose retainer, place a black rubber washer in the end of the shower hose & screw onto the threaded adaptor in the base of the shower unit.

8. SHOWER PANEL OPERATION

1. The top control is the Function Control. By turning the control handle this directs the flow of water to the Handset, Fixed Head or the Rain-bars. Each relevant function is depicted by an icon/logo.
2. The centre control is the Water Flow Control. By turning the control handle anti-clockwise this will increase the water flow, clockwise to decrease and shut-off the water flow.
3. The lower control is the Water Temperature Control featuring an override button at the 38°C position. This temperature is require to be set at 38°C-see Section 3 Temperature Setting & Calibration for further information. When the Flow Control is opened fully the Temperature Control can be varied by turning clockwise for a Cooler shower or anti-clockwise for a Hotter shower up to the 38°C override button. Only by depressing this button and continuing to turn the handle anti-clockwise will the water temperature rise.

Note: Only one function will operate at any position.
Note: After showering at a temperature above the preset 38°C it is recommended for safety reasons to return the Temperature Control to or below the 38°C position.

4. Handset & Fixed Head spray pattern adjustment. By turning the outer ring a variety of patterns can be achieved from fine jet spray, aerated and pulsed patterns.

Note: The effectiveness of some of the spray patterns is dependant upon water pressure.

FAULT FINDING CHART FOR MINIMUM 2 BAR OPERATING PRESSURE

PUMPED SYSTEM	
FAULT	DIAGNOSIS
<i>"Showering temperature is not hot enough"</i>	<ul style="list-style-type: none"> • Ensure hot water supply is at least 60°C • Make sure you have equal pressures • Check for airlocks in pipework • Ensure there are no inverted 'U's in any of the pipework runs
<i>"Water goes cold during shower"</i>	<ul style="list-style-type: none"> • Insufficient hot water storage
<i>"When shower panel is set at cold, the showering temperature is too hot"</i>	<ul style="list-style-type: none"> • Hot and cold supply connections have been made in reverse - reconnect correctly
<i>Shower panel temperature is too hot</i>	<ul style="list-style-type: none"> • Turn down the flow of hot water from the pump using the in-line isolator valve

COMBI WITH 2 bar MINIMUM OUTPUT or OTHER HIGH PRESSURE SYSTEM	
FAULT	DIAGNOSIS
<i>"Showering temperature is not hot enough"</i>	<ul style="list-style-type: none"> • Incoming mains pressure exceeds 5 Bar - ensure you have fitted a pressure reducing valve in the mains supply pipe • Ensure hot water supply is at least 60°C
<i>"Shower panel is very noisy when in use"</i>	<ul style="list-style-type: none"> • Incoming mains pressure exceeds 5 Bar - ensure you have fitted a pressure reducing valve in the mains supply pipe immediately after stopcock to premises
<i>"The water goes cold whilst showering"</i>	<ul style="list-style-type: none"> • Ensure the boiler is still firing. Adjust the boiler to the hottest output, not the best flow
<p>NB Any product guarantees will be invalidated if the internal workings of the panel have been tampered with in anyway. Please call our HELPLINE if you are having any difficulties.</p>	

**If the Fault Finding chart does not remedy the problem, please contact the helpline immediately.
Telephone +44 (0)1422 417110.**