



Options Square

Thermostatic Bar Mixer Valve
with Riser Rail



Fitting Instructions

IMPORTANT!

This Step-by-Step guide should be retained after installation.

1. INTRODUCTION

This booklet contains all the necessary fitting and operating instructions for your MX Thermostatic bar mixer shower.

Please read these instructions carefully. Read through the whole of this book before beginning your installation.

The shower installation **MUST** be carried out by a suitably competent person in the sequence of this instruction book, after reading the instructions.

Care taken during the installation will provide a long and trouble free life from your shower. For the best performance within the specified running pressure range a minimum flow of 5 litres per minute should be available on both inlets.

This mixer valve is designed to operate on higher pressure systems up to a maximum of 5 bar running

pressure. The mixer valve must not be subjected to water temperatures above 80°C. This mixer valve is also suitable for thermal storage, unvented systems and pumped gravity systems.

IMPORTANT: Before installing with a gas instantaneous water heater, make sure it is capable of delivering hot water at a minimum switch-on flow rate of 3 litres per minute.

At flow rates between 3 and 8 litres per minute, the appliance must be capable of raising the water temperature to a minimum of 52°C.

The water temperature at the inlet to the mixer valve must remain relatively constant when flow rate adjustments are made (refer to the water heater operating manual to confirm compatibility with this mixer valve).

2. TOOLS REQUIRED (NOT SUPPLIED)

NOTE: Additional plumbing tools and fittings may be required.

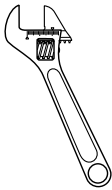

Spanner/Wrench

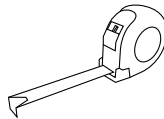

Tape Measure

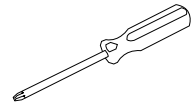

Screwdriver



Pencil

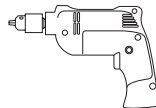

Power Drill



Suitable Drill Bits

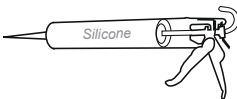

Silicone Sealant



Spirit Level



Safety Eyewear

3. PACK CONTENTS

Please make sure ALL components are included before starting the installation.

Description	Quantity
Bar Mixer Valve	1
Handset	1
Riser Rail	1
Riser Rail Fixing Brackets	2
Handset Height Adjuster	1
Soap Dish	1
1.25m Hose + Washers	1
Dogleg Thread Adaptors	2
Nut Covers	2
Hose Retaining Ring	1
Filter Washers	2
Pressure Balance Kit	1
Screw Pack (2 screws + 2 plugs)	1
Fitting Instructions	1
TMV Registration Card	1

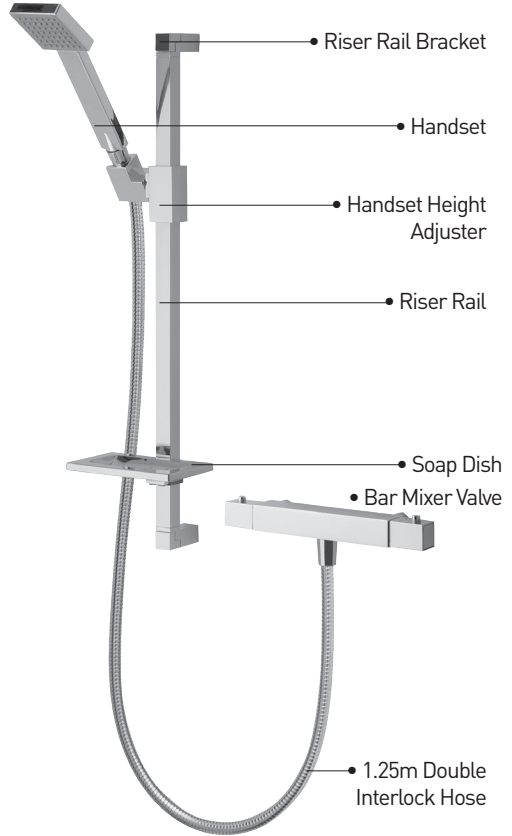

Dogleg Thread Adaptor

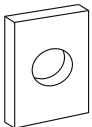

Nut Cover



Hose Retaining Ring



Filter Washer

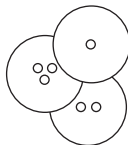

Pressure Balance Kit

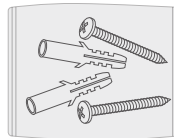

Screw Pack

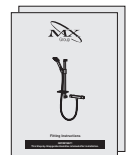

Fitting Instructions and
TMV Registration Card

4. PLEASE READ THIS IMPORTANT SAFETY INFORMATION

Products manufactured by the MX Group are safe and without risk provided they are installed, used and maintained in good working order in accordance with our instructions and recommendations.



Layout and sizing of pipework **MUST** be such that when other services are used, pressures at the shower control inlets do not fall below the recommended minimum.



DO NOT choose a position where the shower could become frozen.



DO NOT connect this mixer valve to any form of tap or fitting not recommended by the manufacturer.

Conveniently situated service valves in each inlet supply **MUST** be fitted as an independent method of isolating the shower should maintenance or servicing be necessary, these valves **SHOULD NOT** restrict the flow.



DO NOT operate the shower outside the recommended temperatures and pressures stated in this guide.

Always test the water temperature with your hand before entering the shower.



NOTE: As a competent person installing this shower you should ensure that all users are very conversant in its operation.

The British Burns Association recommends 37°C to 37.5°C as a comfortable bathing temperature for children. In premises covered by the Care Standards Act 2000, the maximum mixed water outlet temperature is 41°C.



Metal surfaces on the hot supply may become hot during operation.

Arrange to have the mixer valve regularly serviced by a suitably qualified person.

The handset must be regularly cleaned to remove scale and debris.

5. SITE REQUIREMENTS

The installation must be in accordance with Water Regulations Advisory Service (www.wras.co.uk).

Minimum running water pressure: 0.1 bar, but will operate better at a minimum of 0.5 bar.

Maximum running water pressure: 5 bar. Maximum static water pressure: 10 bar.

For your shower to perform well you should ensure that the pressure is as specified and a minimum flow of 5 litres per minute is available at both hot and cold inlets.

If the water supply is fed by a gravity system then the supply pressure should be verified to ensure the conditions of use are appropriate for the valve.

NOTE: Water Regulations requires the handset to be 'constrained by a fixed or sliding attachment so that it can only discharge water at a point not less than 25mm above the spill over level of the relevant bath, shower tray or other fixed appliance'. A double check valve, or similar, MUST be fitted in the supply pipe work to prevent back-flow.

The pressure at both the hot and cold water supplies to the mixer valve should be the same, and the installer should ensure that the flow is not

6. SITING OF THE MIXER VALVE

Position the mixer valve so that all controls can be comfortably reached whilst using the shower.

The height of the showerhead should suit all user's requirements. When suspended from the hose retaining ring, the showerhead should be a minimum of 25mm above the spillover level of the bath or shower tray.

NOTE: Easily accessible suitable service valves (complying with Water Regulations Advisory Service www.wras.co.uk), MUST be fitted as close as practical to the valve, on the hot and cold water supplies to the shower as an independent means of isolating the water supplies should maintenance or servicing be necessary. These valves should not restrict the flow.

affected by other taps elsewhere in the house. It is very important that for use in any mains pressure systems an expansion tank and a pressure reducing valve has been fitted to ensure the pressure does not exceed 5 Bar.

This should be confirmed by the installation engineer or competent person before installation.

WATER TEMPERATURE REQUIREMENTS

Maximum hot water temperature = 80°C,
Recommended maximum = 65°C.

Minimum hot water temperature = 55°C

Maximum cold water temperature = 20°C

TEMPERATURE ADJUSTMENT RANGE

The mixed water temperature can be adjusted from cold through to hot. There is a safety stop preset at a set temperature of about 38°C. Always test the water temperature prior to using the shower.

In the event of failure of cold water system, the mixer valve automatically reduces the flow of hot water to prevent scalding. It will only operate again once the flow of cold water has been resumed.

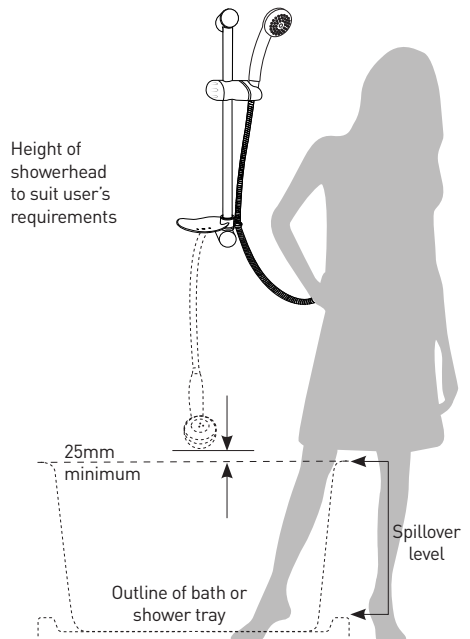

7. IMPORTANT INSTALLATION INFORMATION

Before proceeding with the installation check all the components in the component list are present.



WARNING!

The shower **must not** be positioned where it will be subject to freezing conditions.

The mixer valve should be fitted only after all the pipework has been installed. Isolating valves should be fitted to both hot and cold water supplies for servicing purposes.

DO NOT modify or use jointing compounds on any of the pipe fittings. **DO NOT** solder fittings near the mixer valve as heat can damage the valves seals. Always flush the system prior to installing the valve.

Before installing, make sure the mixer valve is kept in a clean place to prevent any debris getting into the openings while fitting the pipework.

■ The mixer valve is suitable for installation on a solid wall, a stud partition wall, dry lined wall or fixing to a cubicle or panel.

■ The water pipes should be securely attached within the wall or panel to support the mixer valve and prevent movement or water noise after installation.

■ The mixer valve hot water inlet has a red symbol next to the inlet and must be on the left hand side. If the mixer valve you are fitting is with a riser rail the

outlet should point down, if the mixer valve is for an overhead the outlet should point upwards.

■ The mixer valve is designed to work at the same hot and cold water pressures. If this is not the case a flow controller (disc with small holes) can be fitted to the higher pressure supply to the valve. This is best done by testing each one to find out which gives the best results.

■ The mixer valve will be installed in such a position that the maintenance of the TMV and its valves and the commissioning and testing of the TMV can be undertaken.

Before fitting the mixer valve flush out the pipework in accordance with Water Regulations Advisory Service (www.wras.co.uk).

The MX Options range of thermostatic mixer valves is suitable for use with the following systems:

Gravity Fed, Gas Combination Boiler, Pumped Gravity, Mains Pressure (Thermal Store), Unvented Systems.

NOTE: On gravity systems the minimum distance from the underside of the cold water storage tank to the shower head must be 1 metre.

8. PRESSURE BALANCING (IF SUPPLIED)

The thermostatic mixer valve is designed to work best when the feed pressures of both hot and cold water are the same. If there is a difference in pressure it will cause the flow of water through the valve to pulse rather than being a steady flow. This pulsing can be reduced by putting one of the metal disks with holes into the higher pressure feed to the valve. This restricts the flow and reduces the pulsing.

To maximise the volume of water through the valve the disk with the most holes should be tried first. If this does not work the others should be tried until a satisfactory result is obtained.

If the water pressures to hot and cold are the same these disks do not need to be used.

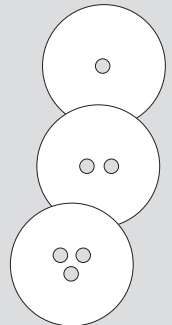

9. FITTING THE MIXER VALVE

IMPORTANT: Ensure that you have read through section 7. IMPORTANT INSTALLATION INFORMATION before starting to fit the mixer valve.

1. The supply pipework can be plumbed from above or below but must finish with suitable connections, which should be at 150mm centres. A standard Easy Fit Kit can be purchased to make installation easier if required. Connect the 15mm pipework using standard compression fittings (Fig 1).
2. Screw the supplied nut covers onto the dogleg fittings until tight to the wall. If required put a bead of silicone sealant around the inside of the cover to prevent moisture entering the wall. The nut covers can be adjusted depending on the length of exposed thread from the elbow (Fig 2).
3. Offer the mixer valve to the fittings, making sure the sealing washers are in place, screw the unions onto the fittings. The mixer valve must be positioned horizontally with the hot supply on the left hand side of the outlet (Fig 3).

NOTE: Ensure you have the correct valve with the water outlet on the bottom when the hot water inlet is to the left.

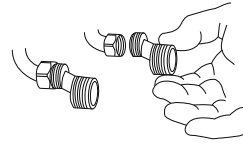

1

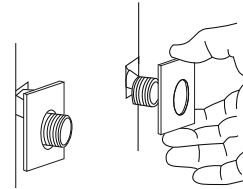

2

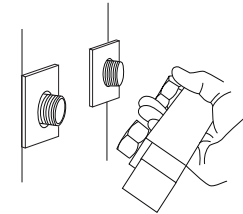

3

10. FITTING THE RISER RAIL AND HANDSET

1. Having established the position of the mixer valve so that all controls can be comfortably reached whilst using the shower, the handset can be positioned either side of the riser rail (Fig 4).
2. Remove caps for the riser rail wall brackets, mark the position of the holes and drill, plug and screw to fit the two wall brackets. Fix lower bracket to wall (Fig 5).

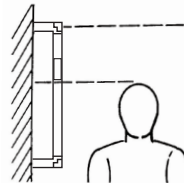

4

✓ TIPS

- A piece of insulating or masking tape applied to the wall before marking out the fixing holes will help stop the drill from wandering, particularly on tiled surfaces.

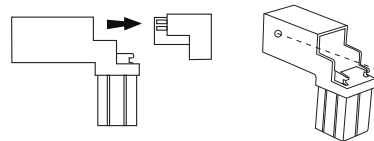

5

⚠ CAUTION ⚠

Check there are no hidden cables or pipes before drilling holes for wall plugs.

Exercise great care when using power tools near water.

The use of a residual current device (RCD) is recommended.

10. FITTING THE RISER RAIL AND HANDSET (CONT.)

3. With the handset height adjuster on the left hand side, fit the soap dish and then the hose retaining ring, onto the bottom of the rail assembly (Fig 6).
4. Replace the rail assembly onto lower bracket. Fix the top bracket to wall and then loosen lower bracket and fit rail into top bracket ensuring the slot locates into the notch and retighten the lower bracket. Refit caps onto brackets.
5. Connect one end of the double interlock hose to the outlet on the mixer valve, making sure that the sealing washer is in place (Fig 7).
6. Screw the remaining end of the double interlock hose to the handset, then locate the handset into the handset height adjuster making sure the sealing washer is in place (Fig 8).

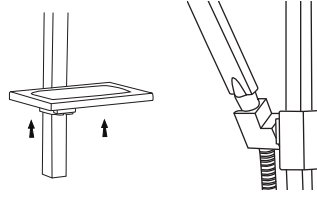

6

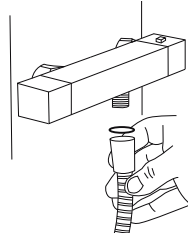

7

NOTE: It is the conical end of the double interlock hose which grips into the handset height adjuster. The handset will not fit in the height adjuster without the double interlock hose attached. The handset height adjuster grips the conical nut on the double interlock hose.

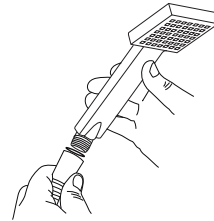

8

11. OPERATION

There are 2 control handles on the mixer valve.

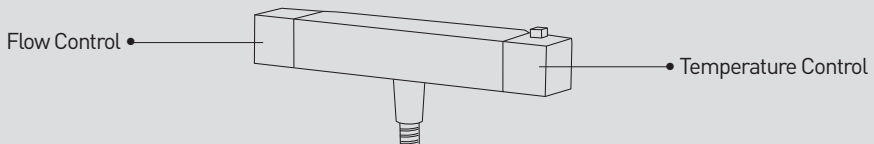

TO CONTROL THE FLOW

Turn the left control handle anti-clockwise to turn on and increase the flow. Turn clockwise to decrease and turn off.

TO CONTROL THE TEMPERATURE

On the temperature control a numbered dial indicates the direction for hot and cold flow. Turn anti-clockwise for hot and clockwise for cold.

If in operation an increase in temperature above the factory set temperature is required, simply depress the stop button on the temperature handle when it reaches the stop and continue to turn the handle anti-clockwise until the desired temperature is found.

12. COMMISSIONING AND ANNUAL MAINTENANCE TESTING

Before commissioning the following checks and tests need to have taken place:

- All the pipe work has been flushed through before fitting the valve and there are no leaks.
- The supply pressures and temperatures are checked and all are in the range specified in these instructions.
- The isolation valves and strainers are fitted and clean of any unwanted material and do not restrict flow.
- The valve has been fitted to the pipework with all connections correctly tightened.

COMMISSIONING PROCEDURE

1. Ensure both isolation valves are fully open. Turn the temperature control to cold and turn the flow on.

Check the temperature is at the required minimum.

2. Rotate the temperature controller gradually until it reaches the preset stop. Let it flow until the hot water has reached the valve and the temperature has stabilized.

Check the temperature is 38°C +/-2°C.

This is the factory preset. If the valve does not operate properly check and confirm that the hot and cold water supplies are fitted to the correct inlets.

3. Override the temperature stop button by pressing the button and rotate to maximum being careful to avoid scalding.

Measure the temperature.

4. The valve should then be checked to confirm the water isolation performs correctly. Run the valve at the 38°C stop position.

Check the water temperature.

5. Turn off the feed of cold water using the isolation valve.

The water flow should fall to a very low flow, (possibly only a drip) after a few seconds.

6. Collect the water after 5 seconds and 30 seconds. **Measure the temperature – it should be below 46°C +/- 2°C .**

7. Turn on the cold water again and it should return after a few seconds to stabilise to 38°C +/- 2°C.

TEMPERATURE SETTING ADJUSTMENT

NOTE: Adjustment of the temperature settings is only to be carried out by a competent TMV engineer as it is a technically difficult operation in which the valve can easily be broken.

1. Remove the handle on the temperature controller, (noting carefully the assembly of the components).
2. Rotate the internal stops a few degrees in the required direction.
3. Reassemble.
4. All the commissioning checks should be done again to ensure it now meets the required specification before using the shower.



Before use, ensure that you instruct all users in the safe operation of the shower as outlined in this document.

13. TROUBLESHOOTING AND FREQUENTLY ASKED QUESTIONS

If the performance of your shower deteriorates in service please follow the self help items detailed below before seeking professional advice from the installer. If the actions below fail to restore the shower performance you should initially contact the person or company that installed the shower.

Q. Water too HOT.

A. Six possible reasons:

- 1. Temperature control is not correctly commissioned.**
Adjust the temperature control - this is only a job for a suitably qualified person.
 - 2. Not enough cold water flowing through shower.**
Turn temperature control anti-clockwise.
 - 3. Increase in the ambient cold water temperature.**
Turn temperature control anti-clockwise.
 - 4. Cold water supply blocked.**
Turn off shower and consult a competent plumber.
 - 5. High volume of cold water drawn off elsewhere.**
Reduce the simultaneous demand from the supply.
 - 6. Cold water filter blocked.**
Remove valve and clean filters.
-

Q. Water does not flow or shower pattern collapses when another outlet is turned on.

A. Check the following:

- 1. Water supplies cut off**
Check elsewhere in house and if necessary contact local water company.
 - 2. Blockage in pipework.**
Turn off shower and consult a suitably competent plumber.
 - 3. Valve filters blocked by debris in water supply.**
Remove valve and clean filters.
 - 4. Showerhead blocked.**
Clean Showerhead.
 - 5. System not capable of supplying multiple outlet at the same time.**
Reduce simultaneous demand. Check stop/service valves are fully open. Check if enough water pressure.
-

Q. Water too COLD.

A. Nine things to check:

- 1. Temperature control is not correctly commissioned.**
Adjust the temperature control - this is only a job for a suitably qualified person.
 - 2. Not enough hot water flowing through shower.**
Turn temperature control clockwise.
 - 3. Hot and Cold supplies connected the wrong way round.**
Change water feed supply so that the hot water is going to the feed marked with a red dot.
 - 4. Decrease in the ambient cold water temperature.**
Turn temperature control clockwise.
 - 5. Hot water filter blocked.**
Remove valve and clean filters on the inlet.
 - 6. Insufficient hot water supplies from the heating system.**
Make sure the hot water is available by trying a hot water tap elsewhere in the house.
 - 7. Hot water supply blocked or restricted.**
Make sure the hot water is available by trying a hot water tap elsewhere in the house.
 - 8. Pressure in excess of max recommended.**
Turn off shower and consult a suitably competent plumber.
 - 9. Combi boiler may need the correct pressure/flow setting to start heating water when the valve is turned on.**
Contact your boiler supplier.
-

Q. Shower controls noisy whilst in use.

A. Running pressure in excess of maximum recommended – fit reducing disc to outlet of valve.

Q. Shower will not shut off.

A. Flow control cartridge worn – renew flow control cartridge.

14. THE MX GROUP 1 YEAR REPLACEMENT GUARANTEE

Marleton Cross Limited (MX Group) hopes you are satisfied with your purchase and in the unlikely event that you encounter a problem which is caused exclusively by the MX Group manufactured product (the "product") we will take responsibility on the terms set out here.

We aim to supply products, which have been manufactured to the highest standards. In respect of the product you have a one year replacement guarantee which covers any defect in manufacture. Any part found to be defective during the guarantee period will be replaced without charge providing that the product has been installed in accordance with our instructions, used as intended and maintained/serviced as recommended.

In the unlikely event that any problems are encountered with this product's performance on installation, please contact our Customer Care Department for help, as below. Please supply proof and date of purchase when contacting MX Group.

The company reserves the right, in the event of a claim not covered by the guarantee, to charge the claimant for parts and labour at current rates. This guarantee is given in addition to and does not affect your statutory rights.

1. Any product found to be defective during this period, as the result of misuse, neglect or damage, will not be covered by this guarantee such as:

- Damage caused by accident
- Those products subject to wear and tear such as 'O' rings and washers etc.
- Effects of scaling
- Damage caused by faulty installation.
- Damage caused by waterborne debris.
- Damage caused by improper cleaning products.
- The products being used for a purpose other than intended.

2. Breakdown due to:

- a) Use other than domestic use by you or your resident family
- b) Wilful act or neglect
- c) Any malfunction resulting from the incorrect use or quality of water or incorrect setting of controls; and
- d) Faulty installation.

3. Repair costs for damage caused by foreign objects of substances or the inappropriate use of jointing compounds or blow torches.

4. Total loss of the product due to non-availability of parts or other reason, (MX Group will maintain stocks of spare parts for repair for at least 5 years from end of product line to cover this guarantee).

5. Compensations for loss of use of the product or consequential loss of any kind.

6. Call out charges where no fault has been found with the appliance.

7. The cost of repair or replacement of pressure relief devices, showerheads, hoses, riser rails and/or wall bracket, tiles, cubicles or any other parts installed at the same time.

8. The cost of routine maintenance, adjustments, overhaul modifications or loss or damage arising there from, including the cost of repairing damage, breakdown, malfunction caused by corrosion, furring, pipe scaling, limescale, system debris or frost.

9. Products and/or units including products purchased and installed other than in the United Kingdom.

Limitations

1. This guarantee lasts for a single continuous period of 12 months from the date of delivery to you the customer.

2. This guarantee is personal to the original purchaser of the product and is not transferable.

3. Original proof of purchase(s) must be shown for any claim under this guarantee.

4. This guarantee does not cover any products that have been modified, altered or transformed in any way.

5. This guarantee applies to an original installation in accordance to our fitting instructions and does not cover previously installed products (showroom displays etc) or products that have been moved from their original installation position for any reason.

6. This guarantee applies only to manufacturing or material defects. It does not apply to normal wear and tear, accidental damage, inappropriate use (including inappropriate cleaning) or other events outside the manufacturer's control.

7. This guarantee applies only to the product itself and as a result any liability attributed to MX Group is limited to the cost of the product.

8. If a product is deemed to be of faulty manufacture MX Group will at their discretion replace the product. Any related consequential loss or damage is excluded.

9. No claim will be accepted if a product is installed with a fault (ours or otherwise) that would have been clearly evident before installation.

10. We make no representations, and exclude any and all liability, in respect of any third party products or services supplied by way of extensions to this guarantee.

Liability

1. Except as required or agreed by us, you will not in any circumstances return any of the product to us, and where the property in any of the goods returned to us has passed to you, they will nevertheless remain your property and at your risk unless we have agreed otherwise in writing before their return.

2. Except as stated above, we will not be liable for any direct, consequential or other loss, damage or injury suffered or incurred by you, and you will indemnify us fully against any claims made by third parties, in respect of the goods or otherwise arising from the contract.

3. Nothing contained in the contract will be treated as excluding or restricting any liability on our part for death or personal injury resulting from our negligence.

4. Except as stated above, and to the fullest extent permitted by law, all conditions, warranties and representations, whether express or implied, statutory or otherwise in relation to the product (other than such as relate to title to the product) are excluded

5. You acknowledge that our prices for the goods reflect these Terms and Conditions, and accordingly that you accept the above limitations on and exclusions of liability in exchange for those prices

6. When providing information to MX-Group you understand that you are doing this subject to our terms and other policies (including data protection) we have in place from time to time, copies of which are available on our website www.mx-group.com or on request as per the MX Group contact details given herein.

7. This guarantee does not affect your statutory rights.

In the interest of continuous product development we reserve the right to alter the specification as necessary. In the unlikely event that you need to make a claim on our guarantee please contact MX customer care on 0845 505 2211 or email us at sales@mx-group.com.

15. SERVICE POLICY

In the event of you needing to contact the MX Group Customer Service Department, the following procedure should be followed:

1. Before telephoning on 0845 505 2211 the MX Group Customer Service Department you should ensure you have the model number (printed on the valve), the date and proof of purchase, your contact details and the postcode where the unit is installed.
2. The MX Group Customer Service Department will be able to tell you whether the fault can be simply rectified by the provision of a replacement part.

16. SPARE PARTS

In the event that parts or maintenance is needed outside the guarantee MX will endeavour to help with this. Spare parts codes are given in the fitting instructions. By calling the Customer Service Department on 0845 505 2211 with the part number, they will be able to quote you to supply these parts, usually via our spares distributor.

Customer Care Department

Telephone: 0845 505 2211

9.00am - 5.00pm Monday to Friday

6754A KL/JULY2016



Marleton Cross Limited Trading as The MX Group

Alpha Close, Delta Drive, Tewkesbury Industrial Estate, Tewkesbury, Gloucestershire GL20 8JF
Tel: 01684 293311 Fax: 01684 293900 Email: sales@mx-group.com www.mx-group.com

CUSTOMER CARE: 0845 5052211

TRADE DESCRIPTIONS ACT

Variations in terms of colour finish, materials and all other aspects of appearance may occur on occasions, either through non-availability of materials or due to our policy of continuing technical improvement. Therefore the Company reserves the right to change specification or withdraw products from this list without prior notice being given.