

## ERQ - QUADRANT ENCLOSURE (Note this is a 2 person assembly)

1. Fit the shower tray ensuring it is level across all areas. (Fig 1)  
2. Apply silicone sealant to the edges of the tray after tiling. (Fig 2)  
3. Take the wall channel (A) and position 10mm from the front edge of the tray. Ensure the wall channel is plumb and mark the fixing positions. Drill the wall with the appropriate drill bit for the wall plugs supplied (x8), taking care to avoid any hidden pipes or electrical cables. (Fig 3)

4. Fix the wall channels with appropriate screws. (not supplied)  
5. Sit the vertical profile (B) into the bottom curved profile (H) and screw through the vertical profile using the 30mm Screws as in Fig 4. (x2)  
Note! It is recommended that 2 people carry out this operation.  
6. Fix the vertical profile at the opposite end to the bottom profile at this stage.  
7. Repeat this for fixing the top curved rail (H) as in Fig 5.  
8. Fit the glass side panel (D) into vertical profile, then fit the single seal (C) on the inside between the glass and vertical profile as in Fig 6.

9. Fix the glass clamps (x4) and wheel stops (x8) into the pre-drilled holes in the top and bottom rail with 10mm screws (Fig 7). Refer to the diagram below for the positioning and orientation of the wheel stops & glass clamps.  
10. Ease the built-up enclosure into the wall channels. Adjust by easing the enclosure in or out of the fixed wall channels, to follow the shape of the shower tray. (Fig 8)  
12. Drill through the wall channel on the inside of the enclosure with a 3mm drill bit approx 100mm from the top & bottom. Then screw together using the 10mm screws (x4) as in Fig 9.

13. Fit the double wheels into the pre-drilled holes (x4) in the curved glass doors (F), by tightening the pre-inserted screw. (Fig 10)  
14. Fit the quick release wheels (x4) to the opposite end, again by tightening the pre-inserted screws. (Fig 11)  
15. Hang the doors onto the top rail making sure that the wheels are located in the channel. Then from the outside push down on the spring loaded wheels and clip into position. (Fig 12)  
Adjust using the adjustment screws as required.  
16. Finish by fitting the handles supplied.

Fig 1



Fig 2



Fig 3



Fig 4



Fig 5

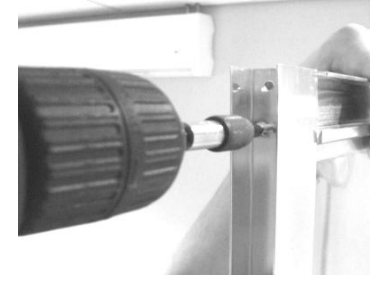

Fig 6



Fig 7



Fig 8



Fig 9



Fig 10



Fig 11

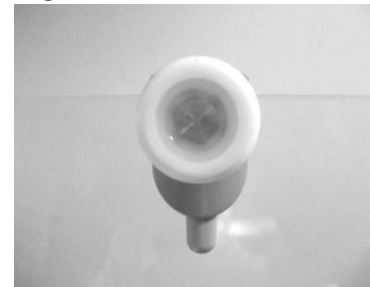

Fig 12



17. Fit the magnetic jointing strips (G) to the edges of the curved doors. Also fit the vertical seal (E) at this stage to the opposite edges of the curved doors. (Fig 13)

18. Apply silicone down the vertical edges of the wall channel, fixed glass panel, curved profile and the bottom edge of the fixed glass panel. (Fig 14/15) A seal is provided for the bottom edges of the fixed glass panel if preferred. Cut to length as required.

**DO NOT SEAL THE ENCLOSURE ON THE INSIDE OF THE TRAY!**

Fig 13













Fig 14



Fig 15



FITTINGS LIST		
	10mm SCREWS	16
	20mm SCREWS	4
	30mm SCREWS	14
	WALL PLUGS	6
	GLASS CLAMP	4
	GLASS SEAL ('T' SHAPED)	1
	WHEEL STOPS	8
	DOUBLE WHEEL	4
	QUICK RELEASE WHEEL	4
	SHOWER DOOR HANDLE	4

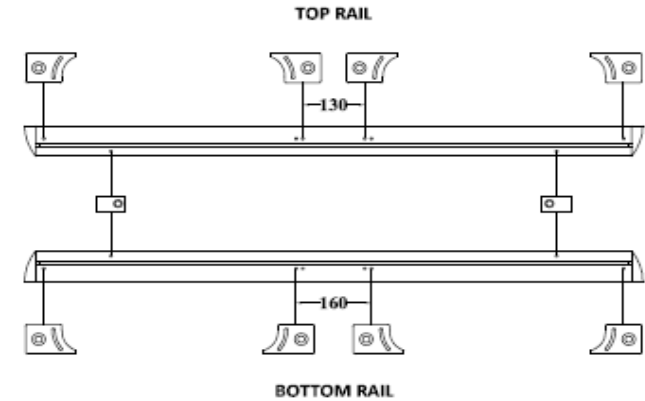
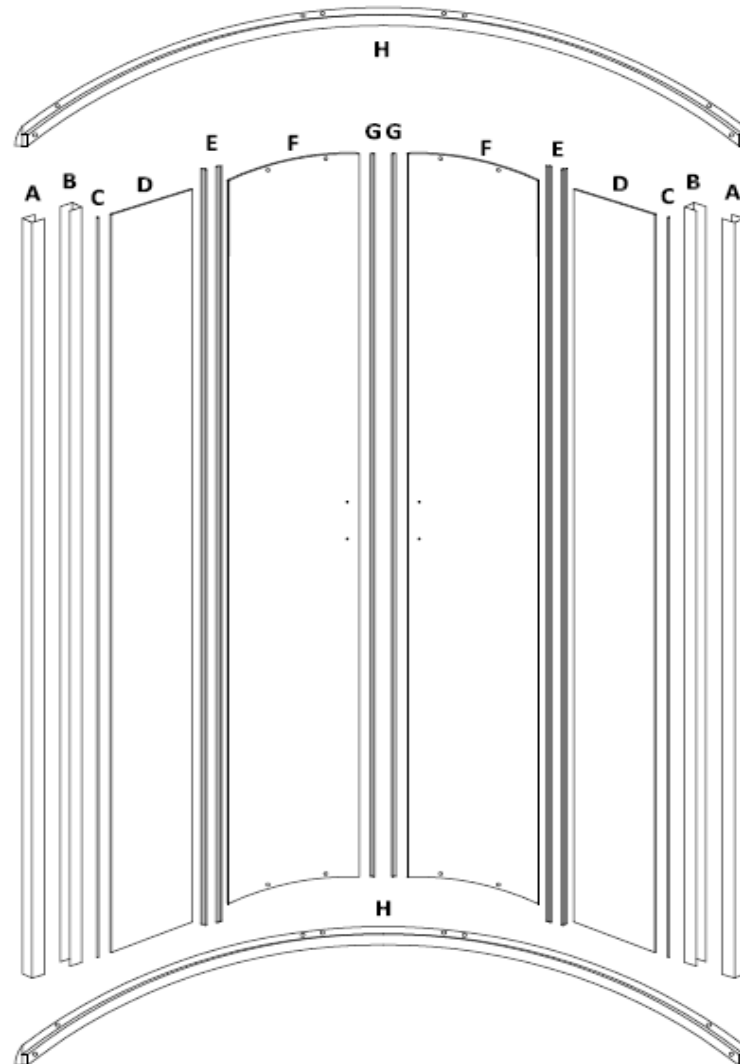

PARTS LIST	
A	WALL CHANNEL (x2)
B	VERTICAL PROFILE (x2)
C	SIDE PANEL SEAL (x2)
D	GLASS SIDE PANEL (x2)
E	GLASS DOOR SEAL (x4)
F	CURVED GLASS DOOR (x2)
G	MAGNETIC STRIP (x2)
H	CURVED RAILS (x2)