

## ERBD - BI FOLD DOOR ENCLOSURE (Note this is a 2 person assembly)

1. Fit the shower tray ensuring it is level across all areas. (Fig 1)

Fig 1



2. Apply silicone sealant to the edges of the tray after tiling. (Fig 2)

Fig 2



3. Take the wall channels (A) and position them 10mm from the front edge of the tray making sure they are vertical and plumb. Mark the fixing positions and drill for the wall plugs (x3) with an appropriate drill bit. Fit the wall plugs. Take care to avoid any hidden pipes or electrical cables. (Fig 3)

Fig 3



4. Slide the wall channels onto either side of the Bi-Fold Door frame (Fig 4) carefully lift the frame into position and fix to the wall using the 30mm screws.

**NOTE! The Bi-Fold Door is reversible so the door opening can be LH or RH.**

Fig 4

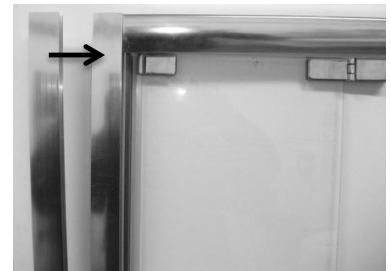

5. Once aligned, drill x2 holes 150mm from the top & bottom on the inside of the enclosure with a 3.2mm drill bit, through the wall channel and frame (Fig 6). Secure by using the 10mm screws making sure the support cups are used. Fit the handle supplied.

Fig 5



6. Apply silicone down the vertical edges of the wall channel and along the bottom edge of the Bi-Fold Door frame (Fig6).



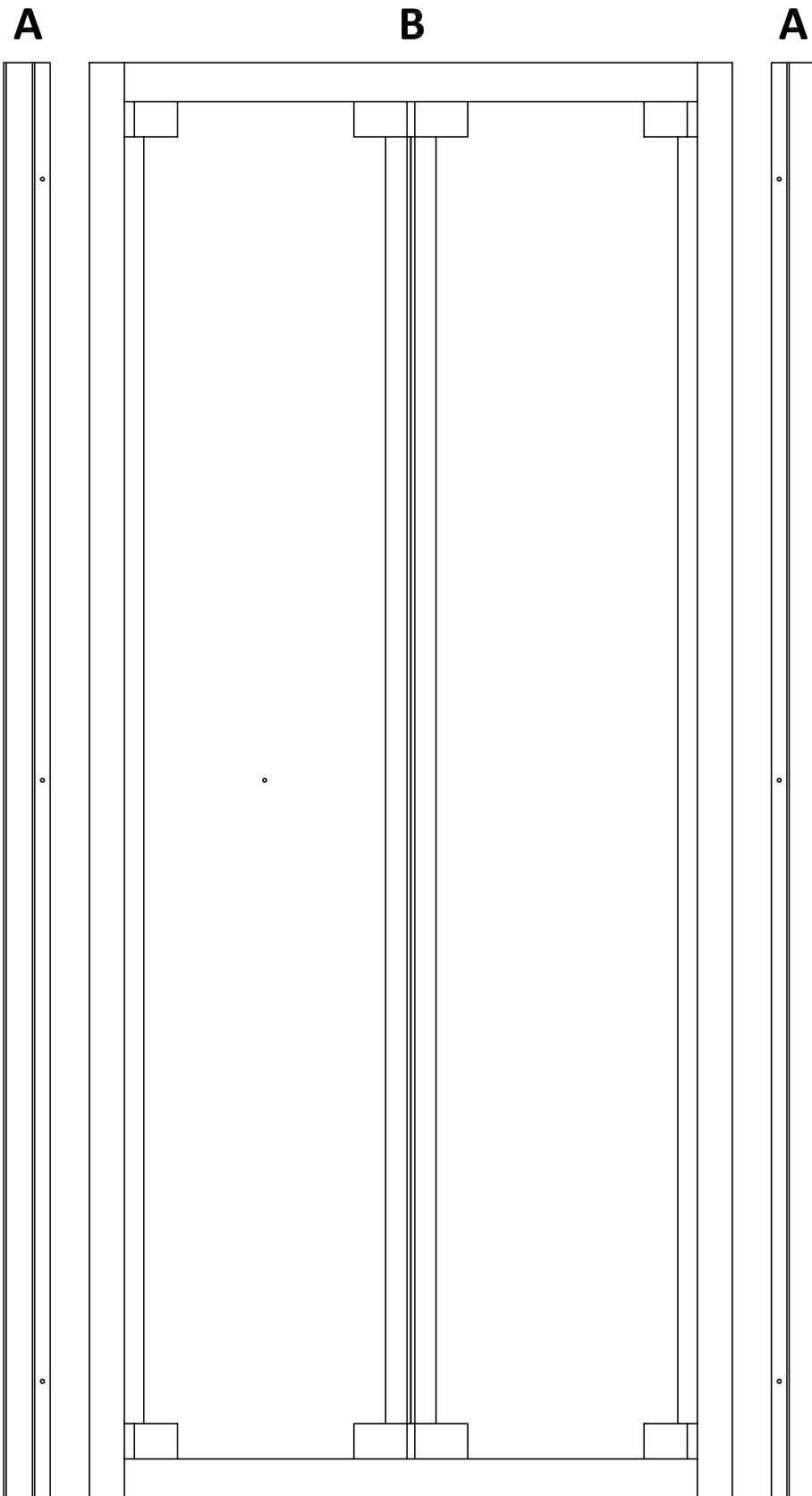

**DO NOT SEAL THE ENCLOSURE ON THE INSIDE OF THE TRAY!**

Fig 6



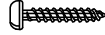
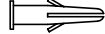

PARTS LIST		
A	WALL CHANNEL	2
B	BI-FOLD DOOR FRAME	1

FITTINGS LIST		
	10mm SCREWS	4
	30mm SCREWS	6
	WALL PLUGS	6
	INNER SUPPORT CUPS	10
	SCREW COVER CAP	10
	HANDLE	2

WHEN THIS ENCLOSURE IS TO BE FITTED WITH A SIDE PANEL, REFER TO THE SIDE PANEL INSTRUCTION IN CONJUNCTION WITH THESE.

# PEARLSTONE

## SHOWER TRAY FLAT TO FLOOR INSTALLATION

### **Pearlstone Shower Tray installation onto a timber floor.**

It is recommended that all flat top shower trays are installed before tiling to ensure that the top radius of the tray is behind or at least below the tile face. This will help to create a water tight seal. (see diagram overleaf)

Carefully lower the tray into the chosen position, then mark the floor for the waste opening. Remove the tray.

Check below the floor level to ensure that there is adequate access for the waste and pipe work. If an obstruction is found, drill a hole and make provision in the floor of a sufficient diameter to allow the entire waste coupling to fall below the floor level.

Make sure the floorboards are securely fixed. If this is not possible, use 18/20mm thick green grade chipboard, cut to the size of the tray and fix in place.

**Caution!!** Before attempting to secure any loose floorboards or the chipboard to the floorboards, check that there are no pipes or electrical connections beneath the floor level.

Seal the installation area with a suitable clear waterproofing agent.

Fit the waste and trap to the tray. It is recommended that you use a suitable silicone sealant around the waste to create a watertight seal.

Ensure that the entire base of the tray is fully supported. The tray has to be FULLY COVERED with a 5mm minimum thickness of weak cement mix. (See below)

The minimum 5mm thickness is at the lowest point of the tray after the tray has been levelled.

Check that the top of the tray is level.

(Note the base of the tray has a built-in fall to allow for drainage).

In the case of a flat top shower tray, it is advised that all the tray to wall joints are now sealed with a bead of silicone sealant, once this has been done the walls can be tiled.

Ensure that you apply an additional bead of silicone sealant between the tray and the tiles, prior to fitting the wall channels.

### **How To Mix Up A Standard Mortar**

Mix 1 part ordinary cement to 5 parts soft sand. Mix the two together on a smooth hard surface. Measure the sand and then add the cement on top. Turn them together until they make a uniform colour. Make a crater and add water gradually. Turn the mix into the water to a flexible consistency. It must not be runny!

### **Installation Onto A Solid Or Restricted Access Floor.**

Where it is difficult to run a waste assembly under the floor, we recommend that you utilise our Universal Leg Set & Panel Kit. This is designed and specified for such installations to support the tray & give access to the waste behind removable panels.

# PEARLSTONE

## SHOWER TRAY FLAT TO FLOOR INSTALLATION

Thank you for purchasing your Pearlstone tray. Please fully read these installation procedures and familiarise yourself with the components before commencement.

Please inspect the product immediately and fully upon receipt and prior to installation for transit damage, or any defects. Damage or defects reported later cannot be accepted.

Your tray comes with a protective film. Peel back to inspect then replace.

Do not discard the packaging as some of it is utilised throughout the installation procedures.

### Fitting a Pearlstone shower tray to the floor.

For the best results & ease of installation determine the waste position of the tray.

Place the tray in the desired position or best location to simplify the installation.

The tray can be rotated indexing the waste to the most suitable position.

Fit the waste assembly & exit pipe work (following the waste manufacturers instruction & advice)

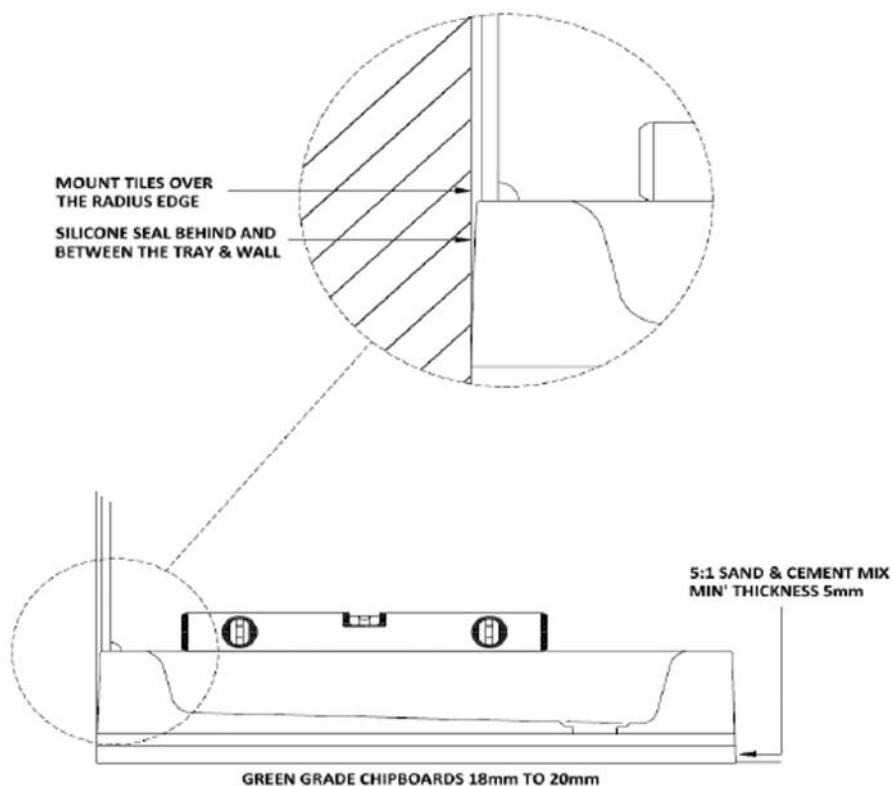

# PEARLSTONE

## UNIVERSAL LEG SET & PANEL KIT

Thank you for purchasing your Pearlstone tray. Please fully read these installation procedures and familiarise yourself with the components before commencement.

Please inspect the product immediately and fully upon receipt and prior to installation for transit damage, or any defects. Damage or defects reported later cannot be accepted.

Your tray comes with a protective film. Peel back to inspect then replace.

Do not discard the packaging as some of it is utilised through out the installation procedures.

---

### Assembly of the Universal Leg Set & Panel Kit

For the best results & ease of installation determine the waste position of the tray.

Place the tray in the desired position or best location to simplify the installation.

The tray can be rotated indexing the waste to the most suitable position.

Fit the waste assembly & exit pipe work (following the waste manufacturers instruction & advice)

Place the tray face down on a protective surface or packaging.

See over the page and check your size & type of product.

Align the legs and panel clips to the diagram overleaf which suits your product.

Your Pearlstone tray is supported by a new reinforcement material with the ability to screw into.

Secure each leg with x3 (13mm) 1/2" x No8 round headed screws provided.

**Under no circumstances use a longer screw for fixing into the base.**

Adjust the leg so that the overall assembly is a 100mm to suit the panel location and lightly tighten the hexagonal nut.

Depending on which leg clip has been supplied, screw the panel clips to the underside of the tray as illustrated overleaf. **It is important that the correct screw size is used for this operation.**

We recommend that the metal clip is fitted so that it overhangs the tray 4mm.

The plastic clip should be fitted to suit the panel return depth as this may vary.

**Note!** When moving your tray into position, do not slide as this can loosen the leg fixings.

In most cases, your plastic panel(s) is supplied over length.

Place onto the clips following the contour of the product if applicable.

Mark the panel to length at each end & cut accurately to length with a fine toothed saw.

Remove the panel.

Turn over the tray & adjust the adjustable feet to level the tray. Fit the panel which is 100mm in height into its desired location.

Check with a spirit level that the tray is correctly levelled and fully tighten the hexagonal nuts on the legs.

Scribe a line on the floor where the panel will sit.

Fit to the floor behind the scribed line taking account of the panel return lip. Fit several small blocks of wood (not supplied) to ensure the panel remains stable.

It is recommended that the legs at the front of the tray are screwed to the floor.

Special care should be taken when using power tools & when drilling take care to avoid hidden pipes or electrical cables.

### SQUARE TRAYS

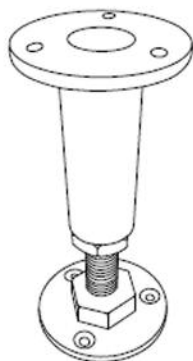
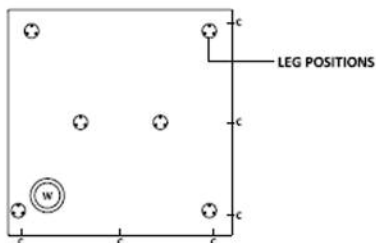

ADJUSTABLE FOOT (x6)



SCREWS 1/2" x No 8 RH (x18)

### EQUAL QUADRANT TRAYS

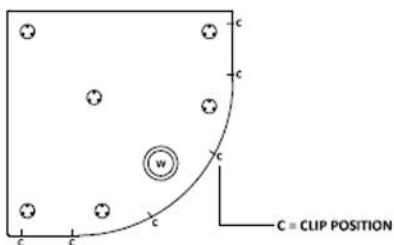

### OFFSET QUADRANT TRAYS

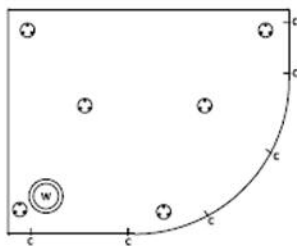

### RECTANGULAR TRAYS

Length 1000, 1100 & 1200mm Long

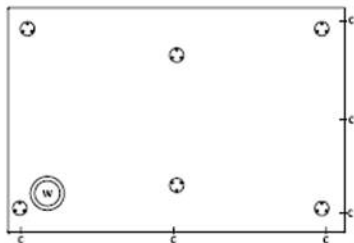

### LARGE RECTANGULAR TRAYS

Length 1400, 1500, 1600 & 1700mm Long

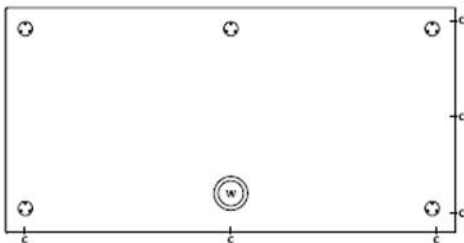

PLASTIC PANEL CLIPS (x6)



SCREWS 1" x No 8 RH (x12)



METAL PANEL CLIPS (x6)



SCREWS 1/2" x No 8 RH (x12)

ON RECTANGULAR TRAYS, ENSURE THE PANEL CLIPS ARE FITTED TO THE SIDE REQUIRING PANELS. THIS IS DEPENDENT ON THE WASTE POSITION.

# SHOWER TRAY FLAT TO FLOOR INSTALLATION

Please fully read these installation procedures and familiarise yourself with the components before commencement.

Please inspect the product immediately and fully upon receipt and prior to installation for transit damage, or any defects. Damage or defects reported later cannot be accepted.

Your tray comes with a protective film. Peel back to inspect then replace.

Do not discard the packaging as some of it is utilised throughout the installation procedures.

Note! Weights may vary due to the manufacturing process by +/- 10% of the stated weight.

An amount of deviation can be expected on this type of product especially on the larger trays.

---

## Shower Tray installation onto a timber floor.

It is recommended that all flat top shower trays are installed before tiling to ensure that the top radius of the tray is behind or at least below the tile face. This will help to create a water tight seal. (see diagram overleaf)

Having selected where the tray is to be fitted, check to make sure the area is reasonably level. (Fig 1)

Carefully lower the tray into the chosen position, and mark the floor for the waste opening. (Fig 2)

Remove the tray.

Check below the floor level to ensure that there is adequate access for the waste and pipe work.

If an obstruction is found, drill a hole and make provision in the floor of a sufficient diameter to allow the entire waste coupling to fall below the floor level.

Make sure the floorboards are securely fixed. If this is not possible, use 18/20mm thick green grade chipboard, cut to the size of the tray and fix in place.

Caution!! Before attempting to secure any loose floorboards or the chipboard to the floorboards, check that there are no pipes or electrical connections beneath the floor level.

Seal the installation area with a suitable clear waterproofing agent.

Fit the waste and trap to the tray following the manufacturers instruction.

It is recommended that you use a suitable silicone sealant around the waste to create a watertight seal.

Ensure that the entire base of the tray is fully supported as the base of the tray may not be entirely level.

This is due to the manufacturing process

So that the tray is bedded completely level the tray area has to be FULLY COVERED with a 8mm minimum thickness of weak cement mix (Fig 3)

The minimum thickness of mortar at the lowest point should be 5mm after the tray has been levelled.

Check that the top of the tray is level. (Fig 4)

(Note the base of the tray has a built-in fall to allow for drainage).

## How To Mix Up A Standard Mortar

Mix 1 part ordinary cement to 5 parts soft sand. Mix the two together on a smooth hard surface.

Measure the sand and then add the cement on top. Turn them together until they make a uniform colour. Make a crater and add water gradually. Turn the mix into the water to a flexible consistency.

It must not be runny!

In the case of a flat top shower tray, it is advised that all the tray to wall joints are now sealed with a bead of silicone sealant, once this has been done the walls can be tiled. Ensure that you apply an additional bead of silicone sealant between the tray and the tiles, prior to fitting the wall channels. (Fig 5)

## Installation Onto A Solid Or Restricted Access Floor.

Where it is difficult to run a waste assembly under the floor, we recommend that you utilise our Universal Leg Set & Panel Kit. This is designed and specified for such installations to support the tray & give access to the waste behind removable panels.

Note! For all trays fitted with 'easy plumb' leg kits, we recommend that you baton the wall to add additional support.

For trays 1400mm and above, additional support must be given by a cut 11mm (Min) thick board (Not Supplied) to suit the size of tray and allow enough space for the plinth clips to be fitted. Fix panel to the underside using a compound adhesive or similar.



FIG 1

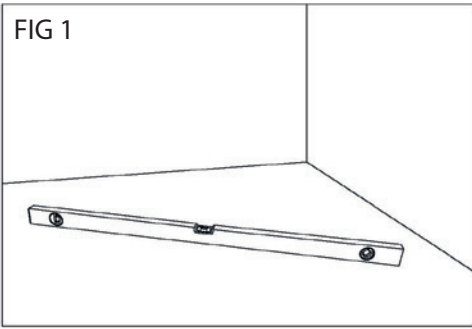

FIG 2

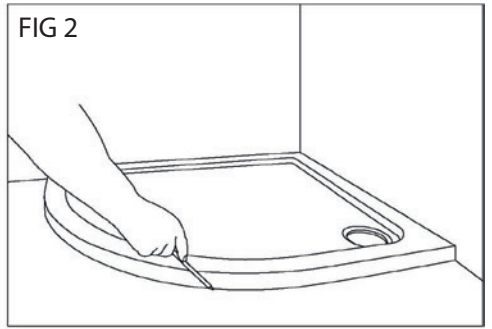

FIG 3

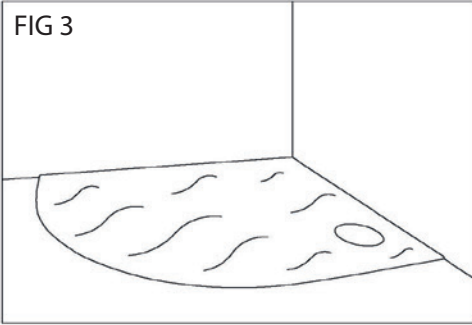

FIG 4

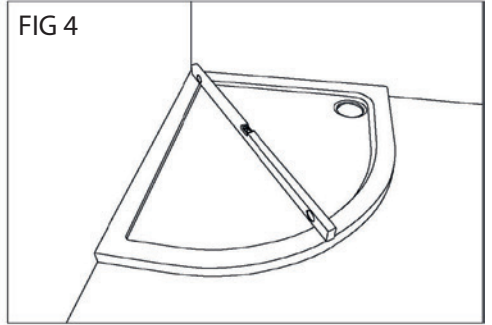
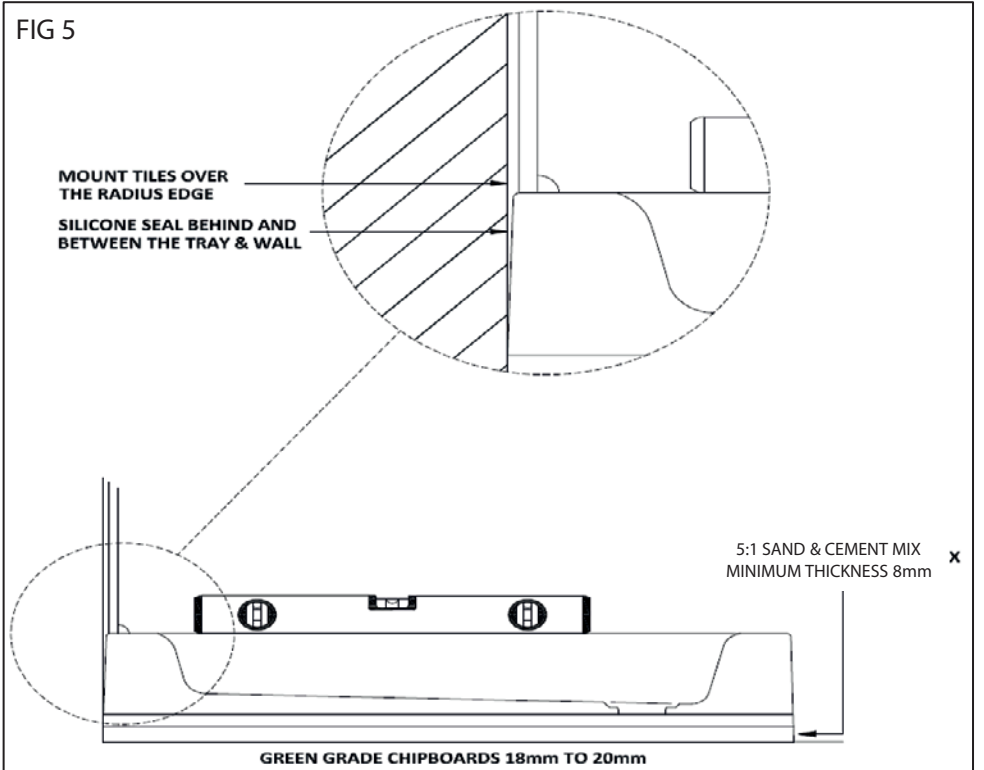

FIG 5





# UNIVERSAL LEG SET & PANEL KIT

Thank you for purchasing our tray. Please fully read these installation procedures and familiarise yourself with the components before commencement.

Please inspect the product immediately and fully upon receipt and prior to installation for transit damage, or any defects. Damage or defects reported later cannot be accepted.

Your tray comes with a protective film. Peel back to inspect then replace.

Do not discard the packaging as some of it is utilised through out the installation procedures.

---

## Assembly of the Universal Leg Set & Panel Kit

For the best results & ease of installation determine the waste position of the tray.

Place the tray in the desired position or best location to simplify the installation.

The tray can be rotated indexing the waste to the most suitable position.

Fit the waste assembly & exit pipe work (following the waste manufacturers instruction & advice)

Place the tray face down on a protective surface or packaging.

See over the page and check your size & type of product.

Align the legs and panel clips to the diagram overleaf which suits your product.

Note! All trays 1400mm and above require x2 'easy plumb' leg kits.

Your tray is supported by a new reinforcement material with the ability to screw into.

Secure each leg with x3 (13mm) 1/2" x No8 round headed screws provided.

Under no circumstances use a longer screw for fixing into the base.

Adjust the leg so that the overall assembly is a 100mm to suit the panel location and lightly tighten the hexagonal nut.

Depending on which leg clip has been supplied, screw the panel clips to the underside of the tray as illustrated overleaf. It is important that the correct screw size is used for this operation.

We recommend that the metal clip is fitted so that it overhangs the tray 4mm.

The plastic clip should be fitted to suit the panel return depth as this may vary.

When moving your tray into position, do not slide as this can loosen the leg fixings.

In most cases, your plastic panel(s) is supplied over length.

Place onto the clips following the contour of the product if applicable.

Mark the panel to length at each end & cut accurately to length with a fine toothed saw.

Remove the panel.

Turn over the tray & adjust the adjustable feet to level the tray. Fit the panel which is 100mm in height into its desired location.

Check with a spirit level that the tray is correctly levelled and fully tighten the hexagonal nuts on the legs.

Scribe a line on the floor where the panel will sit.

Fit to the floor behind the scribed line taking account of the panel return lip. Fit several small blocks of wood (not supplied) to ensure the panel remains stable.

It is recommended that the legs at the front of the tray are screwed to the floor.

Special care should be taken when using power tools & when drilling take care to avoid hidden pipes or electrical cables.

Make all waste connections & after tiling seal the tray along the contact edges.

Check for water tightness and finally fit the panel(s)

**SQUARE TRAYS**

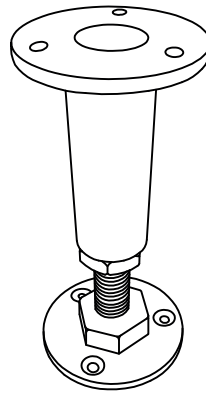
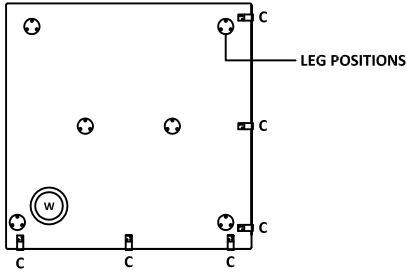

SCREWS 1/2" x No 8 RH (x18)

ADJUSTABLE FOOT (x6)

**EQUAL QUADRANT TRAYS**

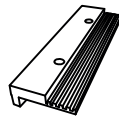
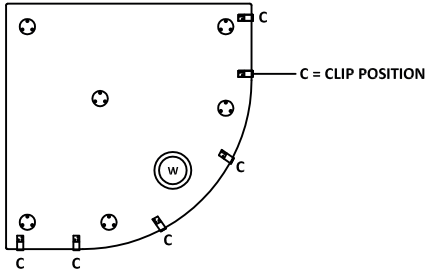

STRAIGHT PANEL CLIPS (x6)



METAL PANEL CLIPS (x6)

**OFFSET QUADRANT TRAYS**

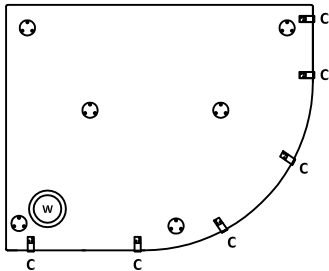

SCREWS 1" x No 8 RH (x12)



SCREWS 1/2" x No 8 RH (x12)

**RECTANGULAR TRAYS**

Length 1000, 1100 & 1200mm Long

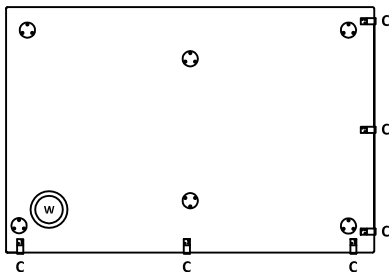

**LARGE RECTANGULAR TRAYS**

Length 1400, 1500, 1600 & 1700mm Long

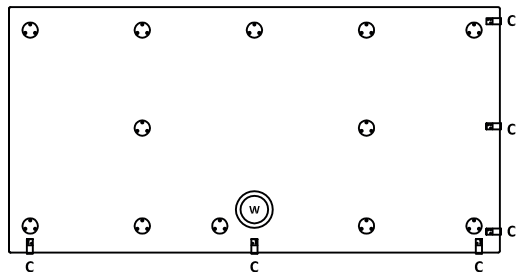

ON RECTANGULAR TRAYS, ENSURE THE PANEL CLIPS ARE FITTED TO THE SIDE REQUIRING PANELS. THIS IS DEPENDENT ON THE WASTE POSITION.