

Turbo Inline Fans

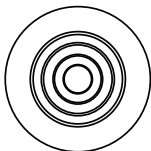

White - Non Illuminated
Art no. 33500

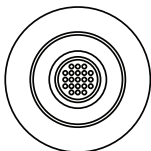

White - Cool White LED
Art no. 32200
White - Warm White LED
Art no. 34000

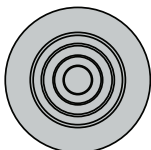

Chrome - Non Illuminated
Art no. 33600

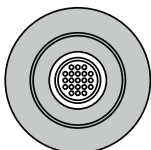

Chrome - Cool White LED
Art no. 32300
Chrome - Warm White LED
Art no. 33900

Thank you for purchasing this HiB product.

Please read through these instructions carefully and refer back to them during installation to ensure that your product is fitted safely and that it retains its high quality finish.

Please retain this leaflet for future reference.

Before drilling, ensure there are no hidden cables or pipes in the wall

Suitable for installation in zones: 2 & Outside Zones

Please see Fig. 1 on the back page for details

In The Box

1. 1x Fascia
2. 1x LED Driver
(32200, 34000, 32300 & 33900 only)
3. 1x High powered Inline fan
4. 1x 3 metre flexible ducting (Ø100mm)
5. 1x White external fixed grille
6. 4x Galvanized steel hose clamps
7. 1x Screw and dowels pack
8. 1x Plastic screwdriver
9. 1x Fitting instructions

Warning

The Turbo Illuminated Inline Fans (32200, 34000, 32300 & 33900) are supplied with an MR16 3 Watt LED lamp. This is the only lamp suitable for use with this fan. **Do not replace with any other lamp as this will invalidate any warranty. Do not exceed the stated wattage.**

The fan must be connected to power mains through an automatic circuit breaker integrated into the fixed wiring system with the gap between the breaker contacts on all poles not less than 3mm. Check the fan for any visible damages of the impeller and the casing before starting installation. The casing internals must be free of any foreign objects which can damage the impeller blades. Misuse of the product or any unauthorized modification is not allowed.

Take steps to prevent ingress of smoke, carbon monoxide and other combustion products into the room through open chimney flues or other fire-protection devices. Sufficient air supply must be provided for proper combustion and exhaust of gases through the chimney of fuel burning equipment to prevent back drafting.

Please Note; The fan may operate immediately when connected, this is normal and due to a residual charge left in the capacitor during testing. Should this occur, switch off, adjust timer to desired setting then turn back on. (see page 6 for Timer System)

Mounting - Fascia

1. Ceiling mounted ventilation should be ducted through the roof space, by ducting to an external soffit under the eaves or grille in the slope of your roof.
NB: Ducting installed between a floor and ceiling can only run between joists, not across them.
2. Mark the position of the vent fascia with a pencil in a suitable position on the ceiling, making sure that it is between the joists.
3. Drill a 9mm hole through the ceiling anywhere along the edge of the pencil line. Now cut out the hole with a pad saw.
4. Hold the vent fascia against the ceiling and mark the position of the fixing holes. Fix the unit in place using suitable heavy duty plasterboard fixings (not supplied).
5. Attach flexible ducting with the metal hose clamps. Ensure that the ducting has a smooth flow towards the motor body to minimise air resistance. Follow a similar procedure for the outside wall grille. *Extra ducting may be used to extend the distance to the external grille but performance will be reduced.*

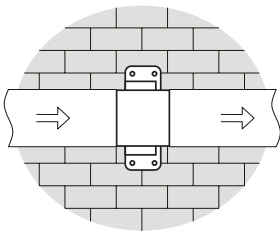

Fig. A horizontal on a wall

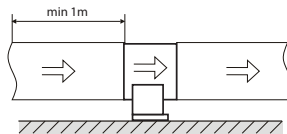
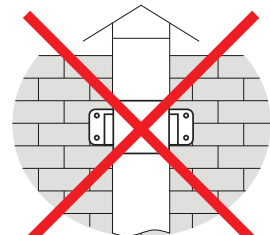

Fig. B horizontal on a floor



Do not mount vertically

Mounting - Fan unit

1. Install the Turbo Inline fan within the loft or ceiling space (ensuring correct direction of air flow using arrows on the fan). **DO NOT COVER motor or LED driver with loft insulation.** The fan is suitable for **only** horizontal mounting on a wall (fig. A) or a floor (fig. B). When mounting the fan ensure there is a minimum of 1m straight ducting to the motor body (see Fig B, p.3).
2. Place motor in desired location and mark fixing holes.
3. Fix motor to desired surface, using suitable wall plugs if necessary.

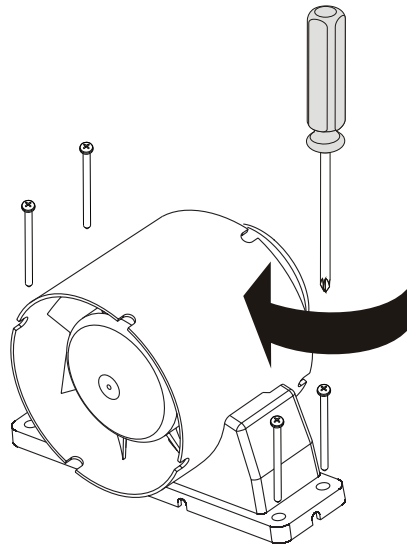
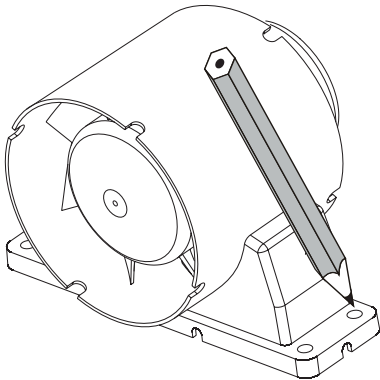

4. Connect the flexible ducting to both sides of the Inline fan with the metal hose clamps. Ensure there is a minimum of 1m straight ducting between fascia and fan.

Electrical Connection

1. Ensure the mains power supply to which the fan is being connected is turned off. This product is designed to be connected to an on/off switch outside the bathroom, or to a ceiling mounted pull cord switch.
2. Using a screw driver, remove cover.
3. Using a screw driver, remove cable grip. Feed cable through hole & replace grip.

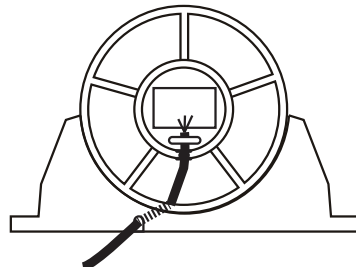
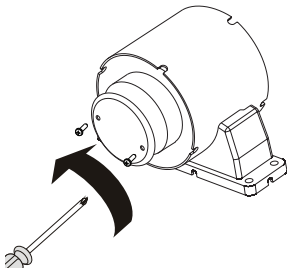

4. Wire the fan as per the diagram below.

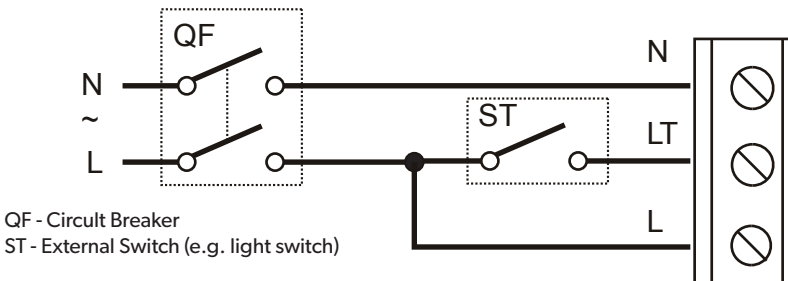

5. Replace cover using a suitable screw driver.
6. On Illuminated versions (32200, 34000, 32300 & 33900) the mains supply from the bathroom fitting should be connected to the LED driver as per the wiring diagram for lamp (see Fig. C, p.7).
7. Fix the external grille to the soffit in the same way as the ceiling fascia with 4 screws.

Timer System

Warning! The timer circuit is under mains voltage. Ensure mains power supply is switched off before making any adjustments.

The fan is operational after the control voltage is supplied by the external switch (e.g., by the light switch) to the input terminal LT. After the fan is switched off the fan continues to operate within the timer period set by the timer from 2 to 30 minutes. To adjust the run on timer, rotate the control knob clockwise to increase and anti-clockwise to decrease the off-delay time respectively (see below diagram). **Please note the adjustment should only be done without the fan running.**

The set includes a specially designed plastic screwdriver for timer setting adjustments. Only use the plastic screwdriver to alter the turn-off delay time. Do not use a screwdriver, knife, etc. for adjustments so as not to damage the circuit board.

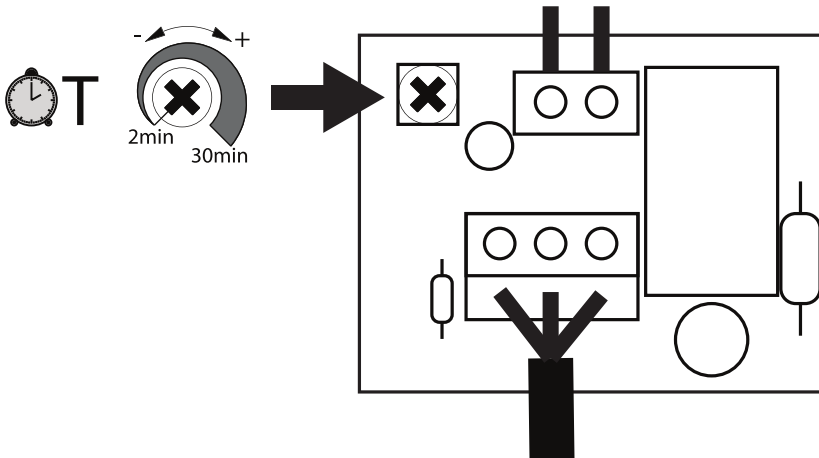

Wiring Diagram For Lamp

(32200, 34000, 32300 & 33900 only)

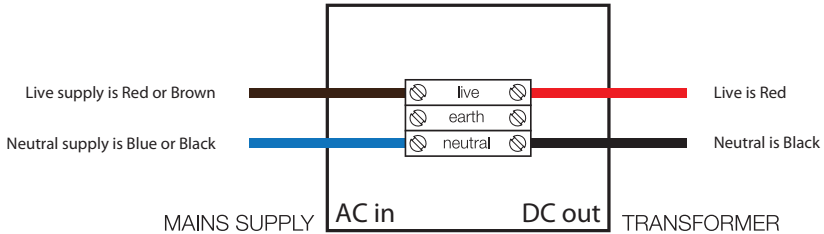

(Fig. C)

Operation

The fan is rated for connection to single-phase AC220-240 V / 50/60 Hz power mains. The fan is designed for continuous operation always connected to mains power. Air motion direction in the system must match the pointer on the fan casing. Ingress protection rating IPX4.

Maintenance

Fan maintenance is to be performed only after the fan is disconnected from the mains power supply. Maintenance means periodic cleaning of the surface of dust and dirt.

All surfaces should be cleaned with diluted detergent, i.e. washing up liquid, and a soft cloth. Scourers and scouring agents should not be used, as these may cause damage to the surface of the product.

Avoid water dripping on the electric components. Wipe the surfaces dry after cleaning.

Technical Information

Power Input: 220-240V, 50/60Hz

Maximum Ventilation Volume: 137m³/hr (±5%) / 38.056 Litres Per Second

Power Consumption: 16W + 3W LED Lamp (32200, 34000, 32300 & 33900)

Decibel: 37dB

Dimensions: Ø14 x D7.3cm



These products are suitable for installation in zones: **2 & Outside Zones**

All installations must comply with guidelines which are based on a zonal concept. The diagram above illustrates this concept and must be followed to ensure the safe installation of electrical appliances in the bathroom. These regulations apply to domestic installations only. Installations must be made in accordance with the current IEE wiring regulations and relevant building regulations. **HiB recommends that all electrical bathroom products should only be fitted by a suitably qualified, Part P registered electrician.**

Electrical Safety Information

Ensure mains power supply is switched off before starting installation. Before drilling, ensure there are no hidden cables or pipes in the wall.

Care Instructions

Do not use abrasives or solvents when cleaning this product.
Wipe off all water spillages as soon as possible using a soft, damp cloth.

Aftercare Service

In the unlikely event that this product should fail please contact HiB customer services, details shown below.



WEEE compliance

Must not be mixed with general household waste

T: +44 (0)20 8441 0352 F: +44 (0)20 8441 0219 E: sales@hib.co.uk hib.co.uk

Building 3, North London Business Park, Oakleigh Road South, New Southgate, London. N11 1GN

©HiB Copyright: No part of this document may be reprinted or duplicated without HiB consent. All sizes and measurements are approximate, but we do try and make sure they are as accurate as possible. In the interest of continuous product development, HiB reserves the right to alter specifications as necessary. E & OE.