















Space Saver Close Coupled Toilet VEN-PAN & CISTERN

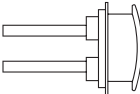
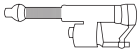
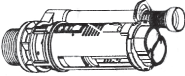
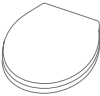

Assembly Instructions



What's in the Box

Reference	Description	Illustration	Quantity
A	cistern, cistern lid and cistern fittings (including push button)		1
B	Pan		1
C	Fixing Screws for Pan		2
D	Rawl Plugs		2
E	Washers for Floor Fixings		2
F	Screw Caps for Floor Fixings		2
G	Pan to Cistern Connecting Fixing Bolt		2
H	Dual Push Button		1
I	Cold Water Filling Valve		1
J	Cistern Flush Valve		1
K	Toilet Seat Lid and Seat		1
L	Stainless Steel Hinge Cover		2
M	Bolt		2
N	Seat Hinge		2
O	Lap Mat		2
P	Expension Bolt		2

Before You Begin

Tools Required:

- Adjustable spanner
- Drill
- Suitable drill bit
- Pencil
- Screwdriver
- Spirit level

Safety information

Vitreous china is fragile and should be handled with care.

Before you start

Check the pack and make sure you have all the parts listed.

If not, contact your vendor who will be able to help you.

When you are ready to start, make sure that you have the right tools to hand, plenty of space and a clean, dry area for assembly.

Ensure that the water feed and waste connection points are positioned appropriately for the installation.

CAUTION: Care should always be taken when drilling into walls and floors to avoid any sunken wires or pipes.

Please note: although these instructions are comprehensive, it is always recommended that a technically competent installer should undertake installation.

Note for the installer

Protect toilet seat whilst fitting and do not place tools on seat during installation.

Care and Use

Clean using a soft damp cloth or warm soapy water only. Do not use scourers, abrasives or chemical cleaners.

For further assistance contact Customer Services on

Important Note

Do not use chemical cleaning agents or related products inside the cistern tank.

Assembling the Toilet

1. Remove lid from cistern. Push the supplied Pan and Cistern Fixing bolts through the sealing washers and then through the holes in the bottom of the cistern. Place the donut washer on the base of the cistern.
2. Position pan in place and loosely connect the soil pipe to the waste outlet connection. Carefully place the cistern on top of the pan. Do not secure at this stage.
3. Check that the cistern is level using a spirit level. If you are securing the cistern to the wall [Optional], mark the holes on the wall through the back of the cistern.
4. Remove the cistern from the pan. If you are securing it to the wall, drill the holes in the wall and plug with wall plugs (not supplied).
5. Mark the position of the pan on the floor through the fixing holes on either side of the pan and trace an outline around the base. Remove the pan to gain access to the floor.
6. Using an appropriate drill bit, drill the holes for the base as per the marked positions. Plug using supplied rawl plugs.
7. Position pan in place again, lining up with marked outline. Connect the soil pipe and waste outlet connection securely. Screw the supplied bolt fixings and washers into the floor through the base of the pan. Once secured, cover with supplied screw caps.
8. Place the cistern on top of the pan. Tighten the bolts from the underside of the pan until the cistern is secured in place, do not over tighten.
9. Connect the water supply.
10. Check for leaks. Tighten and seal as appropriate. Although cistern fittings may be pre-fitted, check and tighten where necessary, applying PTFE tape and/or silicone as and where necessary.

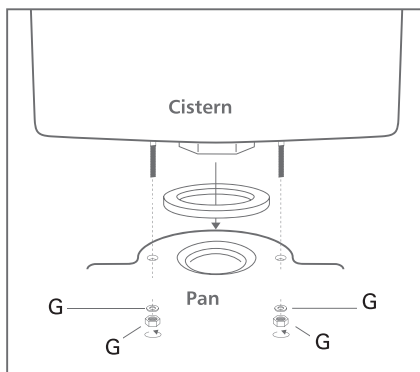
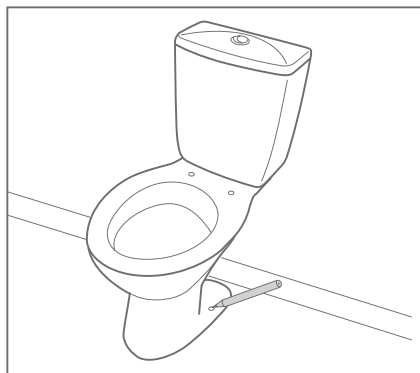
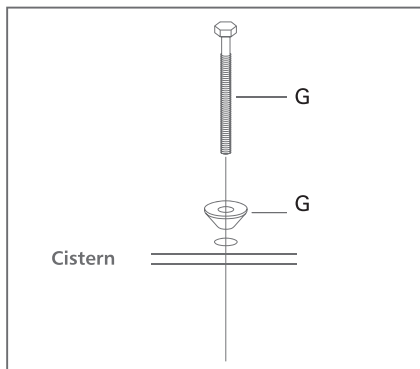

Installing Cistern Valves

The fill valve and the flush valve are already installed and adjusted but if changes need to be made refer to the following guide.

Fill Valve Installation

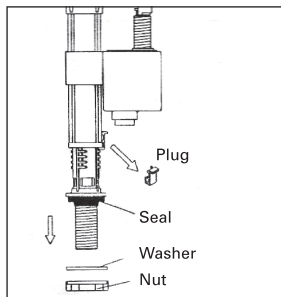

1. Assemble as per diagram. Remove the plug and adjust the height of the fill valve by turning the body in an anticlockwise direction. Set the desired height and turn the body in a clockwise direction, reinstall the plug.

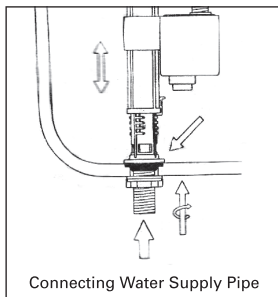

2. Please ensure the valve can move freely and does not come into contact with the walls of the cistern.

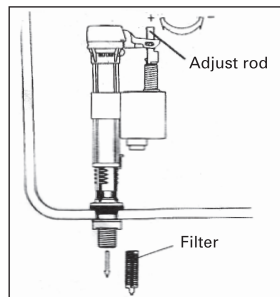

3. The float of the fill valve is adjustable up/down by turning the adjuster rod. The recommended maximum adjustment should be 20mm below that level.

Flush Valve Installation

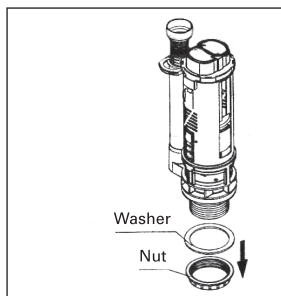

1. Position the flush valve in the cistern as shown ensuring a water seal is made with the sealing washer on the inside.

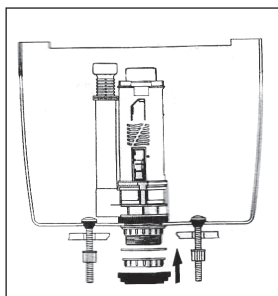

2. Assemble the connecting WC pan bolts and ensure the rubber gasket is in position to make a connecting seal.

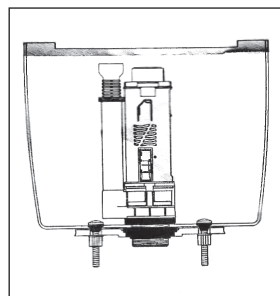

3. Secure the cistern to the WC pan by tightening the screws on the bolts.

Flush Valve Adjustments

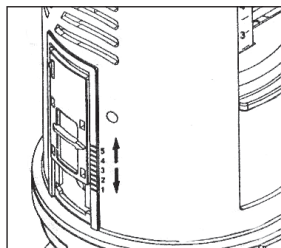

1. Adjust the full flush volume by sliding the adjusting float up or down as indicated here.

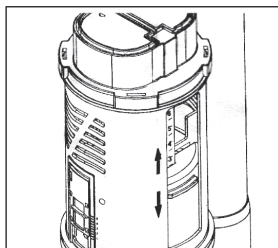

2. Adjust the half flush volume by sliding the adjusting float up or down as indicated here.

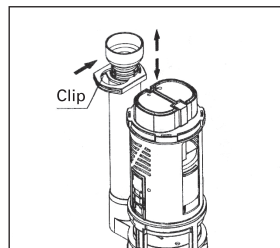

3. Adjust the overflow height by sliding the clip adjuster as indicated here.

Dual Flush Button Installation

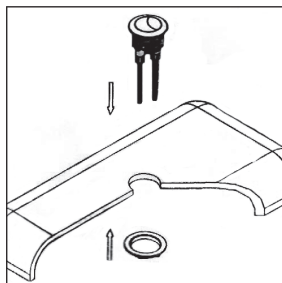

1. Unscrew the flanged nut.

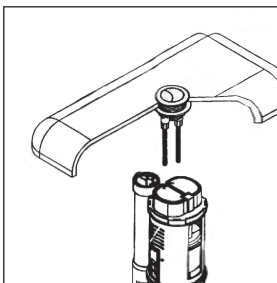

2. Insert the button into the lid hole of tank and then screw up the flanged nut.

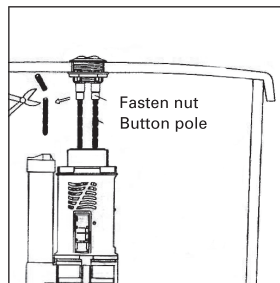

3. Cut the button rods to the desired length ensuring that they make only light contact with the dual flush valve contact areas.

Soft Close Toilet Seat Installation Instructions

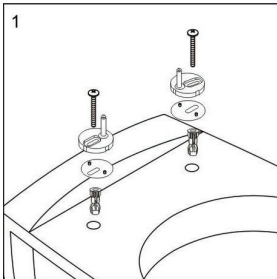
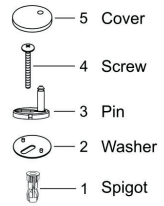

Insert the hinges into the toilet.

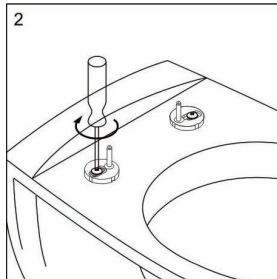

Tighten the screws in a clockwise direction (do not over tighten)

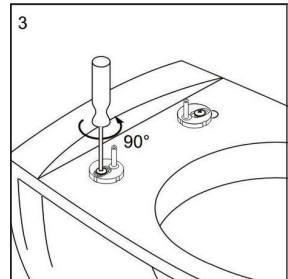

Untighten the screws a bit by turning them 90° in a anti-clockwise direction this will allow you to align the seat.

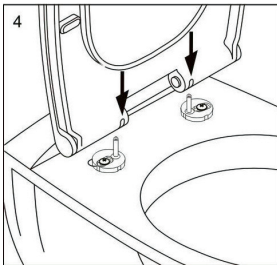

Clip on the toilet seat.

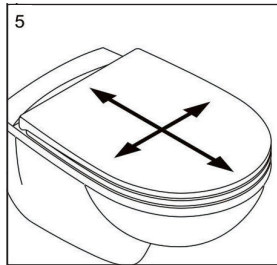

Align the toilet seat with ceramic bowl.

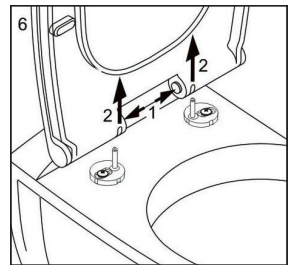

Take off the toilet seat by pressing both push buttons.

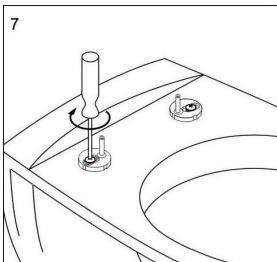

Tighten the screws in a clockwise direction

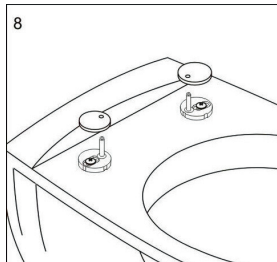

Place the cover over the hinges

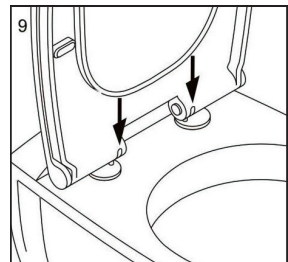

Clip on the toilet seat and cover.

